



böhlerwelding
by voestalpine

Lasting Connections

URANOS NX 2700 TLH

USER MANUAL





91.08.454
01/07/2024
B

ENGLISH.....	6
ITALIANO.....	42
DEUTSCH.....	78
FRANÇAIS.....	114
ESPAÑOL.....	150
PORTUGUÊS.....	186
NEDERLANDS.....	222
SVENSKA.....	258
DANSK.....	294
NORSK.....	330
SUOMI.....	366
ΕΛΛΗΝΙΚΑ.....	402

EN

IT

DE

FR

ES

PT

NL

SV

DA

NO

FI

EL

INDEX

1. WARNING.....	8
1.1 Work environment.....	8
1.2 User's and other persons' protection.....	8
1.3 Protection against fumes and gases.....	9
1.4 Fire/explosion prevention.....	9
1.5 Prevention when using gas cylinders.....	10
1.6 Protection from electrical shock.....	10
1.7 Electromagnetic fields and interferences.....	10
1.8 IP Protection rating.....	11
1.9 Disposal.....	12
2. INSTALLATION.....	12
2.1 Lifting, transport & unloading.....	12
2.2 Positioning of the equipment.....	12
2.3 Connection.....	12
2.4 Installation.....	13
3. SYSTEM PRESENTATION.....	14
3.1 Rear panel.....	14
3.2 Sockets panel.....	14
3.3 Front control panel.....	15
4. EQUIPMENT USE.....	16
4.1 Starting Screen.....	16
4.2 Main Screen.....	16
4.3 MMA process main screen.....	16
5. SETUP.....	20
5.1 Parameter set up and setting.....	20
5.2 Specific procedures parameters.....	27
6. MAINTENANCE.....	31
6.1 Carry out the following periodic checks on the power source.....	31
6.2 Responsibility.....	31
7. ALARM CODES.....	31
8. TROUBLESHOOTING.....	33
9. OPERATING INSTRUCTIONS.....	36
9.1 Manual Metal Arc welding (MMA).....	36
9.2 TIG welding (continuous arc).....	37
10. TECHNICAL SPECIFICATIONS.....	39
11. RATING PLATE.....	40
12. MEANING RATING PLATE.....	40
13. DIAGRAM.....	438
14. CONNECTORS.....	440
15. SPARE PARTS LIST.....	441

SYMBOLS

-  Warning
-  Prohibitions
-  Mandatory
-  General conditions

1. WARNING



Before performing any operation on the machine, make sure that you have thoroughly read and understood the contents of this booklet. Do not perform modifications or maintenance operations which are not prescribed. Do consult qualified personnel for any doubt or problem concerning the use of the machine, even if not described herein.

Do not perform modifications or maintenance operations which are not prescribed. The manufacturer cannot be held responsible for damages to persons or property caused by misuse or non-application of the contents of this booklet by the user.

The operating instructions must always be at hand wherever the device is being used. In addition to the operating instructions, attention must also be paid to any generally applicable and local regulations regarding accident prevention and environmental protection.

voestalpine Böhler Welding Selco S.r.l. s.r.l. reserves the right to modify this booklet at any time without notice.

All rights of translation and total or partial reproduction by any means whatsoever (including photocopy, film, and microfilm) are reserved and reproduction is prohibited without the explicit written consent of voestalpine Böhler Welding Selco S.r.l.

The directions provided herewith are of vital importance and therefore necessary to ensure the warranties.

The manufacturer accepts no liability in case of misuse or non-application of the directions by the users.



All persons involved in commissioning, operating, maintaining and servicing the device must:

- be suitably qualified
- have sufficient knowledge of welding
- read and follow these operating instructions carefully

Please consult qualified personnel if you have any doubts or difficulties in using the equipment.

1.1 Work environment



All equipment shall be used exclusively for the operations for which it was designed, in the ways and ranges stated on the rating plate and/or in this booklet, according to the national and international directives regarding safety. Other uses than the one expressly declared by the manufacturer shall be considered totally inappropriate and dangerous and in this case the manufacturer disclaims all responsibility.



This unit must be used for professional applications only, in industrial environments. The manufacturer will accept no responsibility for any damages caused by use in domestic environments.



The equipment must be used in environments with a temperature between -10°C and +40°C (between +14°F and +104°F).

The equipment must be transported and stored in environments with a temperature between -25°C and +55°C (between -13°F and 131°F).

The equipment must be used in environments free from dust, acid, gas or any other corrosive substances.

The equipment shall not be used in environments with a relative humidity higher than 50% at 40°C (104°F).

The equipment shall not be used in environments with a relative humidity higher than 90% at 20°C (68°F).

The system must not be used at a higher altitude than 2,000 metres (6,500 feet) above sea level.



Do not use this machine to defrost pipes.

Do not use this equipment to charge batteries and/or accumulators.

Do not use this equipment to jump-start engines.

1.2 User's and other persons' protection



The welding process is a noxious source of radiation, noise, heat and gas emissions. Position a fire-retardant shield to protect the surrounding welding area from rays, sparks and incandescent slags. Advise any person in the area of welding not to stare at the arc or at the incandescent metal and to get an adequate protection.



Wear protective clothing to protect your skin from the arc rays, sparks or incandescent metal. Clothes must cover the whole body and must be:

- intact and in good conditions
- fireproof
- insulating and dry
- well-fitting and without cuffs or turn-ups



Always use regulation shoes that are strong and ensure insulation from water.



Always use regulation gloves ensuring electrical and thermal insulation.



Wear masks with side face guards and a suitable protection filter (at least NR10 or above) for the eyes.



Always wear safety goggles with side guards, especially during the manual or mechanical removal of welding slag.



Do not wear contact lenses!



Use headphones if dangerous noise levels are reached during the welding. If the noise level exceeds the limits prescribed by law, delimit the work area and make sure that anyone getting near it is protected with headphones or earphones.



Always keep the side covers closed while welding. The system must not be modified in any way.



Avoid touching items that have just been welded: the heat could cause serious burning or scorching.



Follow all the precautions described above also in all operations carried out after welding since slag may detach from the items while they are cooling off.



Check that the torch is cold before working on or maintaining it.



Ensure the cooling unit is switched off before disconnecting the pipes of the cooling liquid. The hot liquid coming out of the pipes might cause burning or scorching.



Keep a first aid kit ready for use.
Do not underestimate any burning or injury.



Before leaving work, make the area safe, in order to avoid accidental damage to people or property.

1.3 Protection against fumes and gases



Fumes, gases and powders produced during the welding process can be noxious for your health.

Under certain circumstances, the fumes caused by welding can cause cancer or harm the foetus of pregnant women.

- Keep your head away from any welding gas and fumes.
- Provide proper ventilation, either natural or forced, in the work area.
- In case of poor ventilation, use masks and breathing apparatus.
- In case of welding in extremely small places the work should be supervised by a colleague standing nearby outside.
- Do not use oxygen for ventilation.
- Ensure that the fumes extractor is working by regularly checking the quantity of harmful exhaust gases versus the values stated in the safety regulations.
- The quantity and the danger level of the fumes depends on the parent metal used, the filler material and on any substances used to clean and degrease the pieces to be welded. Follow the manufacturer's instructions together with the instructions given in the technical data sheets.
- Do not perform welding operations near degreasing or painting stations.
- Position gas cylinders outdoors or in places with good ventilation.

1.4 Fire/explosion prevention



The welding process may cause fires and/or explosions.

- Clear the work area and the surrounding area from any flammable or combustible materials or objects.
- Flammable materials must be at least 11 metres (35 feet) from the welding area or they must be suitably protected.

- Sparks and incandescent particles might easily be sprayed quite far and reach the surrounding areas even through minute openings. Pay particular attention to keep people and property safe.
- Do not perform welding operations on or near containers under pressure.
- Do not perform welding or cutting operations on closed containers or pipes. Pay particular attention during welding operations on pipes or containers even if these are open, empty and have been cleaned thoroughly. Any residue of gas, fuel, oil or similar materials might cause an explosion.
- Do not weld in places where explosive powders, gases or vapours are present.
- When you finish welding, check that the live circuit cannot accidentally come in contact with any parts connected to the earth circuit.
- Position a fire-fighting device or material near the work area.

1.5 Prevention when using gas cylinders



Inert gas cylinders contain pressurized gas and can explode if the minimum safe conditions for transport, storage and use are not ensured.

- Cylinders must be secured in a vertical position to a wall or other supporting structure, with suitable means so that they cannot fall or accidentally hit anything else.
- Screw the cap on to protect the valve during transport, commissioning and at the end of any welding operation.
- Do not expose cylinders to direct sunlight, sudden changes of temperature, too high or extreme temperatures. Do not expose cylinders to temperatures too low or too high.
- Keep cylinders away from naked flames, electric arcs, torches or electrode guns and incandescent material sprayed by welding.
- Keep cylinders away from welding circuits and electrical circuits in general.
- Keep your head away from the gas outlet when opening the cylinder valve.
- Always close the cylinder valve at the end of the welding operations.
- Never perform welding operations on a pressurized gas cylinder.
- A compressed air cylinder must never be directly coupled to the machine pressure reducer! Pressure might exceed the capacity of the reducer which could consequently explode!

1.6 Protection from electrical shock



Electric shocks can kill you.

- Avoid touching live parts both inside and outside the welding system while this is active (torches, guns, earth cables, electrodes, wires, rollers and spools are electrically connected to the welding circuit).
- Make sure that the welding system and the welder are electrically isolated by using dry bases and floors that are adequately isolated from earth.
- Ensure the system is connected correctly to a socket and a power source equipped with an earth conductor.
- Do not touch two torches or two electrode holders at the same time.
- If you feel an electric shock, interrupt the welding operations immediately.



The arc striking and stabilizing device is designed for manual or mechanically guided operation.



Increasing the length of torch or welding cables more than 8 m will increase the risk of electric shock.

1.7 Electromagnetic fields and interferences



The current passing through the internal and external system cables creates an electromagnetic field in the proximity of the welding cables and the equipment itself.

- Electromagnetic fields can affect the health of people who are exposed to them for a long time (the exact effects are still unknown).
- Electromagnetic fields can interfere with some equipment like pacemakers or hearing aids.



Persons fitted with pacemakers must consult their doctor before undertaking arc welding operations.

1.7.1 EMC classification in accordance with: EN 60974-10/A1:2015.

Class B

Class B equipment complies with electromagnetic compatibility requirements in industrial and residential environments, including residential locations where the electrical power is provided by the public low-voltage supply system.

Class A

Class A equipment is not intended for use in residential locations where the electrical power is provided by the public low-voltage supply system. There may be potential difficulties in ensuring electromagnetic compatibility of class A equipment in those locations, due to conducted as well as radiated disturbances.

For more informations, check the chapter: RATING PLATE or TECHNICAL SPECIFICATIONS.

1.7.2 Installation, use and area examination

This equipment is manufactured in compliance with the requirements of the harmonized standard EN 60974-10/A1:2015 and is identified as "CLASS A" equipment. This unit must be used for professional applications only, in industrial environments. The manufacturer will accept no responsibility for any damages caused by use in domestic environments.



The user must be an expert in the activity and as such is responsible for installation and use of the equipment according to the manufacturer's instructions. If any electromagnetic interference is noticed, the user must solve the problem, if necessary with the manufacturer's technical assistance.



In any case electromagnetic interference problems must be reduced until they are not a nuisance any longer.



Before installing this equipment, the user must evaluate what electromagnetic problems it might cause in the surrounding area, with specific regard to the health of persons nearby, pace-maker and hearing aid users, for example.

1.7.3 Mains power supply requirements

The high current draw of high-power equipment can affect the quality of mains electrical energy. Connection restrictions or requirements regarding maximum permissible mains impedance (Z_{max}) or minimum supply capacity (S_{sc}) at the point of interface with the public grid (point of common coupling, PCC) may apply for certain types of equipment (see technical data). In this case it is the responsibility of the installer or user of the equipment to ensure, by consultation with the distribution network operator if necessary, that the equipment may be connected. In case of interference, it may be necessary to take further precautions like the filtering of the mains power supply.

It is also necessary to consider the possibility of shielding the power supply cable.

For more informations, check the chapter: TECHNICAL SPECIFICATIONS.

1.7.4 Precautions regarding cables

To minimise the effects of electromagnetic fields follow the following instructions:

- Where possible, collect and secure the earth and power cables together.
- Never coil the cables around your body.
- Do not place your body in between the earth and power cables (keep both on the same side).
- The cables must be kept as short as possible, positioned as close as possible to each other and laid at or approximately at ground level.
- Position the equipment at some distance from the welding area.
- The cables must be kept away from any other cables.

1.7.5 Earthing connection

The earth connection of all the metal components in the welding (cutting) equipment and in the close area must be taken in consideration. The earthing connection must be made according to the local regulations.

1.7.6 Earthing the workpiece

When the workpiece is not earthed for electrical safety reasons or due to its size and position, the earthing of the workpiece may reduce the emissions. It is important to remember that the earthing of the workpiece should neither increase the risk of accidents for the user nor damage other electric equipment. The earthing must be made according to the local regulations.

1.7.7 Shielding

The selective shielding of other cables and equipment present in the surrounding area may reduce the problems due to electromagnetic interference.

The shielding of the entire welding equipment can be taken in considered for special applications.

1.8 IP Protection rating

IP

IP23S

- Enclosure protected against access to dangerous parts by fingers and against ingress of solid bodies objects with diameter equal or greater than 12.5 mm.
- Enclosure protected against rain at an angle of 60°.
- Enclosure protected against harmful effects due to the ingress of water when the moving parts of the equipment are not operating.

1.9 Disposal



Do not dispose of electrical equipment together with normal waste!

In conformity to European Directive 2012/19/EU on Waste Electrical and Electronic Equipment and its implementation according to national law, electrical equipment must be collected separately and disposed of through an authorised recovery and disposal centre at the end of its life cycle. The owner of the equipment is required to identify authorised collection centres on the basis of the information provided by Local Authorities. By applying this European Directive you will improve the environment and human health!

» For further information, refer to the website.

2. INSTALLATION



Installation should be performed only by expert personnel authorised by the manufacturer.



During installation, ensure that the power source is disconnected from the mains.



The multiple connection of power sources (series or parallel) is prohibited.

2.1 Lifting, transport & unloading

• The equipment is provided with a handle for hand transportation.



Do not underestimate the weight of the equipment: see technical specifications.

Do not move or position the suspended load above persons or things.

Do not drop or apply undue pressure on the equipment.

2.2 Positioning of the equipment



Keep to the following rules:

- Provide easy access to the equipment controls and connections.
- Do not position the equipment in very small spaces.
- Do not place the equipment on surfaces with inclination exceeding 10° from to the horizontal plane.
- Position the equipment in a dry, clean and suitably ventilated place.
- Protect the equipment against pouring rain and sun.

2.3 Connection



The equipment is provided with a power supply cable for connection to the mains.

The system can be powered by:

- three-phase 230V
- three-phase 400V

Operation of the equipment is guaranteed for voltage tolerances up to $\pm 15\%$ with respect to the rated value.



To prevent injury to persons or damage to the equipment, the selected mains voltage and fuses must be checked BEFORE connecting the machine to the mains. Also check that the cable is connected to a socket provided with earth contact.



The equipment can be powered by a generating set provided it guarantees a stable power supply voltage of $\pm 15\%$ with respect to the rated voltage declared by the manufacturer, under all possible operating conditions including at maximum rated power. Normally we recommend the use of generating sets with twice rated power of a single phase power source or 1.5 times that of a three-phase power source. The use of electronic control type generating sets is recommended.



In order to protect users, the equipment must be correctly earthed. The power supply voltage is provided with an earth lead (yellow - green), which must be connected to a plug provided with earth contact. This yellow/green wire shall NEVER be used with other voltage conductors. Verify the existence of the earthing in the equipment used and the good condition of the sockets. Install only certified plugs according to the safety regulations.



The electrical connections must be made by skilled technicians with the specific professional and technical qualifications and in compliance with the regulations in force in the country where the equipment is installed.

2.4 Installation

2.4.1 Connection for MMA welding



The connection shown in the figure produces reverse polarity welding.
To obtain straight polarity welding, reverse the connection.

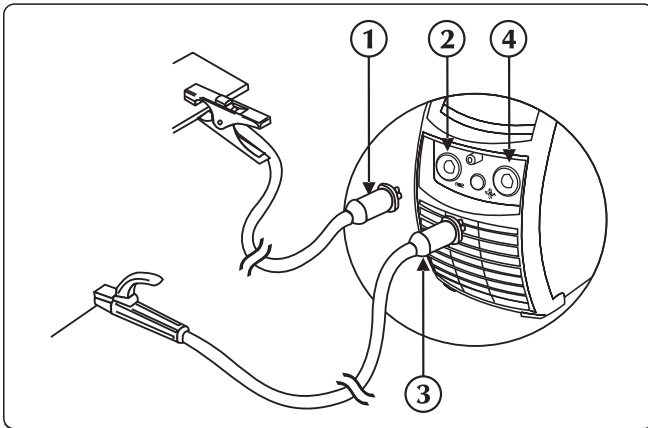



- ① Earth clamp connector
- ② Negative power socket (-)
- ③ Electrode holder clamp connector
- ④ Positive power socket (+)

- ▶ Connect the earth clamp to the negative socket (-) of the power source. Insert the plug and turn clockwise until all parts are secured.
- ▶ Connect the electrode holder to the positive socket (+) of the power source. Insert the plug and turn clockwise until all parts are secured.

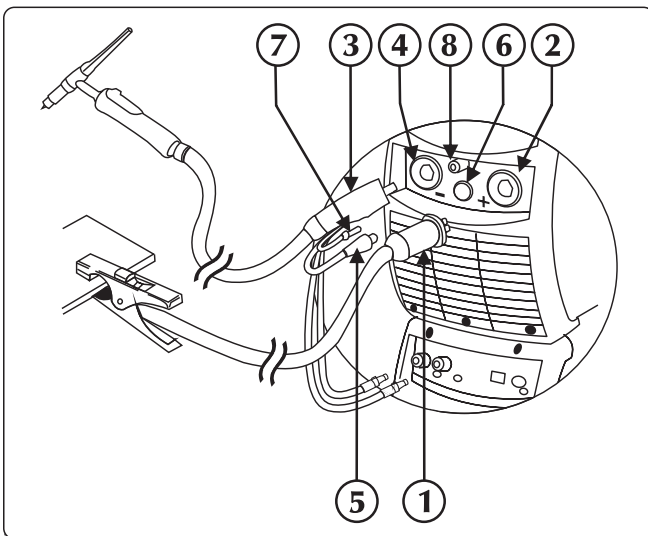
2.4.2 Connection for TIG welding



- ① Earth clamp connector
- ② Positive power socket (+)
- ③ TIG torch fitting
- ④ Torch socket
- ⑤ Torch signal cable
- ⑥ Connector
- ⑦ Torch gas tube
- ⑧ Gas union-connection

- ▶ Connect the earth clamp to the positive socket (+) of the power source. Insert the plug and turn clockwise until all parts are secured.
- ▶ Connect the TIG torch coupling to the torch socket of the power source. Insert the plug and turn clockwise until all parts are secured.
- ▶ Connect the signal cable of the torch to the appropriate connector.
- ▶ Connect the gas hose of the torch to the appropriate union/connection.
- ▶ Connect the water pipe (red coloured) of the torch to the inlet quick connector (red coloured - symbol ) of the cooling unit.
- ▶ Connect the water pipe (blue coloured) of the torch to the outlet quick connector (blue coloured - symbol ) of the cooling unit.

EN

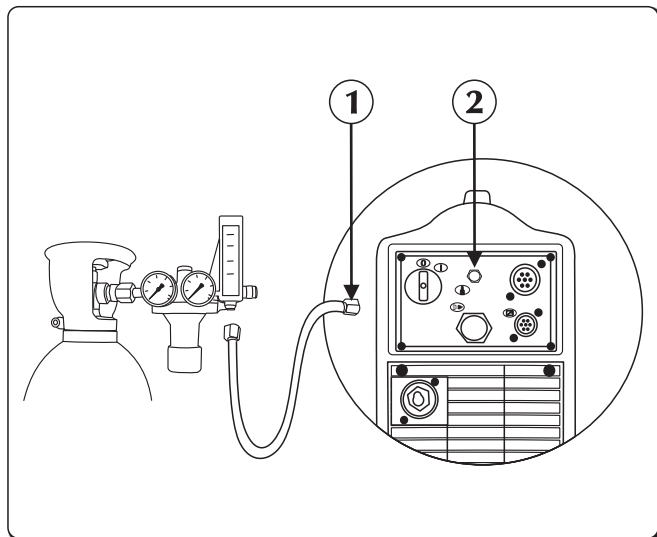

- ① Gas tube
- ② Gas union-connection

► Connect the gas hose from the cylinder to the rear gas connection. Adjust the gas flow from 5 to 15 l/min.

3. SYSTEM PRESENTATION

3.1 Rear panel

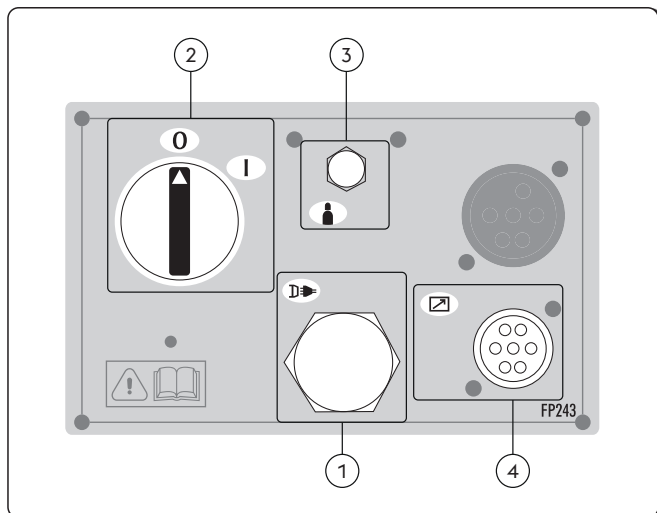

- ① Power supply cable
Connects the system to the mains.
- ② Off/On switch
Turns on electric power.
It has two positions, "0" off, and "I" on.
- ③ Gas fitting
- ④ Signal cable CAN-BUS input (RC, RI...)



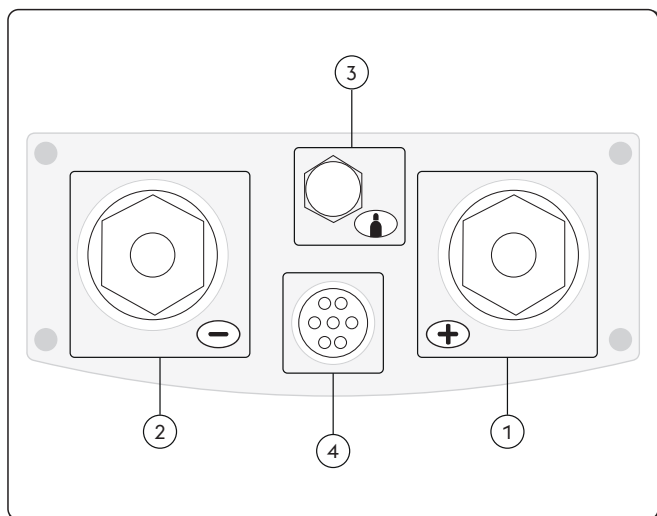



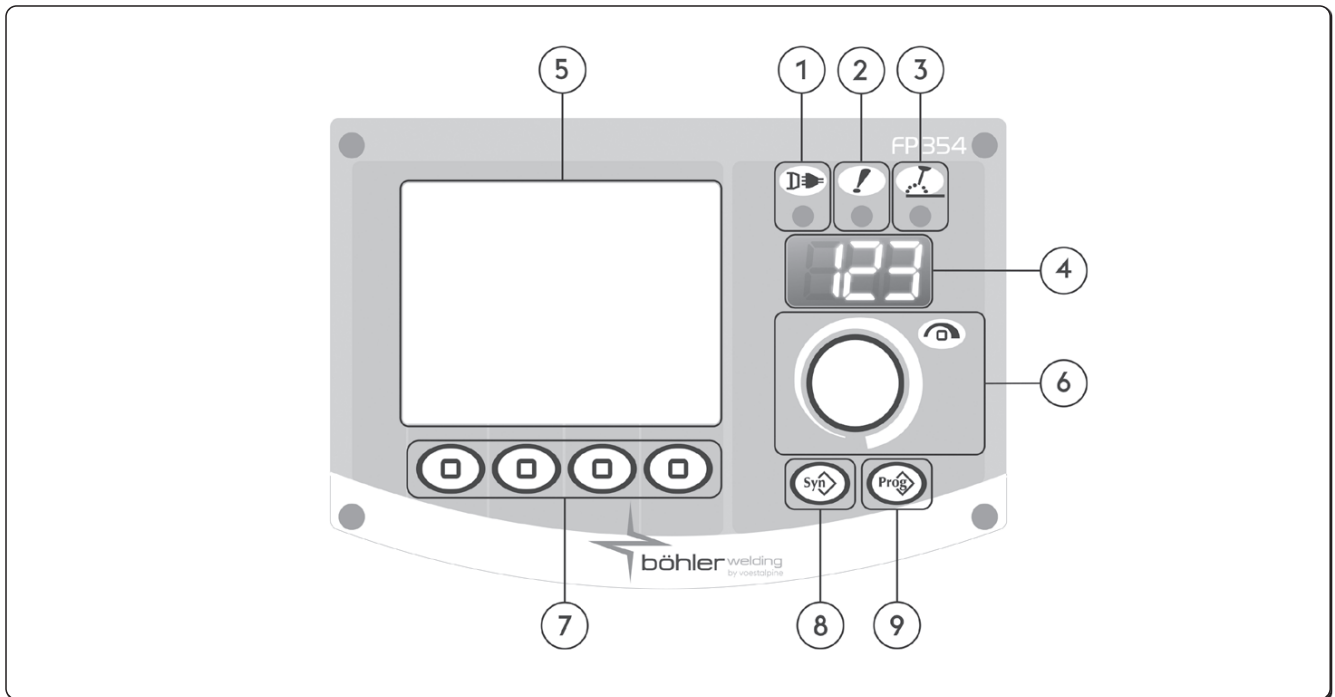

3.2 Sockets panel







- ① Positive power socket (+)
Process MMA: Connection electrode torch
Process TIG: Connection earth cable
- ② Negative power socket (-)
Process MMA: Connection earth cable
Process TIG: Torch connection
- ③ Gas fitting
- ④ Signal cable input (TIG torch)

3.3 Front control panel

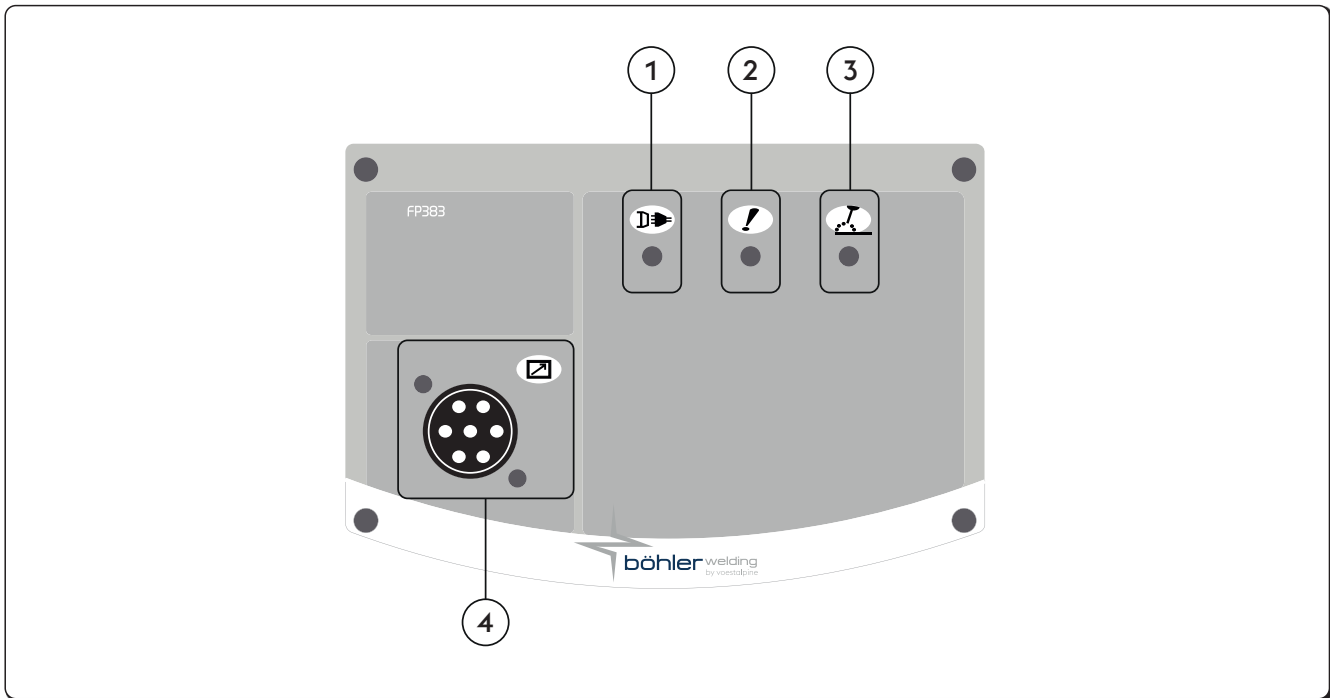

- 1  **Power supply LED**
Indicates that the equipment is connected to the mains and is on.
- 2  **General alarm LED**
Indicates the possible intervention of protection devices such as the temperature protection.
- 3  **Power on LED**
Indicates the presence of voltage on the equipment outlet connections.
- 4  **7-segment display**
Allows the general welding machine parameters to be displayed during start-up, settings, current and voltage readings, while welding, and encoding of the alarms.
- 5  **LCD display**
Allows the general welding machine parameters to be displayed during start-up, settings, current and voltage readings, while welding, and encoding of the alarms.
Allows all the operations to be displayed instantaneously.
- 6  **Main adjustment handle.**
Allows the welding current to be continuously adjusted.
Allows entry to set up, the selection and the setting of the welding parameters.
- 7  **Function keys**
Let you select the various system functions:
- MMA welding process
- Welding methods
- Current pulsation
- Graphic mode
- 8  **Key not used**
- 9  **Job key**
Allows the storage and management of 240 jobs which can be personalised by the operator.



- ①  **Power supply LED**
Indicates that the equipment is connected to the mains and is on.
- ②  **General alarm LED**
Indicates the possible intervention of protection devices such as the temperature protection.
- ③  **Power on LED**
Indicates the presence of voltage on the equipment outlet connections.
- ④  **Signal cable CAN-BUS input (RC, RI...)**

4. EQUIPMENT USE

4.1 Starting Screen

When switched on, the system performs a series of self-tests to verify its own correct functioning and that of the devices connected to it. At this stage the gas test is also carried out to check the proper connection to the gas supply system.

4.2 Main Screen

Allows the control of the system and of the welding process, showing the main settings.

4.3 MMA process main screen

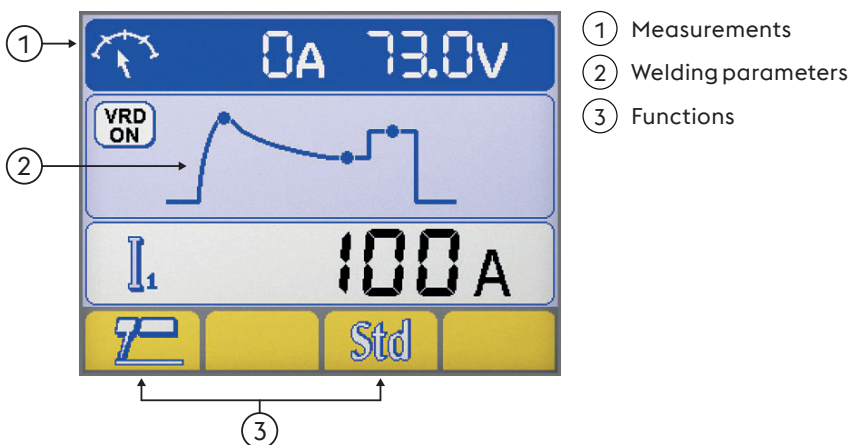

Measurements

During the welding operation, the real current and voltage measurements are shown on the LCD display.

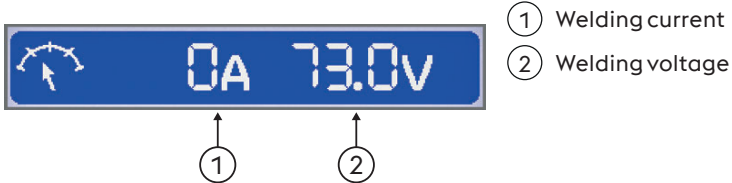

- ① Welding current
- ② Welding voltage

Welding parameters

▶ Select the required parameter by pressing the encoder button.

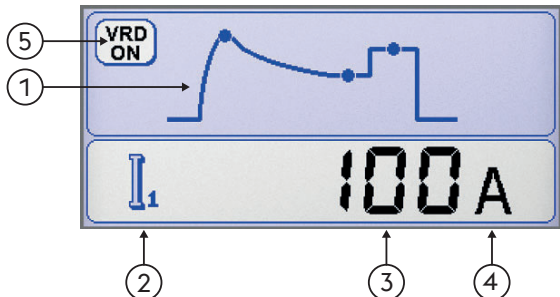

- ① Welding parameters
- ② Parameter icon
- ③ Parameter value
- ④ Unit of measurement of the parameter
- ⑤ VRD (Voltage Reduction Device)
Voltage Reduction Device
Shows that the no-load voltage of the equipment is controlled.

Functions

Allow the setting of the most important process functions and welding methods.



- ① MMA welding process
- ② MMA synergy



MMA welding process



MMA synergy

Allows you to set the best arc dynamics, selecting the type of electrode used. Selecting the correct arc dynamics enables maximum benefit to be derived from the power source to achieve the best possible welding performances.



Perfect weldability of the electrode used is not guaranteed
Weldability depends on the quality of the consumables and their conservation, on the operating methods and on the welding conditions, on the numerous possible applications.

4.4 TIG process main screen

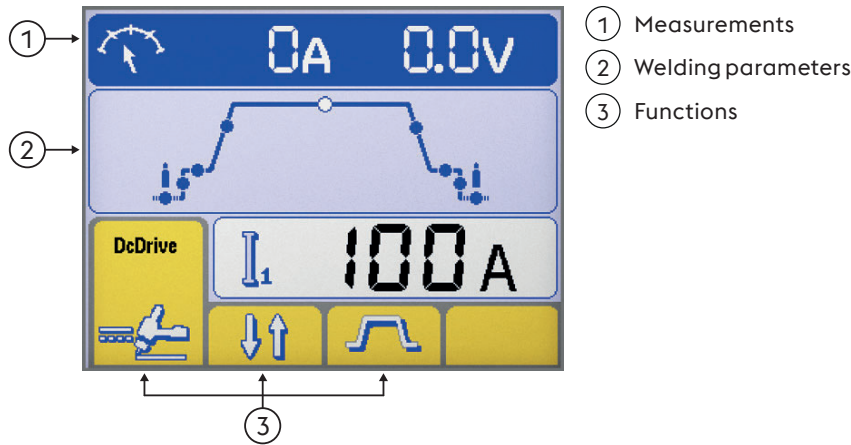

- ① Measurements
- ② Welding parameters
- ③ Functions

Measurements

During the welding operation, the real current and voltage measurements are shown on the LCD display.

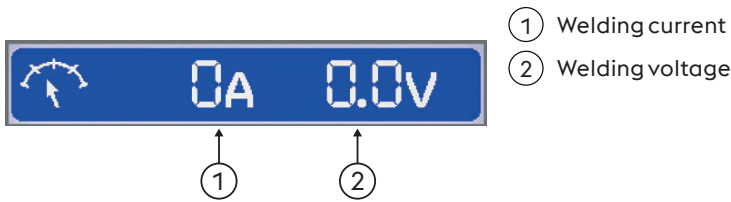

- ① Welding current
- ② Welding voltage

Welding parameters

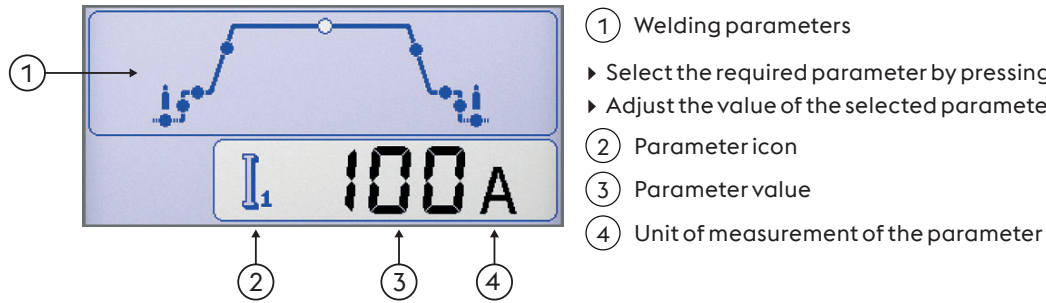

- ① Welding parameters
 - ▶ Select the required parameter by pressing the encoder button.
 - ▶ Adjust the value of the selected parameter by rotating the encoder.
- ② Parameter icon
- ③ Parameter value
- ④ Unit of measurement of the parameter

Functions

Allow the setting of the most important process functions and welding methods.

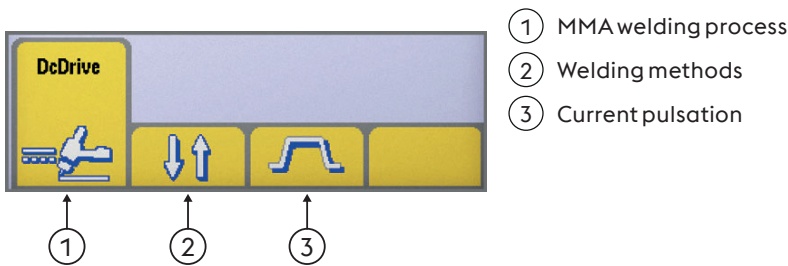

- ① MMA welding process
- ② Welding methods
- ③ Current pulsation

MMA welding process



Welding methods

Allows the selection of the welding method

- ② Step
 - In 2 Step, pressing the button causes the gas to flow and strikes the arc; when the button is released the current returns to zero in the slope descent time; once the arc is extinguished, the gas flows for the post-gas time.



4 Step

This button functions in four steps. The first press of the button starts the gas flow, performing a manual pre-gas. Releasing the button strikes the arc. Pressing and releasing the button again initiates current slope descent and starts post-gas time.



Bilevel

In bilevel mode, you can weld using the two current levels set previously. The first pressure on the button leads to the pre-gas time, the striking of the arc and welding with the initial current. The first release leads to the current slope-up "I1". If the welder presses and releases the button quickly, there is a change to "I2". Pressing and releasing the button quickly returns to "I1" and so on. If you press the button for a longer time, the lowering ramp for the current starts, thus reaching the final current. Releasing the button extinguishes the arc while the gas continues to flow for the post-gas time.



Current pulsation



Constant current



Pulsed current



Fast Pulse



EasyArc

4.5 Programs screen



Allows the storage and management of 240 jobs which can be personalised by the operator.

Programs (JOB)

See the "Main screen" section

Program storage

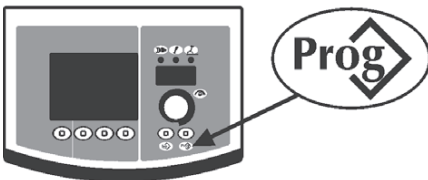

▶ Enter the "program storage" menu by pressing button for at least a second.



▶ Select the required program (or the empty memory) by rotating the encoder.

--- Memory empty

Program stored

▶ Cancel the operation by pressing button .

▶ Save all the current settings on the selected program by pressing button .

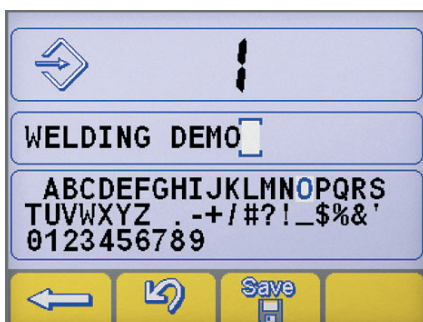

Introduce a description of the program.

▶ Select the required letter by rotating the encoder.

▶ Store the selected letter by pressing the encoder.

▶ Press the button to delete the last letter. .

▶ Cancel the operation by pressing button .

▶ Confirm the operation by pressing button .



The storage of a new program on an already occupied memory location requires cancellation of the memory location by an obligatory procedure.

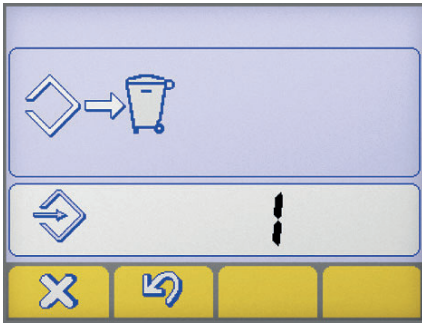

- ▶ Cancel the operation by pressing button
- ▶ Remove the selected program by pressing button.
- ▶ Resume the storage procedure.

Program retrieval

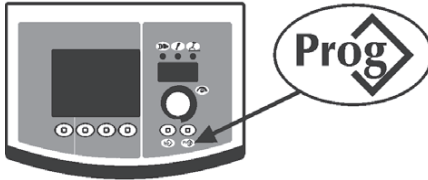

- ▶ Retrieve the 1st program available by pressing button
 - ▶ Select the required program by rotating the encoder.
 - ▶ Select the required program by pressing button.
- Only the memories location occupied by a program are retrieved, while the empty ones are automatically skipped.

Program cancellation



- ▶ Select the required program by rotating the encoder.
- ▶ Remove the selected program by pressing button.
- ▶ Cancel the operation by pressing button



- ▶ Cancel the operation by pressing button
- ▶ Remove the selected program by pressing button.

5. SETUP

5.1 Parameter set up and setting

Permits set-up and adjustment of a series of additional parameters for improved and more accurate control of the welding system.

The parameters present at set up are organised in relation to the welding process selected and have a numerical code.

Entry to set up





- ▶ By pressing the encoder button for 5 seconds.
- ▶ The entry will be confirmed by the writing 0 on the display

Selection and adjustment of the required parameter

- ▶ Rotate the encoder until you display the numerical code for the required parameter.
- ▶ If the encoder key is pressed at this point, the value set for the parameter selected can be displayed and adjusted.

Exit from set up

- ▶ To quit the "adjustment" section, press the encoder again.
- ▶ To exit the set-up, go to parameter "0" (save and quit) and press encoder key.
- ▶ Cancel the operation by pressing button .
- ▶ To save the change and exit the set up, press the key: .

5.1.1 List of set up parameters (MMA)

0 Save and Exit



Allows you to save the changes and exit the set up.

1 Reset



Allows you to reset all the parameters to the default values.

3 Hot start



Allows adjustment of the hot start value in MMA.

Permits an adjustable hot start in the arc striking phases, facilitating the start operations.

Basic electrode

Minimum	Maximum	Default
0/off	500%	80%

Cellulosic electrode

Minimum	Maximum	Default
0/off	500%	150%

CrNi electrode

Minimum	Maximum	Default
0/off	500%	100%

Aluminum electrode

Minimum	Maximum	Default
0/off	500%	120%

Cast Iron electrode

Minimum	Maximum	Default
0/off	500%	100%

Rutile electrode

Minimum	Maximum	Default
0/off	500%	80%

7 Welding current

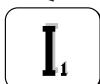

Allows the regulation of the welding current.

Minimum	Maximum	Default
3 A	I _{max}	100 A

8 Arc force



Allows adjustment of the Arc force value in MMA.

Permits an adjustable energetic dynamic response in welding, facilitating the welder's operations.

Increase the value of the Arc force to reduce the risk of electrode sticking.

Basic electrode

Minimum	Maximum	Default
0/off	500%	30%

Cellulosic electrode

Minimum	Maximum	Default
0/off	500%	350%

CrNi electrode

Minimum	Maximum	Default
0/off	500%	30%

Aluminum electrode

Minimum	Maximum	Default
0/off	500%	100%

Cast Iron electrode

Minimum	Maximum	Default
0/off	500%	70%

Rutile electrode

Minimum	Maximum	Default
0/off	500%	80%

204 Dynamic power control (DPC)



It enables the desired V/I characteristic to be selected.

I=C Constant current

The increase or reduction in arc length has no effect on the welding current required.

Recommended for electrode: Basic, Rutile, Acid, Steel, Cast iron

1÷20 Falling characteristic with adjustable slope

The increase in arc length causes a reduction in welding current (and vice versa) according to the value imposed by 1 to 20 amps per volt.

Recommended for electrode: Cellulosic, Aluminum

P=C Constant power

The increase in arc length causes a reduction in the welding current (and vice versa) according to the law: $V \cdot I = K$

Recommended for electrode: Cellulosic, Aluminum

312 Arc detachment voltage



Allows you to set the voltage value at which the electric arc switch-off is forced.

Allows to manage better the various operating conditions that are created.

In the spot welding phase, for example, a low arc detachment voltage reduces re-striking of the arc when moving the electrode away from the piece, reducing spatter, burning and oxidation of the piece.



Never set an arc detachment voltage higher than the no-load voltage of the power source.

Basic electrode

Minimum	Maximum	Default
0/off	Vmax	57.0 V

Cellulosic electrode

Minimum	Maximum	Default
0/off	Vmax	70.0 V

399 Welding speed



Lets you set welding speed.

Default cm/min: reference speed for manual welding.

Syn: Sinergic value.

Minimum	Maximum	Default
2 cm/min	200 cm/min	15 cm/min

500 Machine setting



Allows the selection of the required graphic interface.

Allows access to the higher set-up levels.

Refer to section "Interface personalisation (Set up 500)"

Value	Selected level
USER	User
SERV	Service
vaBW	vaBW

Value	User interface
XE	Easy Mode
XA	Advanced Mode
XP	Professional Mode

551 Lock/unlock



Allows the locking of the panel controls and the insertion of a protection code.

Refer to section "Lock/unlock (Set up 551)".

552 Buzzer tone



Permits adjustment of the buzzer tone.

Minimum	Maximum	Default
0/off	10	10

601 Regulation step



Allows the regulation of a parameter with a step that can be personalised by the operator.

Minimum	Maximum	Default
1	I _{max}	1

602 External parameter 2



Allows the management of the external parameter 2 (minimum value, maximum value, default value, parameter selected).

705 **Circuit resistance calibration**
 Allows the calibration of the system.
 Refer to section "Circuit resistance calibration (set up 705)".



751 **Current reading**
 Allow the real value of the welding current to be displayed.



752 **Voltage reading**
 Allows the real value of the welding voltage to be displayed.



768 **HI heat input measurement**
 Allows reading of the value of the measurement of the heat input in welding.



5.1.2 List of set up parameters (TIG)

0 **Save and Exit**
 Allows you to save the changes and exit the set up.



1 **Reset**
 Allows you to reset all the parameters to the default values.



2 **Pre-gas**
 Allows you to set and adjust the gas flow prior to striking of the arc.
 Permits filling of the torch with gas and preparation of the environment for welding.



Minimum	Maximum	Default
0/off	99.9 s	0.1 s

3 **Initial current**
 Allows regulation of the weld starting current.
 Allows a hotter or cooler welding pool to be obtained immediately after the arc striking.



Minimum	Maximum	Default	Minimum	Maximum	Default
1%	200%	50%	3 A	I _{max}	-

5 **Initial current time**
 Allows setting of the time for which the initial current is maintained.



Minimum	Maximum	Default
0/off	99.9 s	0/off

6 **Slope-up**
 Allows you to set a gradual passage between the initial current and the welding current.



Minimum	Maximum	Default
0/off	99.9 s	0/off

7 **Welding current**
 Allows the regulation of the welding current.



Minimum	Maximum	Default
3 A	I _{max}	100 A

8

Bilevel current



Permits adjustment of the secondary current in the bilevel welding mode.

On first pressing the torch button, the pre-gas starts, the arc strikes and the initial current will be used when welding. At the first release there is the ramp to go up to the current "I1".

If the welder now presses and releases the button quickly, "I2" can be used.

By pressing and releasing it quickly again, "I1" is used again, and so on.

If you press the button for a longer time, the lowering ramp for the current starts, thus reaching the final current.

By releasing the button again, the arc goes out and the gas continues to flow for the post-gas stage.

Minimum	Maximum	Default
3 A	I _{max}	-

Minimum	Maximum	Default
1%	500%	off

10

Basic current



Permits adjustment of the base current in pulsed and fast pulse modes.

Minimum	Maximum	Default
3 A	I _{sald}	-

Minimum	Maximum	Default
1%	100%	50%

12

Pulsed frequency



Allows activation of the pulse mode.

Allows better results to be obtained in the welding of thin materials and better aesthetic quality of the bead.

Minimum	Maximum	Default
0.1 Hz	25 Hz	5 Hz

13

Pulsed duty cycle



Allows regulation of the duty cycle in pulse welding.

Allows the peak current to be maintained for a shorter or longer time.

Minimum	Maximum	Default
1 %	99 %	50 %

14

Fast Pulse frequency



Allows activation of the pulse mode.

Allows focusing action and better stability of the electric arc to be obtained.

Minimum	Maximum	Default
0.02 KHz	2.5 KHz	0.25 KHz

15

Pulsed slopes



Allows setting of a slope time during the pulse operation.

Allows a smooth step to be obtained between the peak current and the basic current, having a more or less soft welding arc.

Minimum	Maximum	Default
0/off	100 %	0/off

16

Slope-down



Allows you to set a gradual passage between the welding current and the final current.

Minimum	Maximum	Default
0/off	99.9 s	0/off

17

Final current



Permits adjustment of the final current.

Minimum	Maximum	Default
3 A	I _{max}	10 A

Minimum	Maximum	Default
1%	200%	50%

19

Final current time



Makes it possible to set the time for which the final current is maintained.

Minimum	Maximum	Default
0/off	99.9 s	0/off

20

Post-gas



Permits setting and adjustment of the gas flow at the end of welding.

Minimum	Maximum	Default
0/off	99.9 s	syn

203 Tig start (HF)

Allows selection of the required arc striking modes.

Value	Default	Callback function
on	X	HF START
off	-	LIFT START

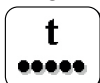
204 Spot welding

Allows you to enable the "spot welding" process and establish the welding time.

Allows the timing of the welding process.

Minimum	Maximum	Default
0/off	99.9 s	0/off

205 Restart

Allows the activation of the restart function.

Allows the immediate extinguishing of the arc during the down slope or the restarting of the welding cycle.

Value	Default	Callback function
0/off	-	off
1/on	X	on
2/of1	-	off

206 Easy joining

Allows striking of the arc in pulsed current and timing of the function before the automatic reinstatement of the pre-set welding conditions.

Allows greater speed and accuracy during tack welding operations on the parts

Minimum	Maximum	Default
0.1 s	25.0 s	0/off

208 Microtime spot welding

Allows you to enable the "microtime spot welding" process.

Allows the timing of the welding process.

Minimum	Maximum	Default
0.01 s	1.00 s	0/off

399 Welding speed

Lets you set welding speed.

Default cm/min: reference speed for manual welding.

Syn: Sinergic value.

Minimum	Maximum	Default
2 cm/min	200 cm/min	10 cm/min

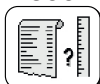
500 Machine setting

Allows the selection of the required graphic interface.

Allows access to the higher set-up levels.

Refer to section "Interface personalisation (Set up 500)"

Value	Selected level	Value	User interface
USER	User	XE	Easy Mode
SERV	Service	XA	Advanced Mode
vaBW	vaBW	XP	Professional Mode

551 Lock/unlock

Allows the locking of the panel controls and the insertion of a protection code.

Refer to section "Lock/unlock (Set up 551)".

552 Buzzer tone

Permits adjustment of the buzzer tone.

Minimum	Maximum	Default
0/off	10	10

601 Regulation step



Allows the regulation of a parameter with a step that can be personalised by the operator.

Minimum	Maximum	Default
1	Imax	1

602 External parameter CH1, CH2, CH3, CH4



Allows the management of the external parameter 1, 2, 3, 4 (minimum value, maximum value, default value, parameter selected).

Refer to section "External controls management (Set up 602)".

606 U/D torch



Allows the management of the external parameter (U/D).

Value	Default	Callback function
0/off	-	off
1/11	X	Current
	-	Program retrieval

612 Setting Torch DgTig



It allows the management of the channels of the digital torch.

Value	Default	Callback function
0/off	-	off
1/11	-	Current
2/	-	Program retrieval
3/CH3	-	CH3
4/CH4	-	CH4
5/STD	X	STD

705 Circuit resistance calibration



Allows the calibration of the system.

Refer to section "Circuit resistance calibration (set up 705)".

751 Current reading



Allow the real value of the welding current to be displayed.

752 Voltage reading



Allows the real value of the welding voltage to be displayed.

758 Robot movement speed



Allows the arm movement speed of a robot or an automation device to be displayed.

764 Coolant flow reading



Allow the value of the coolant flow reading.

765 Coolant temperature reading



Allow the real value of coolant temperature reading to be displayed.

768 HI heat input measurement



Allows reading of the value of the measurement of the heat input in welding.

801 Guard limits



Allows the setting of the warning limits and of the guard limits.
 Allows the welding process to be controlled by setting warning limits and guard limits for the main measurable parameters.
 Allows the accurate control of the various welding phases.

5.2 Specific procedures parameters

5.2.1 7 segment display personalisation

It allows you to constantly view the value of a parameter on the 7-segment display.

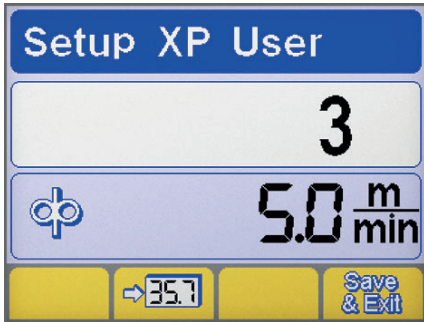

- ▶ Enter set-up by pressing the encoder button for at least 5 seconds.
- ▶ Select the required parameter by rotating the encoder.
- ▶ Store the selected parameter in the 7 segment display by pressing button **35.7**.
- ▶ Save and exit the current screen by pressing button **Save & Exit**.

5.2.2 Interface personalisation (Set up 500)

Allows the parameters to be customized on the main menu.

500 Machine setting



Allows the selection of the required graphic interface.

Value	User interface
XE	Easy Mode
XA	Advanced Mode
XP	Professional Mode

XE MODE

MMA

Welding parameters **I₁**

TIG

Welding parameters **I₁** **I₂**

Functions

XA MODE

MMA

Welding parameters **I₁**

Functions **Std** **ClS** **CrNi** **Al** **Cast Iron**

TIG

Welding parameters **I₁** **I₂**

Functions

XP MODE

EN

MMA	
Welding parameters	
Functions	
TIG	
Welding parameters	
Functions	

5.2.3 Lock/unlock (Set up 551)

Allows the locking of the panel controls and the insertion of a protection code.

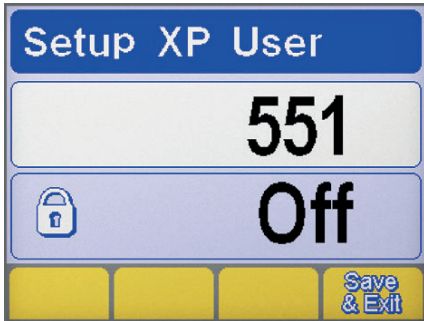

Parameter selection

- ▶ Enter set-up by pressing the encoder button for at least 5 seconds.
- ▶ Select the required parameter (551).
- ▶ Activate the regulation of the selected parameter by pressing the encoder button.

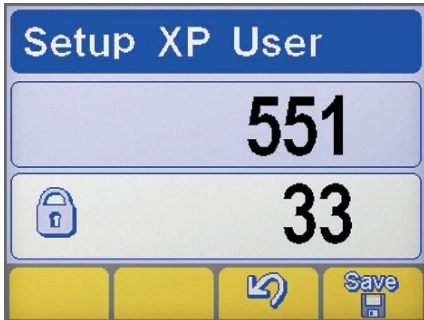

Setting the password

- ▶ Set a numerical code (password) by rotating the encoder.
- ▶ Confirm the operation by pressing the encoder key.
- ▶ Cancel the operation by pressing button .
- ▶ To save the change, press the button: .

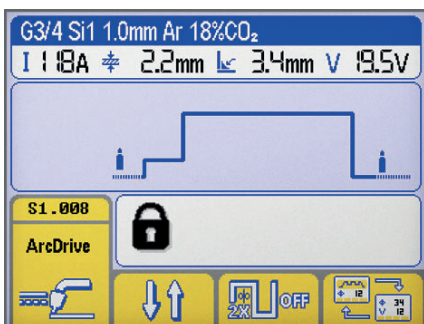

Control panel functions



The carrying out of any operation on a locked control panel causes a special screen to appear.

- ▶ Access the panel functionalities temporarily (5 minutes) by rotating the encoder and entering the correct password.
- ▶ Confirm the operation by pressing the encoder key.
- ▶ Unlock the control panel definitively by entering set-up (follow the instructions given above) and bring back parameter 551 to "off".
- ▶ Confirm the operation by pressing the encoder key.
- ▶ To save the change, press the button: .

5.2.4 External controls management (Set up 602)

Allows the management of the external parameter 2 (minimum value, maximum value, default value, parameter selected).

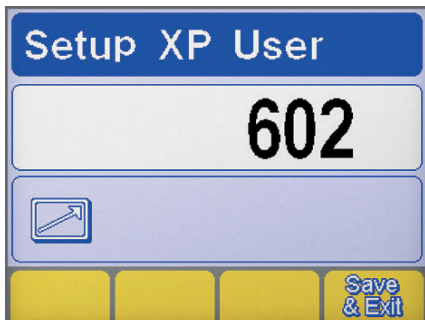

Parameter selection

- ▶ Enter set-up by pressing the encoder button for at least 5 seconds.
- ▶ Select the required parameter (602).
- ▶ Enter the "External controls management" screen by pressing the encoder button.

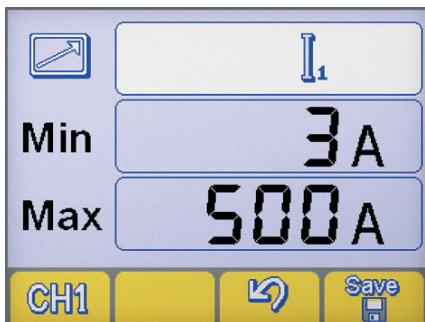

External controls management

- ▶ Select the required RC remote control output (CH1, CH2, CH3, CH4) by pressing button **CH1**.
- ▶ Select the required parameter (Min-Max-parameter) by pressing the encoder button.
- ▶ Adjust the required parameter (Min-Max-parameter) by rotating the encoder.
- ▶ To save the change, press the button: **Save**.
- ▶ Cancel the operation by pressing button **Cancel**.

5.2.5 Circuit resistance calibration (set up 705)

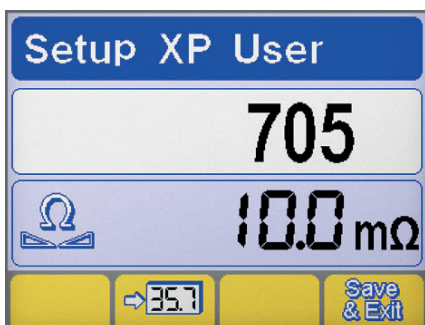

Parameter selection

- ▶ Enter set-up by pressing the encoder button for at least 5 seconds.
- ▶ Select the required parameter (705).
- ▶ Activate the regulation of the selected parameter by pressing the encoder button.

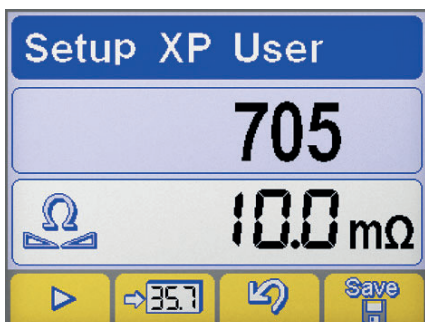

Calibration

- ▶ Place the tungsten electrode in electrical contact with the work piece. (TIG)
- ▶ Place the electrode holder torch and the piece to be welded into contact. (MMA)
- ▶ Press the **▶** button (or the torch trigger) to start the procedure.
- ▶ Maintain contact for at least one second.
- ▶ The value shown on the display will update after calibration.
- ▶ Confirm the operation by pressing button **Save**.
- ▶ Cancel the operation by pressing button **Cancel**.
- ▶ To save the change and exit the set up, press the key: **Save & Exit**.

5.2.6 Guard limits (Set up 801)

Allows the setting of the warning limits and of the guard limits.

Allows the welding process to be controlled by setting warning limits and guard limits for the main measurable parameters.

Allows the accurate control of the various welding phases.

Refer to section "Guard limits (Set up 801)".

Warning limits		MIN	MAX	Guard limits		MIN	MAX
	Welding current				Welding voltage		
	Gas flow reading				Robot movement speed		
	Current reading (motor 1)				Current reading (motor 2)		



Coolant flow reading



Wire speed reading



Coolant temperature reading

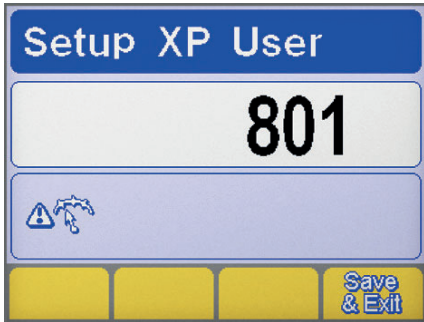

Parameter selection

- ▶ Enter set-up by pressing the encoder button for at least 5 seconds.
- ▶ Select the required parameter (801).
- ▶ Enter the "Guard limits" screen by pressing the encoder button.

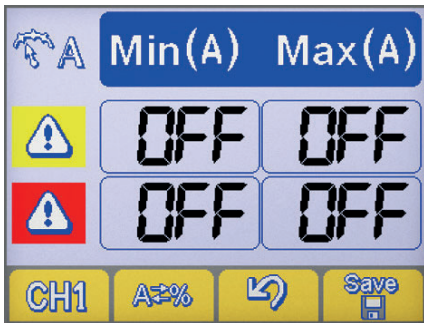

Parameter selection

- ▶ Select the required parameter by pressing button **CH1**.
- ▶ Select the method of setting the guard limits by pressing button **A=%**.



Mode selection



Absolute value



Percentage value

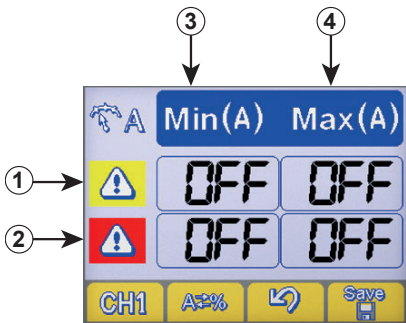

Guard limits setting

- ① Warning limits line
- ② Alarm limits line
- ③ Minimum levels column
- ④ Maximum levels column

- ▶ Select the required box by pressing the encoder key (the selected box is displayed with reverse contrast).
- ▶ Adjust the level of the selected limit by rotating the encoder.
- ▶ To save the change, press the button: **Save**.



- ▶ Passing one of the warning limits causes a visual signal to appear on the control panel.
- ▶ Passing one of the alarm limits causes a visual signal to appear on the control panel and the immediate blockage of the welding operations.
- ▶ It is possible to set start and end of welding filters to prevent error signals during the striking and extinction of the arc (consult the "Set up" section - Parameters 802-803-804).

6. MAINTENANCE



Routine maintenance must be carried out on the system according to the manufacturer's instructions. When the equipment is working, all the access and operating doors and covers must be closed and locked. The system must not be modified in any way. Prevent conductive dust from accumulating near the louvers and over them.



Any maintenance operation must be performed by qualified personnel only. The repair or replacement of any parts in the system by unauthorised personnel will invalidate the product warranty. The repair or replacement of any parts in the system must be carried out only by qualified personnel.



Disconnect the power supply before every operation!

6.1 Carry out the following periodic checks on the power source

6.1.1 System



Clean the power source inside by means of low-pressure compressed air and soft bristle brushes. Check the electric connections and all the connection cables.

6.1.2 For the maintenance or replacement of torch components, electrode holders and/or earth cables:



Check the temperature of the component and make sure that they are not overheated.



Always use gloves in compliance with the safety standards.



Use suitable wrenches and tools.

6.2 Responsibility



Failure to carry out the above maintenance will invalidate all warranties and exempt the manufacturer from any liability. The manufacturer disclaims any responsibility if the user fails to follow these instructions. For any doubts and/or problems do not hesitate to contact your nearest customer service centre.

7. ALARM CODES



ALARM

Activation of an alarm or the passing of any critical limit causes a visual signal to appear on the control panel and the immediate shut-down of welding operations.































CAUTION

Exceeding a guard limit causes a visual signal on the control panel but allows the welding operations to continue.

All the alarms and all the guard limits relating to the system are listed below.

E01	Overtemperature		E02	Overtemperature	
E03	Overtemperature		E05	Overcurrent	
E06	Power module overcurrent (Boost)		E07	Wire feeder motor power supply fault	
E08	Blocked motor		E10	Power module overcurrent (Inverter)	

 E11	System configuration error		 E13	Communication error (FP)	
 E14.xx	Invalid program the error sub-code indicates the number of the deleted job		 E15	Invalid program	
 E16	Communication error (RI) (Automation and robotics)		 E18.xx	Invalid program the error sub-code indicates the number of the deleted job	
 E19	System configuration error		 E20	Memory fault	
 E21	Data loss		 E22	Communication error (DSP)	
 E27	Memory fault (RTC)		 E29	Incompatible measurements	
 E30	Communication error (H.F.)		 E32	Data loss	
 E33	System configuration error (LCD 3.5")		 E38	Undervoltage	
 E39	System power supply fault		 E40	System power supply fault	
 E41	Overvoltage		 E42	Undervoltage	
 E43	Coolant shortage		 E49	Emergency switch (Automation and robotics)	
 E51	Unsupported settings (Automation and robotics)		 E52	Anti-collision (Automation and robotics)	
 E53	External flow switch fault (Automation and robotics)		 E54	Current level exceeded (Lower limit)	
 E55	Current level exceeded (Upper limit)		 E56	Voltage level exceeded (Lower limit)	
 E57	Voltage level exceeded (Upper limit)		 E58	Gas flow level exceeded (Lower limit)	
 E59	Gas flow level exceeded (Upper limit)		 E62	Current level exceeded (Lower limit)	
 E63	Current level exceeded (Upper limit)		 E64	Voltage level exceeded (Lower limit)	

 E65	Voltage level exceeded (Upper limit)		 E66	Gas flow level exceeded (Lower limit)	
 E67	Gas flow level exceeded (Upper limit)		 E71	Coolant overtemperature	
 E72	Push-pull motor overcurrent		 E73	Wire speed limit exceeded (speed meter)	
 E75	Motor 2 current level exceeded		 E76	Liquid coolant flow level exceeded	
 E77	Coolant temperature level exceeded		 E78	Active maintenance (Automation and robotics)	
 E81	Overcurrent (WU pump)		 E82	Communication error (WU)	
 E83	Pump blocked		 E99	General alarm	

8. TROUBLESHOOTING

The system fails to come on (green LED off)

Cause

- » No mains voltage at the socket.
- » Faulty plug or cable.
- » Line fuse blown.
- » Faulty on/off switch.
- » Faulty electronics.

Solution

- » Check and repair the electrical system as needed.
- » Use qualified personnel only.
- » Replace the faulty component.
- » Contact the nearest service centre to have the system repaired.
- » Replace the faulty component.
- » Replace the faulty component.
- » Contact the nearest service centre to have the system repaired.
- » Contact the nearest service centre to have the system repaired.

No output power (the system does not weld)

Cause

- » Faulty torch trigger button.
- » The system has overheated (temperature alarm - yellow LED on).
- » Incorrect earth connection.
- » Mains voltage out of range (yellow LED on).
- » Faulty contactor.
- » Faulty electronics.

Solution

- » Replace the faulty component.
- » Contact the nearest service centre to have the system repaired.
- » Wait for the system to cool down without switching it off.
- » Earth the system correctly.
- » Read the paragraph "Installation".
- » Bring the mains voltage within the power source admissible range.
- » Connect the system correctly.
- » Read the paragraph "Connections".
- » Replace the faulty component.
- » Contact the nearest service centre to have the system repaired.
- » Contact the nearest service centre to have the system repaired.

Incorrect output power

Cause

- » Incorrect selection in the welding process or faulty selector switch.

Solution

- » Select the welding process correctly.

- | | |
|---|--|
| <ul style="list-style-type: none"> » System parameters or functions set incorrectly. | <ul style="list-style-type: none"> » Reset the system and the welding parameters. |
| <ul style="list-style-type: none"> » Faulty potentiometer/encoder for the adjustment of the welding current. | <ul style="list-style-type: none"> » Replace the faulty component. » Contact the nearest service centre to have the system repaired. |
| <ul style="list-style-type: none"> » Mains voltage out of range. | <ul style="list-style-type: none"> » Connect the system correctly. » Read the paragraph "Connections". |
| <ul style="list-style-type: none"> » Input mains phase missing. | <ul style="list-style-type: none"> » Connect the system correctly. » Read the paragraph "Connections". |
| <ul style="list-style-type: none"> » Faulty electronics. | <ul style="list-style-type: none"> » Contact the nearest service centre to have the system repaired. |

Arc instability

Cause

- » Insufficient shielding gas.
- » Humidity in the welding gas.
- » Incorrect welding parameters.

Solution

- » Adjust the air flow.
- » Check that the diffuser and the gas nozzle of the torch are in good condition.
- » Always use quality materials and products.
- » Ensure the gas supply system is always in perfect condition.
- » Check the welding system carefully.
- » Contact the nearest service centre to have the system repaired.

Excessive spatter

Cause

- » Incorrect arc length.
- » Incorrect welding parameters.
- » Insufficient shielding gas.
- » Incorrect arc regulation.
- » Incorrect welding mode.

Solution

- » Decrease the distance between the electrode and the piece.
- » Decrease the welding voltage.
- » Decrease the welding current.
- » Adjust the air flow.
- » Check that the diffuser and the gas nozzle of the torch are in good condition.
- » Increase the equivalent circuit inductive value setting.
- » Decrease the torch angle.

Insufficient penetration

Cause

- » Incorrect welding mode.
- » Incorrect welding parameters.
- » Incorrect electrode.
- » Incorrect edge preparation.
- » Incorrect earth connection.
- » Pieces to be welded too big.

Solution

- » Decrease the travel speed while welding.
- » Increase the welding current.
- » Use a smaller diameter electrode.
- » Increase the chamfering.
- » Earth the system correctly.
- » Read the paragraph "Installation".
- » Increase the welding current.

Slag inclusions

Cause

- » Poor cleanliness.
- » Electrode diameter too big.
- » Incorrect edge preparation.
- » Incorrect welding mode.

Solution

- » Clean the pieces accurately before welding.
- » Use a smaller diameter electrode.
- » Increase the chamfering.
- » Decrease the distance between the electrode and the piece.
- » Move regularly during all the welding operations.

Tungsten inclusions

Cause

- » Incorrect welding parameters.
- » Incorrect electrode.

Solution

- » Decrease the welding current.
- » Use a bigger diameter electrode.
- » Always use quality materials and products.
- » Sharpen the electrode carefully.

» Incorrect welding mode.

» Avoid contact between the electrode and the weld pool.

Blowholes
Cause

» Insufficient shielding gas.

Solution

- » Adjust the air flow.
- » Check that the diffuser and the gas nozzle of the torch are in good condition.

Sticking
Cause

» Incorrect arc length.

» Incorrect welding parameters.

» Incorrect welding mode.

» Pieces to be welded too big.

» Incorrect arc regulation.

Solution

- » Increase the distance between the electrode and the piece.
- » Increase the welding voltage.
- » Increase the welding current.
- » Increase the welding voltage.
- » Angle the torch more.
- » Increase the welding current.
- » Increase the welding voltage.
- » Increase the equivalent circuit inductive value setting.

Undercuts
Cause

» Incorrect welding parameters.

» Incorrect arc length.

» Incorrect welding mode.

» Insufficient shielding gas.

Solution

- » Decrease the welding current.
- » Use a smaller diameter electrode.
- » Decrease the distance between the electrode and the piece.
- » Decrease the welding voltage.
- » Decrease the side oscillation speed while filling.
- » Decrease the travel speed while welding.
- » Use gases suitable for the materials to be welded.

Oxidations
Cause

» Insufficient shielding gas.

Solution

- » Adjust the air flow.
- » Check that the diffuser and the gas nozzle of the torch are in good condition.

Porosity
Cause

» Grease, varnish, rust or dirt on the workpieces to be welded.

» Grease, varnish, rust or dirt on the filler material.

» Humidity in the filler metal.

» Incorrect arc length.

» Humidity in the welding gas.

» Insufficient shielding gas.

» The weld pool solidifies too quickly.

Solution

- » Clean the pieces accurately before welding.
- » Always use quality materials and products.
- » Keep the filler metal always in perfect condition.
- » Always use quality materials and products.
- » Keep the filler metal always in perfect condition.
- » Decrease the distance between the electrode and the piece.
- » Decrease the welding voltage.
- » Always use quality materials and products.
- » Ensure the gas supply system is always in perfect condition.
- » Adjust the air flow.
- » Check that the diffuser and the gas nozzle of the torch are in good condition.
- » Decrease the travel speed while welding.
- » Pre-heat the workpieces to be welded.
- » Increase the welding current.

Hot cracks

Cause

- » Incorrect welding parameters.
- » Grease, varnish, rust or dirt on the workpieces to be welded.
- » Grease, varnish, rust or dirt on the filler material.
- » Incorrect welding mode.
- » Pieces to be welded have different characteristics.

Solution

- » Decrease the welding current.
- » Use a smaller diameter electrode.
- » Clean the pieces accurately before welding.
- » Always use quality materials and products.
- » Keep the filler metal always in perfect condition.
- » Carry out the correct sequence of operations for the type of joint to be welded.
- » Carry out buttering before welding.

Cold cracks

Cause

- » Humidity in the filler metal.
- » Particular geometry of the joint to be welded.

Solution

- » Always use quality materials and products.
- » Keep the filler metal always in perfect condition.
- » Pre-heat the workpieces to be welded.
- » Carry out post-heating.
- » Carry out the correct sequence of operations for the type of joint to be welded.

9. OPERATING INSTRUCTIONS

9.1 Manual Metal Arc welding (MMA)

Preparing the edges

To obtain good welding joints it is advisable to work on clean parts, free from oxidations, rust or other contaminating agents.

Choosing the electrode

The diameter of the electrode to be used depends on the thickness of the material, the position, the type of joint and the type of preparation of the piece to be welded.

Electrodes of large diameter obviously require very high currents with consequent high heat supply during the welding.

Type of coating	Property	Use
Rutile	Easy to use	All positions
Acid	High melting speed	Flat
Basic	High quality of joint	All positions

Choosing the welding current

The range of welding current related to the type of electrode used is specified by the manufacturer usually on the electrode packaging.

Striking and maintaining the arc

The electric arc is produced by scratching the electrode tip on the workpiece connected to the earth cable and, once the arc has been struck, by rapidly withdrawing the electrode to the normal welding distance.

Generally, to improve the arc striking behaviour a higher initial current is given in order to heat suddenly the tip of the electrode and so aid the arc establishing (Hot Start).

Once the arc has been struck, the central part of the electrode starts melting forming tiny globules which are transferred into the molten weld pool on the workpiece surface through the arc stream.

The external coating of the electrode is being consumed and this supplies the shielding gas for the weld pool, ensuring the good quality of the weld.

To stop droplets of molten material short-circuiting the electrode to the weld pool and extinguishing the arc if the electrode accidentally approaches the pool too closely, it is useful to increase welding current (Arc Force) temporarily in order to break a short circuit.

If the electrode sticks to the workpiece, the short circuit current should be reduced to the minimum (antisticking).

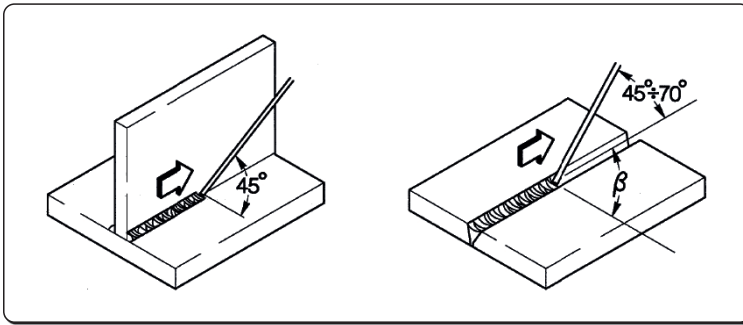

Carrying out the welding

Electrode angle depends on the number of runs. The electrode should normally be moved in a weaving motion with pauses at the sides of the bead to avoid an excessive accumulation of filler material at the centre.

Removing the slag

Welding using covered electrodes requires the removal of the slag after each run. The slag is removed by a small hammer or is brushed away if friable.

9.2 TIG welding (continuous arc)

Description

The TIG (Tungsten Inert Gas) welding process is based on the presence of an electric arc struck between a non-consumable electrode (pure or alloyed tungsten with an approximate melting temperature of 3370 °C) and the workpiece. An inert gas (argon) atmosphere protects the weld pool.

To avoid dangerous inclusions of tungsten in the joint, the electrode must never come in contact with the workpiece; for this reason the welding power source is usually equipped with an arc striking device that generates a high frequency, high voltage discharge between the tip of the electrode and the workpiece. Thus, thanks to the electric spark, ionizing the gas atmosphere, the welding arc is struck without any contact between electrode and workpiece.

Another type of start is also possible, with reduced tungsten inclusions: this is the lift start. Lift starts do not require high frequency, but only an initial low current short circuit between the electrode and the workpiece. When the electrode is lifted, the arc is established and the current increases to the set welding value.

To improve the quality of the filling at the end of the welding bead it is important to control carefully the down slope of the current and it is necessary that the gas still flows in the welding pool for some seconds after the arc is extinguished.

Under many operating conditions, it is useful to be able to use two preset welding currents and to be able to switch easily from one to the other (BILEVEL).

Welding polarity

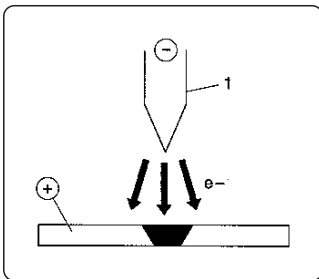

D.C.S.P. (Direct Current Straight Polarity)

This is the most used polarity and ensures limited wear of the electrode (1), since 70% of the heat is concentrated in the anode (piece). Narrow and deep weld pools are obtained, with high travel speeds and low heat supply.

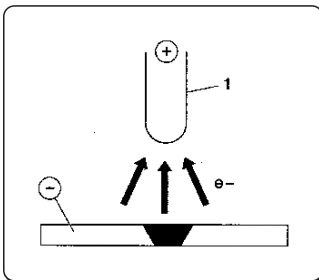

D.C.R.P. (Direct Current Reverse Polarity)

The reverse polarity is used for welding alloys covered with a layer of refractory oxide with higher melting temperature compared with metals. High currents cannot be used, since they would cause excessive wear on the electrode.

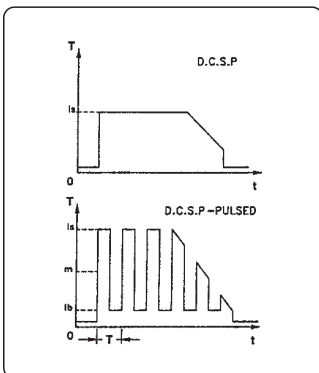

D.C.S.P.-Pulsed (Direct Current Straight Polarity Pulsed)

The use of pulsed direct current allows better control, in particular operating conditions, of the welding pool width and depth.

The welding pool is formed by the peak pulses (Ip), while the base current (Ib) keeps the arc ignited. This makes it easier to weld thinner metal with less deformation, a better form factor and consequently a reduced risk of hot cracks and gas inclusion.

Increasing the frequency (MF) the arc becomes narrower, more concentrated, more stable and the quality of welding on thin sheets is further increased.

Characteristics of TIG welds

The TIG procedure is very effective for welding both carbon and alloyed steel, for first runs on pipes and for welding where good appearance is important.

Straight polarity is required (D.C.S.P.).

Preparing the edges

Careful cleaning and preparation of the edges are required.

Choosing and preparing the electrode

You are advised to use thorium tungsten electrodes (2% thorium-red coloured) or alternatively cerium or lanthanum electrodes with the following diameters:

Current range			Electrode	
(DC-)	(DC+)	(AC)	∅	α
3-20 A	-	3-20 A	0,5 mm	30°
15-80 A	-	20-30 A	1,0 mm	30-60°
70-150 A	10-20 A	30-80 A	1,6 mm	60-90°
150-250 A	15-30 A	60-130 A	2,4 mm	90-120°
250-400 A	25-40 A	100-180 A	3,2 mm	120-150°
400-500 A	40-55 A	160-240 A	4,0 mm	150-180°
500-750 A	55-80 A	190-300 A	4,8 mm	150-180°
750-1100 A	80-125 A	325-450 A	6,4 mm	150-180°

The electrode must be sharpened as shown in the figure.

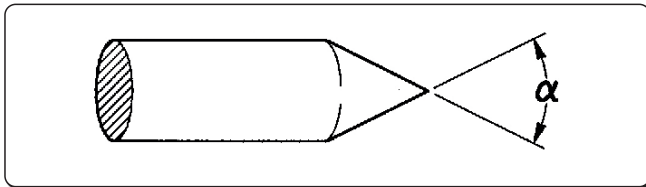

Filler metal

The filler rods must have mechanical characteristics comparable to those of the parent metal.

Do not use strips obtained from the parent metal, since they may contain working impurities that can negatively affect the quality of the welds.

Shielding gas

Typically, pure argon (99.99%) is used.

Current range			Gas	
(DC-)	(DC+)	(AC)	Nozzle	Flow
3-20 A	-	3-20 A	n° 4	5-6 l/min
15-80 A	-	20-30 A	n° 5	6-8 l/min
70-150 A	10-20 A	30-80 A	n° 6	7-10 l/min
150-250 A	15-30 A	60-130 A	n° 7	8-12 l/min
250-400 A	25-40 A	100-180 A	n° 8	10-14 l/min
400-500 A	40-55 A	160-240 A	n° 8	12-16 l/min
500-750 A	55-80 A	190-300 A	n° 10	15-20 l/min
750-1100 A	80-125 A	325-450 A	n° 12	20-25 l/min

10. TECHNICAL SPECIFICATIONS

Electrical characteristics			U.M.
Power supply voltage U1 (50/60 Hz)	3x230 (±15%)	3x400 (±15%)	Vac
Zmax (@PCC) *	53	53	mΩ
Slow blow line fuse	25	16	A
Communication bus	DIGITAL	DIGITAL	
Maximum input power	10.5	10.5	kVA
Maximum input power	10.1	10.1	kW
Power consumption in standby	51	51	W
Power factor (PF)	0.96	0.96	
Efficiency (μ)	83	83	%
Cos φ	0.99	0.99	
Max. input current I1max	30.8	15.3	A
Effective current I1eff	18	9	A
Adjustment range	3-270	3-270	A
Open circuit voltage	80	80	Vdc
Peak voltage Up	10.1	10.1	kV

* This equipment complies with EN / IEC 61000-3-11.

* This equipment conforms to the requirements of EN / IEC 61000-3-12 provided maximum permissible mains impedance at the point of interface with the public grid (point of common coupling, PCC) is below or equal to the declared Zmax value. If it is connected to a public low voltage system, it is the responsibility of the installer or user of the equipment to ensure, by consultation with the distribution network operator if necessary, that the equipment may be connected.

Duty factor	3x230V	3x400V	U.M.
Duty factor (40°C)			
(X=35%)	270	270	A
(X=60%)	230	230	A
(X=100%)	180	180	A
Duty factor (25°C)			
(X=80%)	270	270	A
(X=100%)	240	240	A

Physical characteristics			U.M.
IP Protection rating	IP23S		
Insulation class	H		
Dimensions (lxdxh)	500x190x400		mm
Weight	18.8		Kg
Power supply cable section	4x4		mm ²
Length of power supply cable	5		m
Manufacturing Standards	EN IEC 60974-1/A1:2019 EN IEC 60974-3:2019 EN 60974-10/A1:2015		

11. RATING PLATE

VOESTALPINE BÖHLER WELDING SELCO S.R.L. Via Palladio, 19 - ONARA (PADOVA) - ITALY					
URANOS NX 2700 TLH			N°		
EN IEC 60974-1/A1:2019 60974-10/A1:2015 Class A		60974-3:2019			
	Up 10.1 kV				
	3A/10.0V - 270A (270A)/20.8V (20.8V)				
	X (40°C)	35%	60%	100%	
	U ₀	I ₂	270A (270A)	230A (230A)	180A (180A)
	80V	U ₂	20.8V (20.8V)	19.2V (19.2V)	17.2V (17.2V)
	3A/20.0V - 270A (270A)/30.8V (30.8V)				
	X (40°C)				
	35% 60% 100%				
	U ₀	I ₂	270A (270A)	230A (230A)	180A (180A)
	80V	U ₂	30.8V (30.8V)	29.2V (29.2V)	27.2V (27.2V)
	U ₁ 400V(230V)	I _{1max} 15.3A(30.8A)	I _{1eff} 9A(18A)		
IP 23 S					
MADE IN ITALY					

12. MEANING RATING PLATE

1		2			
3			4		
5		6			
7	9	23			
		11			
8	10	12	15	16	17
		13	15A	16A	17A
		14	15B	16B	17B
7	9	11			
		12	15	16	17
8	10	13	15A	16A	17A
		14	15B	16B	17B
18	19	20	21		
22					
MADE IN ITALY					

- 1 Trademark
- 2 Name and address of manufacturer
- 3 Machine model
- 4 Serial no.
X**XX**XXXXXXXXXX Year of manufacture
- 5 Welding unit symbol
- 6 Reference to construction standards
- 7 Welding process symbol
- 8 Symbol for equipments suitable for operation in environments with increased electrical shock risk
- 9 Welding current symbol
- 10 Rated no load voltage
- 11 Max-Min current range and corresponding conventional load voltage
- 12 Intermittent cycle symbol
- 13 Rated welding current symbol
- 14 Rated welding voltage symbol
- 15 Intermittent cycle values
- 16 Intermittent cycle values
- 17 Intermittent cycle values
- 15A Rated welding current values
- 16A Rated welding current values
- 17A Rated welding current values
- 15B Conventional load voltage values
- 16B Conventional load voltage values
- 17B Conventional load voltage values
- 18 Power supply symbol
- 19 Rated power supply voltage
- 20 Maximum rated power supply current
- 21 Maximum effective power supply current
- 22 Protection rating
- 23 Rated peak voltage

CE EU declaration of conformity
 EAC EAC declaration of conformity
 UKCA UKCA declaration of conformity

DICHIARAZIONE DI CONFORMITÀ EU

Il costruttore

voestalpine Böhler Welding Selco S.r.l. - Via Palladio, 19 - 35019 Onara di Tombolo (PD) - ITALY
Tel. +39 049 9413/111 - Fax +39 049 9413/311 - www.voestalpine.com/welding

dichiara sotto la propria esclusiva responsabilità che il seguente prodotto:

URANOS NX 2700 TLH	55.07.042
	55.07.043

è conforme alle direttive EU:

2014/35/EU LOW VOLTAGE DIRECTIVE

2014/30/EU EMC DIRECTIVE

2011/65/EU RoHS DIRECTIVE

2019/1784/EU EcoDesign

2009/125/EU EcoDesign

e che sono state applicate le norme:

EN IEC 60974-1/A1:2019	WELDING POWER SOURCE
EN IEC 60974-3:2019	ARC STRIKING AND STABILIZING DEVICES
EN 60974-10/A1:2015	ELECTROMAGNETIC COMPATIBILITY REQUIREMENTS

La documentazione attestante la conformità alle direttive sarà tenuta a disposizione per ispezioni presso il sopraccitato costruttore.

Ogni intervento o modifica non autorizzati dalla voestalpine Böhler Welding Selco S.r.l. faranno decadere la validità di questa dichiarazione.

Onara di Tombolo, 01/07/2024

voestalpine Böhler Welding Selco s.r.l.



Mirco Frasson **Ivo Bonello**

Managing Directors

INDICE

1. AVVERTENZE.....	44
1.1 Ambiente di utilizzo	44
1.2 Protezione personale e di terzi	44
1.3 Protezione da fumi e gas	45
1.4 Prevenzione incendio/scoppio.....	46
1.5 Prevenzione nell'uso delle bombole di gas	46
1.6 Protezione da shock elettrico.....	46
1.7 Campi elettromagnetici ed interferenze.....	46
1.8 Grado di protezione IP.....	48
1.9 Smaltimento.....	48
2. INSTALLAZIONE	48
2.1 Modalità di sollevamento, trasporto e scarico.....	48
2.2 Posizionamento dell'impianto	48
2.3 Allacciamento	48
2.4 Messa in servizio	49
3. PRESENTAZIONE DELL'IMPIANTO	50
3.1 Pannello posteriore.....	50
3.2 Pannello prese.....	50
3.3 Pannello comandi frontale.....	51
4. UTILIZZO DELL'IMPIANTO.....	52
4.1 Schermata di avvio.....	52
4.2 Schermata principale.....	52
4.3 Schermata principale processo MMA.....	52
5. SETUP.....	56
5.1 Set up e impostazione dei parametri	56
5.2 Procedure specifiche di utilizzo dei parametri	63
6. MANUTENZIONE.....	67
6.1 Controlli periodici	67
6.2 Responsabilità.....	67
7. CODIFICA ALLARMI	67
8. DIAGNOSTICA E SOLUZIONI	69
9. ISTRUZIONI OPERATIVE	72
9.1 Saldatura con elettrodo rivestito (MMA).....	72
9.2 Saldatura TIG (arco continuo).....	73
10. CARATTERISTICHE TECNICHE	75
11. TARGA DATI.....	76
12. SIGNIFICATO TARGA DATI	76
13. SCHEMA.....	438
14. CONNETTORI	440
15. LISTA RICAMBI.....	441

SIMBOLOGIA



Avvertenze



Divieti



Obblighi



Indicazioni generali

IT

1. AVVERTENZE

IT



Prima di iniziare qualsiasi operazione siate sicuri di aver ben letto e compreso questo manuale.

Non apportate modifiche e non eseguite manutenzioni non descritte. Il produttore non si fa carico di danni a persone o cose, occorsi per incuria nella lettura o nella messa in pratica di quanto scritto in questo manuale. Conservare sempre le istruzioni per l'uso sul luogo d'impiego dell'apparecchio. Oltre alle istruzioni per l'uso, attenersi alle norme generali e ai regolamenti locali vigenti in materia di prevenzione degli incidenti e tutela dell'ambiente.

La **voestalpine Böhler Welding Selco S.r.l.** si riserva il diritto di apportare modifiche in qualsiasi momento e senza alcun preavviso.

I diritti di traduzione, di riproduzione e di adattamento, totale o parziale e con qualsiasi mezzo (compresi le copie fotostatiche, i film ed i microfilm) sono riservati e vietati senza l'autorizzazione scritta della **voestalpine Böhler Welding Selco S.r.l.**

Quanto esposto è di vitale importanza e pertanto necessario affinché le garanzie possano operare.

Nel caso l'operatore non si attenesse a quanto descritto, il costruttore declina ogni responsabilità.



Tutte le persone addette alla messa in funzione, all'utilizzo, alla manutenzione e alla riparazione dell'apparecchio devono

- essere in possesso di apposita qualifica
- disporre delle competenze necessarie in materia di saldatura
- leggere integralmente e osservare scrupolosamente le presenti istruzioni per l'uso.

Per ogni dubbio o problema circa l'utilizzo dell'impianto, anche se qui non descritto, consultare personale qualificato.

1.1 Ambiente di utilizzo



Ogni impianto deve essere utilizzato esclusivamente per le operazioni per cui è stato progettato, nei modi e nei campi previsti in targa dati e/o in questo manuale, secondo le direttive nazionali e internazionali relative alla sicurezza. Un utilizzo diverso da quello espressamente dichiarato dal costruttore è da considerarsi totalmente inappropriato e pericoloso e in tal caso il costruttore declina ogni responsabilità.



Questo apparecchio deve essere usato solo a scopo professionale in un ambiente industriale. Il costruttore non risponderà di danni provocati dall'uso dell'impianto in ambienti domestici.



L'impianto deve essere utilizzato in ambienti con temperatura compresa tra i -10°C e i +40°C (tra i +14°F e i +104°F).

L'impianto deve essere trasportato e immagazzinato in ambienti con temperatura compresa tra i -25°C e i +55°C (tra i -13°F e i 131°F).

L'impianto deve essere utilizzato in ambienti privi di polvere, acidi, gas o altre sostanze corrosive.

L'impianto deve essere utilizzato in ambienti con umidità relativa non superiore al 50% a 40°C (104°F).

L'impianto deve essere utilizzato in ambienti con umidità relativa non superiore al 90% a 20°C (68°F).

L'impianto deve essere utilizzato ad una altitudine massima sul livello del mare di 2000m (6500 piedi).



Non utilizzare tale apparecchiatura per scongelare tubi.

Non utilizzare tale apparecchiatura per caricare batterie e/o accumulatori.

Non utilizzare tale apparecchiatura per far partire motori.

1.2 Protezione personale e di terzi



Il processo di saldatura è fonte nociva di radiazioni, rumore, calore ed esalazioni gassose. Sistemare una parete divisoria ignifuga per proteggere la zona di saldatura da raggi, scintille e scorie incandescenti. Avvertire le eventuali terze persone di non fissare con lo sguardo la saldatura e di proteggersi dai raggi dell'arco e dal metallo incandescente.



Indossare indumenti di protezione per proteggere la pelle dai raggi dell'arco e dalle scintille o dal metallo incandescente. Gli indumenti utilizzati devono coprire tutto il corpo e devono essere:

- integri e in buono stato
- ignifughi
- isolanti e asciutti
- aderenti al corpo e privi di risvolti



Utilizzare sempre calzature a normativa, resistenti e in grado di garantire l'isolamento dall'acqua.



Utilizzare sempre guanti a normativa, in grado di garantire l'isolamento elettrico e termico.



Utilizzare maschere con protezioni laterali per il viso e filtro di protezione idoneo (almeno NR10 o maggiore) per gli occhi.



Indossare sempre occhiali di sicurezza con schermi laterali specialmente nell'operazione manuale o meccanica di rimozione delle scorie di saldatura.



Non utilizzare lenti a contatto!



Utilizzare cuffie antirumore se il processo di saldatura diviene fonte di rumorosità pericolosa. Se il livello di rumorosità supera i limiti di legge, delimitare la zona di lavoro ed accertarsi che le persone che vi accedono siano protette con cuffie o auricolari.



Tenere sempre i pannelli laterali chiusi durante le operazioni di saldatura. L'impianto non deve essere sottoposto ad alcun tipo di modifica.



Evitare di toccare i pezzi appena saldati, l'elevato calore potrebbe causare gravi ustioni o scottature.



Mantenere tutte le precauzioni precedentemente descritte anche nelle lavorazioni post saldatura in quanto, dai pezzi lavorati che si stanno raffreddando, potrebbero staccarsi scorie.



Assicurarsi che la torcia si sia raffreddata prima di eseguire lavorazioni o manutenzioni.



Assicurarsi che il gruppo di raffreddamento sia spento prima di sconnettere i tubi di mandata e ritorno del liquido refrigerante. Il liquido caldo in uscita potrebbe causare gravi ustioni o scottature.



Provvedere ad un'attrezzatura di pronto soccorso.
Non sottovalutare scottature o ferite.



Prima di lasciare il posto di lavoro, porre in sicurezza l'area di competenza in modo da impedire danni accidentali a cose o persone.

1.3 Protezione da fumi e gas



Fumi, gas e polveri prodotti dal processo di saldatura possono risultare dannosi alla salute.

I fumi prodotti durante il processo di saldatura possono, in determinate circostanze, provocare il cancro o danni al feto nelle donne in gravidanza.

- Tenere la testa lontana dai gas e dai fumi di saldatura.
- Prevedere una ventilazione adeguata, naturale o forzata, nella zona di lavoro.
- In caso di aerazione insufficiente utilizzare maschere dotate di respiratori.
- Nel caso di saldature in ambienti angusti è consigliata la sorveglianza dell'operatore da parte di un collega situato esternamente.
- Non usare ossigeno per la ventilazione.
- Verificare l'efficacia dell'aspirazione controllando periodicamente l'entità delle emissioni di gas nocivi con i valori ammessi dalle norme di sicurezza.
- La quantità e la pericolosità dei fumi prodotti è riconducibile al materiale base utilizzato, al materiale d'apporto e alle eventuali sostanze utilizzate per la pulizia e lo sgrassaggio dei pezzi da saldare. Seguire attentamente le indicazioni del costruttore e le relative schede tecniche.
- Non eseguire operazioni di saldatura nei pressi di luoghi di sgrassaggio o verniciatura.
- Posizionare le bombole di gas in spazi aperti o con un buon ricircolo d'aria.

1.4 Prevenzione incendio/scoppio



Il processo di saldatura può essere causa di incendio e/o scoppio.

- Sgomberare dalla zona di lavoro e circostante i materiali o gli oggetti infiammabili o combustibili.
- I materiali infiammabili devono trovarsi ad almeno 11 metri (35 piedi) dalla zona di lavoro o devono essere opportunamente protetti.
- Le proiezioni di scintille e di particelle incandescenti possono facilmente raggiungere le zone circostanti anche attraverso piccole aperture. Porre particolare attenzione nella messa in sicurezza di cose e persone.
- Non eseguire saldature sopra o in prossimità di recipienti in pressione.
- Non eseguire operazioni di saldatura su recipienti o tubi chiusi. Porre comunque particolare attenzione nella saldatura di tubi o recipienti anche nel caso questi siano stati aperti, svuotati e accuratamente puliti. Residui di gas, carburante, olio o simili potrebbe causare esplosioni.
- Non saldare in atmosfera contenente polveri, gas o vapori esplosivi.
- Accertarsi, a fine lavoro, che il circuito in tensione non possa accidentalmente toccare parti collegate al circuito di massa.
- Predisporre nelle vicinanze della zona di lavoro un'attrezzatura o un dispositivo antincendio.

1.5 Prevenzione nell'uso delle bombole di gas



Le bombole di gas inerte contengono gas sotto pressione e possono esplodere nel caso non vengano assicurate le condizioni minime di trasporto, mantenimento e uso.

- Le bombole devono essere vincolate verticalmente a pareti o ad altro, con mezzi idonei, per evitare cadute o urti meccanici accidentali.
- Avvitare il cappuccio a protezione della valvola durante il trasporto, la messa in servizio e ogni qualvolta le operazioni di saldatura siano terminate.
- Evitare che le bombole siano esposte direttamente ai raggi solari e a sbalzi elevati di temperatura. Non esporre le bombole a temperature troppo rigide o troppo alte.
- Evitare che le bombole entrino in contatto con fiamme libere, con archi elettrici, con torce o pinze porta elettrodo, con le proiezioni incandescenti prodotte dalla saldatura.
- Tenere le bombole lontano dai circuiti di saldatura e dai circuiti di corrente in genere.
- Tenere la testa lontano dal punto di fuoriuscita del gas quando si apre la valvola della bombola.
- Chiudere sempre la valvola della bombola quando le operazioni di saldatura sono terminate.
- Non eseguire mai saldature su una bombola di gas in pressione.
- Non collegare mai una bombola di aria compressa direttamente al riduttore della macchina! La pressione potrebbe superare la capacità del riduttore che quindi potrebbe esplodere!

1.6 Protezione da shock elettrico



Uno shock da scarica elettrica può essere mortale.

- Evitare di toccare parti normalmente in tensione interne o esterne all'impianto di saldatura mentre l'impianto stesso è alimentato (torce, pinze, cavi massa, elettrodi, fili, rulli e bobine sono elettricamente collegati al circuito di saldatura).
- Assicurare l'isolamento elettrico dell'impianto e dell'operatore utilizzando piani e basamenti asciutti e sufficientemente isolati dal potenziale di terra e di massa.
- Assicurarsi che l'impianto venga allacciato correttamente ad una spina e ad una rete provvista del conduttore di protezione a terra.
- Non toccare contemporaneamente due torce o due pinze portaelettrodo.
- Interrompere immediatamente le operazioni di saldatura se si avverte la sensazione di scossa elettrica.



Il dispositivo di innesco e stabilizzazione dell'arco è progettato per il funzionamento a guida manuale o meccanica.



L'aumento della lunghezza della torcia o dei cavi di saldatura ad oltre 8m aumenterà il rischio di scossa elettrica.

1.7 Campi elettromagnetici ed interferenze



Il passaggio della corrente attraverso i cavi interni ed esterni all'impianto, crea un campo elettromagnetico nelle immediate vicinanze dei cavi e dell'impianto stesso.

- I campi elettromagnetici possono avere effetti (ad oggi sconosciuti) sulla salute di chi ne subisce una esposizione prolungata.
- I campi elettromagnetici possono interferire con altre apparecchiature quali pace-maker o apparecchi acustici.



I portatori di apparecchiature elettroniche vitali (pace-maker) devono consultare il medico prima di avvicinarsi alle operazioni di saldatura ad arco.

1.7.1 Classificazione EMC in accordo con la norma: EN 60974-10/A1:2015.

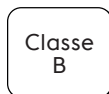

L'apparecchiatura di Classe B è conforme con i requisiti di compatibilità elettromagnetica in ambienti industriali e residenziali, incluse aree residenziali dove l'energia elettrica è fornita da un sistema pubblico a bassa tensione.

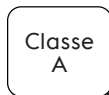

L'apparecchiatura di Classe A non è intesa per l'uso in aree residenziali dove l'energia elettrica è fornita da un sistema pubblico a bassa tensione. Può essere potenzialmente difficile assicurare la compatibilità elettromagnetica di apparecchiature di classe A in questi aree, a causa di disturbi irradiati e condotti.

Per maggiori informazioni consultare: TARGA DATI o CARATTERISTICHE TECNICHE.

1.7.2 Installazione, uso e valutazione dell'area

Questo apparecchio è costruito in conformità alle indicazioni contenute nella norma armonizzata: EN 60974-10/A1:2015 ed è identificato come di "CLASSE A". Questo apparecchio deve essere usato solo a scopo professionale in un ambiente industriale. Il costruttore non risponderà di danni provocati dall'uso dell'impianto in ambienti domestici.



L'utilizzatore deve essere un esperto del settore ed in quanto tale è responsabile dell'installazione e dell'uso dell'apparecchio secondo le indicazioni del costruttore. Qualora vengano rilevati dei disturbi elettromagnetici, spetta all'utilizzatore dell'apparecchio risolvere la situazione avvalendosi dell'assistenza tecnica del costruttore.



In tutti i casi i disturbi elettromagnetici devono essere ridotti fino al punto in cui non costituiscono più un fastidio.



Prima di installare questo apparecchio, l'utilizzatore deve valutare i potenziali problemi elettromagnetici che si potrebbero verificare nell'area circostante e in particolare la salute delle persone circostanti, per esempio: utilizzatori di pace-maker e di apparecchi acustici.

1.7.3 Requisiti alimentazione di rete

Apparecchiature ad elevata potenza possono influenzare la qualità dell'energia della rete di distribuzione a causa della corrente assorbita. Conseguentemente, alcune restrizioni di connessione o alcuni requisiti riguardanti la massima impedenza di rete ammessa (Z_{max}) o la minima potenza d'installazione (S_{sc}) disponibile al punto di interfaccia con la rete pubblica (punto di accoppiamento comune - Point of Common Coupling PCC) possono essere applicati per alcuni tipi di apparecchiature (vedi dati tecnici). In questo caso è responsabilità dell'installatore o dell'utilizzatore assicurarsi, con la consultazione del gestore della rete se necessario, che l'apparecchiatura possa essere connessa. In caso di interferenza potrebbe essere necessario prendere ulteriori precauzioni quali il filtraggio dell'alimentazione di rete.

Si deve inoltre considerare la possibilità di schermare il cavo d'alimentazione.

Per maggiori informazioni consultare: CARATTERISTICHE TECNICHE.

1.7.4 Precauzioni riguardo i cavi

Per minimizzare gli effetti dei campi elettromagnetici, seguire le seguenti regole:

- Arrotolare insieme e fissare, dove possibile, cavo massa e cavo potenza.
- Evitare di arrotolare i cavi intorno al corpo.
- Evitare di fraporsi tra il cavo di massa e il cavo di potenza (tenere entrambi dallo stesso lato).
- I cavi devono essere tenuti più corti possibile e devono essere posizionati vicini e scorrere su o vicino il livello del suolo.
- Posizionare l'impianto ad una certa distanza dalla zona di lavoro.
- I cavi devono essere posizionati lontano da eventuali altri cavi presenti.

1.7.5 Collegamento equipotenziale

Il collegamento a massa di tutti i componenti metallici nell'impianto di saldatura e nelle sue vicinanze deve essere preso in considerazione. Rispettare le normative nazionali riguardanti il collegamento equipotenziale.

1.7.6 Messa a terra del pezzo in lavorazione

Dove il pezzo in lavorazione non è collegato a terra, per motivi di sicurezza elettrica o a causa della dimensione e posizione, un collegamento a massa tra il pezzo e la terra potrebbe ridurre le emissioni. Bisogna prestare attenzione affinché la messa a terra del pezzo in lavorazione non aumenti il rischio di infortunio degli utilizzatori o danneggi altri apparecchi elettrici. Rispettare le normative nazionali riguardanti la messa a terra.

1.7.7 Schermatura

La schermatura selettiva di altri cavi e apparecchi presenti nell'area circostante può alleviare i problemi di interferenza.

La schermatura dell'intero impianto di saldatura può essere presa in considerazione per applicazioni speciali.

1.8 Grado di protezione IP



IP23S

- Involucro protetto contro l'accesso a parti pericolose con un dito e contro corpi solidi estranei di diametro maggiore o uguale a 12,5 mm.
- Involucro protetto contro pioggia a 60° sulla verticale.
- Involucro protetto dagli effetti dannosi dovuti all'ingresso d'acqua, quando le parti mobili dell'apparecchiatura non sono in moto.

1.9 Smaltimento



Non collocare l'apparecchiatura elettrica tra i normali rifiuti!

In osservanza alla Direttiva Europea 2012/19/EU sui Rifiuti di Apparecchiature Elettriche ed Elettroniche e alla sua implementazione in accordo con le leggi nazionali, le apparecchiature elettriche che hanno raggiunto la fine del ciclo di vita devono essere raccolte separatamente e inviate ad un centro di recupero e smaltimento. Il proprietario dell'apparecchiatura dovrà identificare i centri di raccolta autorizzati informandosi presso le Amministrazioni Locali. L'applicazione della Direttiva Europea permetterà di migliorare l'ambiente e la salute umana.

» Per maggiori informazioni consultare il sito.

2. INSTALLAZIONE



L'installazione può essere effettuata solo da personale esperto ed abilitato dal produttore.



Per l'installazione assicurarsi che il generatore sia scollegato dalla rete di alimentazione.



È vietata la connessione (in serie o parallelo) dei generatori.

2.1 Modalità di sollevamento, trasporto e scarico

• L'impianto è provvisto di un manico che ne permette la movimentazione a mano.



Non sottovalutare il peso dell'impianto, vedi caratteristiche tecniche.

Non far transitare o sostare il carico sospeso sopra a persone o cose.

Non lasciare cadere o appoggiare con forza l'impianto o la singola unità.

2.2 Posizionamento dell'impianto



Osservare le seguenti norme:

- Facile accesso ai comandi ed ai collegamenti.
- Non posizionare l'attrezzatura in ambienti angusti.
- Non posizionare mai l'impianto su di un piano con inclinazione maggiore di 10° dal piano orizzontale.
- Collocare l'impianto in un luogo asciutto, pulito e con ventilazione appropriata.
- Proteggere l'impianto contro la pioggia battente e contro il sole.

2.3 Allacciamento



Il generatore è provvisto di un cavo di alimentazione per l'allacciamento alla rete.

L'impianto può essere alimentato con:

- 230V trifase
- 400V trifase

Il funzionamento dell'apparecchiatura è garantito per tensioni che si discostano fino al $\pm 15\%$ dal valore nominale.



Per evitare danni alle persone o all'impianto, occorre controllare la tensione di rete selezionata e i fusibili PRIMA di collegare la macchina alla rete. Inoltre occorre assicurarsi che il cavo venga collegato a una presa fornita di contatto di terra.



È possibile alimentare l'impianto attraverso un gruppo elettrogeno purché questo garantisca una tensione di alimentazione stabile tra il $\pm 15\%$ rispetto al valore di tensione nominale dichiarato dal costruttore, in tutte le condizioni operative possibili e alla massima potenza erogabile dal generatore. Di norma, si consiglia l'uso di gruppi elettrogeni di potenza pari a 2 volte la potenza del generatore se monofase e pari a 1.5 volte se trifase. Si consiglia l'uso di gruppi elettrogeni a controllo elettronico.



Per la protezione degli utenti, l'impianto deve essere correttamente collegato a terra. Il cavo di alimentazione è provvisto di un conduttore (giallo - verde) per la messa a terra, che deve essere collegato ad una spina dotata di contatto a terra. Questo filo giallo/verde non deve MAI essere usato insieme ad altro filo per prelievi di tensione. Controllare l'esistenza della "messa a terra" nell'impianto utilizzato ed il buono stato della presa di corrente. Montare solo spine omologate secondo le normative di sicurezza.



L'impianto elettrico deve essere realizzato da personale tecnico in possesso di requisiti tecnico-professionali specifici e in conformità alle leggi dello stato in cui si effettua l'installazione.

2.4 Messa in servizio

2.4.1 Collegamento per saldatura MMA



Il collegamento in figura dà come risultato una saldatura con polarità inversa. Per ottenere una saldatura con polarità diretta, invertire il collegamento.

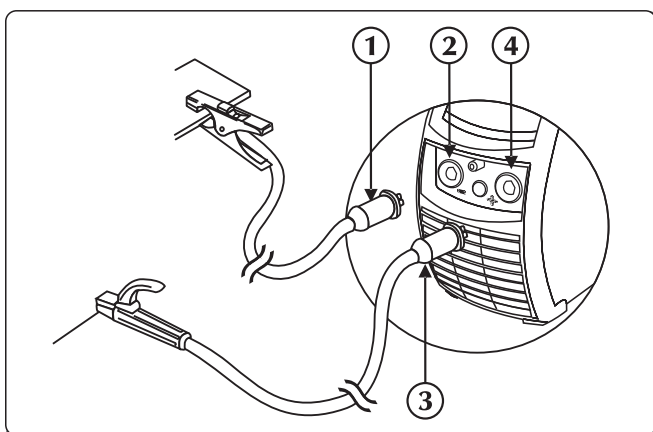



- ① Connettore pinza massa
- ② Presa negativa di potenza (-)
- ③ Connettore pinza portaelettrodo
- ④ Presa positiva di potenza (+)

- ▶ Collegare il connettore del cavo della pinza di massa alla presa negativa (-) del generatore. Inserire la spina e ruotare in senso orario fino al completo fissaggio delle parti.
- ▶ Collegare il connettore del cavo della pinza portaelettrodo alla presa positiva (+) del generatore. Inserire la spina e ruotare in senso orario fino al completo fissaggio delle parti.

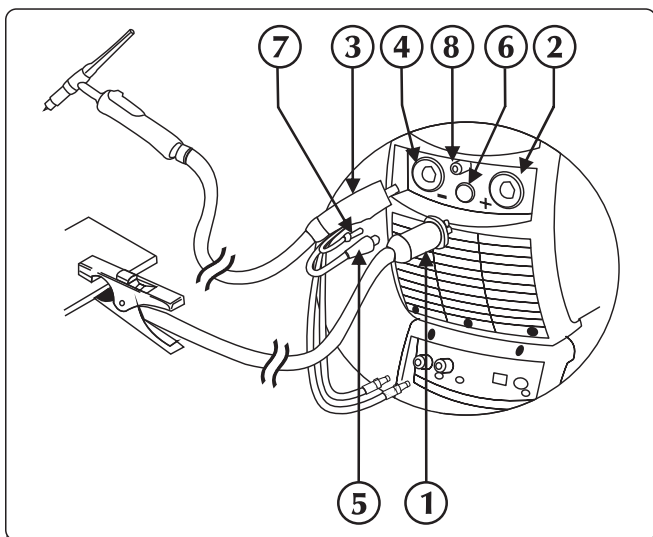
2.4.2 Collegamento per saldatura TIG



- ① Connettore pinza massa
- ② Presa positiva di potenza (+)
- ③ Attacco torcia TIG
- ④ Presa torcia
- ⑤ Cavo segnale torcia
- ⑥ Connettore
- ⑦ Tubo gas torcia
- ⑧ Raccordo-innesto gas

- ▶ Collegare il connettore del cavo della pinza di massa alla presa positiva (+) del generatore. Inserire la spina e ruotare in senso orario fino al completo fissaggio delle parti.
- ▶ Collegare l'attacco della torcia TIG alla presa torcia del generatore. Inserire la spina e ruotare in senso orario fino al completo fissaggio delle parti.
- ▶ Collegare il cavo di segnale della torcia all'apposito connettore.
- ▶ Collegare il tubo gas della torcia all'apposito raccordo/innesto.
- ▶ Collegare il tubo di ritorno liquido refrigerante della torcia (colore rosso) all'apposito raccordo/innesto  (colore rosso).
- ▶ Collegare il tubo di mandata liquido refrigerante della torcia (colore blu) all'apposito raccordo/innesto  (colore blu).

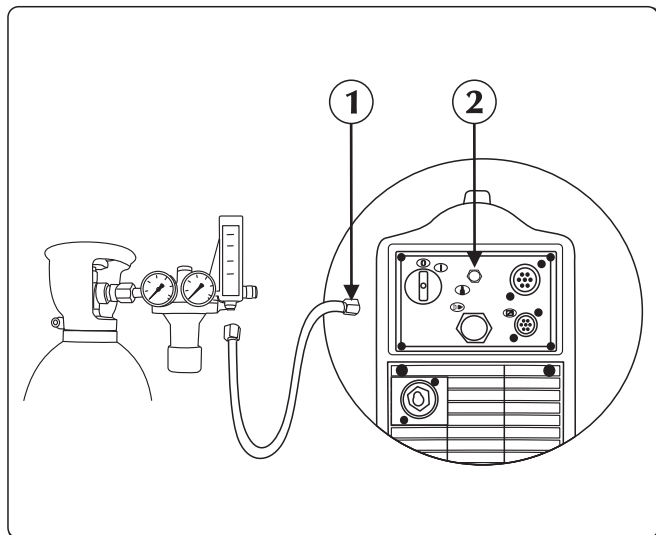

- ① Tubo gas
- ② Raccordo-innesto gas

► Collegare il tubo gas proveniente dalla bombola al raccordo gas posteriore. Regolare il flusso gas da 5 a 15 l/min.

3. PRESENTAZIONE DELL'IMPIANTO

3.1 Pannello posteriore

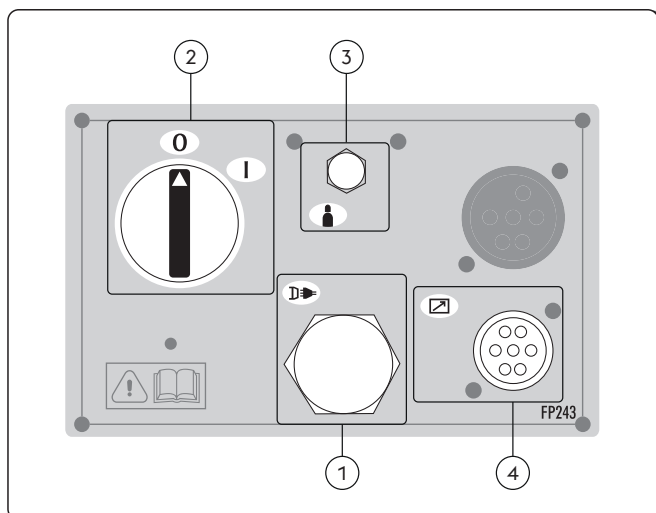

- ① Cavo di alimentazione
Permette di alimentare l'impianto collegandolo alla rete.
- ② Interruttore di accensione
Comanda l'accensione elettrica dell'impianto.
Ha due posizioni: "0" spento; "I" acceso.
- ③ Attacco gas
- ④ Ingresso cavo di segnale CAN-BUS (RC, RI...)

3.2 Pannello prese

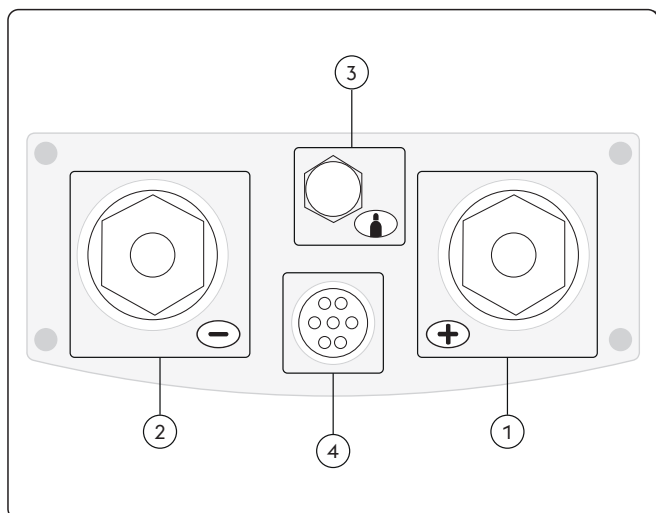





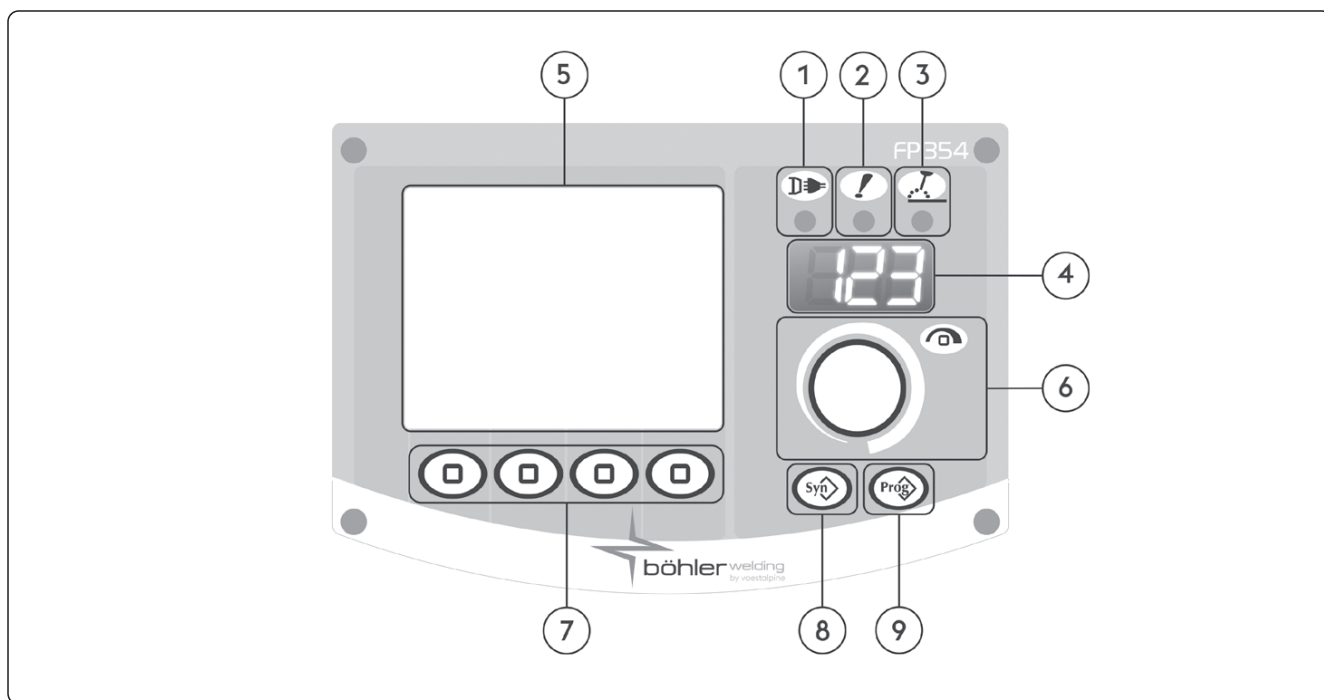



- ① Presa positiva di potenza (+)
Processo MMA: Connessione torcia ad elettrodo
Processo TIG: Connessione cavo di massa
- ② Presa negativa di potenza (-)
Processo MMA: Connessione cavo di massa
Processo TIG: Connessione torcia
- ③ Attacco gas
- ④ Ingresso cavo di segnale (Torcia TIG)

3.3 Pannello comandi frontale



IT

- 1  **LED di alimentazione**
Indica che l'impianto è collegato alla rete elettrica e che è alimentato.
- 2  **LED di allarme generale**
Indica l'eventuale intervento dei dispositivi di protezione quali la protezione termica.
- 3  **LED di potenza attiva**
Indica la presenza di tensione sulle prese d'uscita dell'impianto.
- 4  **Display a 7 segmenti**
Permette di visualizzare le generalità della saldatrice in fase di partenza, le impostazioni e le letture di corrente e di tensione in saldatura, la codifica degli allarmi.
- 5  **Display LCD**
Permette di visualizzare le generalità della saldatrice in fase di partenza, le impostazioni e le letture di corrente e di tensione in saldatura, la codifica degli allarmi.
Permette di visualizzare istantaneamente tutte le operazioni.
- 6  **Manopola di regolazione principale**
Permette di regolare con continuità la corrente di saldatura.
Permette l'ingresso a set up, la selezione e l'impostazione dei parametri di saldatura.
- 7  **Tasti funzione**
Permettono la selezione delle varie funzionalità dell'impianto:
- Processo di saldatura
- Modalità di saldatura
- Pulsazione di corrente
- Modalità grafica
- 8  **Tasto non utilizzato**
- 9  **Tasto Job**
Permette la memorizzazione e la gestione di 240 job personalizzabili dall'operatore.

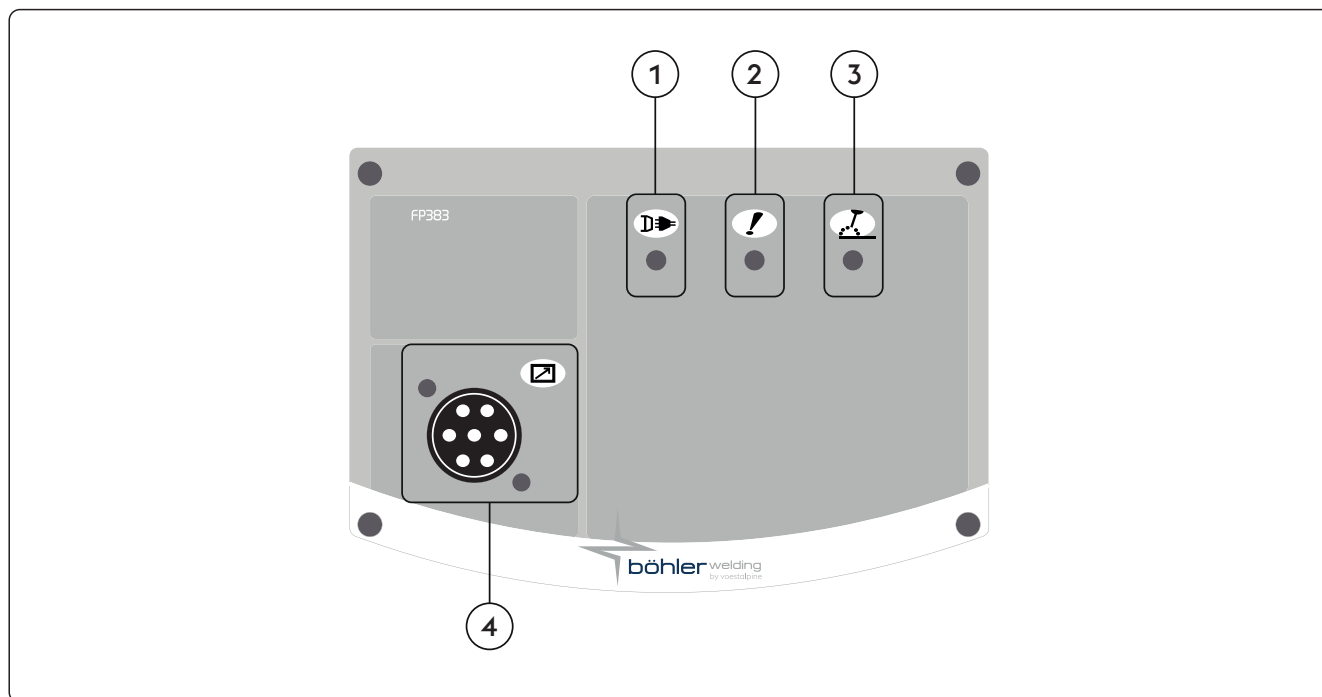

- ① **LED di alimentazione**
Indica che l'impianto è collegato alla rete elettrica e che è alimentato.
- ② **LED di allarme generale**
Indica l'eventuale intervento dei dispositivi di protezione quali la protezione termica.
- ③ **LED di potenza attiva**
Indica la presenza di tensione sulle prese d'uscita dell'impianto.
- ④ **Ingresso cavo di segnale CAN-BUS (RC, RI...)**

4. UTILIZZO DELL'IMPIANTO

4.1 Schermata di avvio

All'accensione, l'impianto esegue una serie di verifiche atte a garantirne il corretto funzionamento ed anche di tutti i dispositivi ad esso connessi. In questa fase viene anche eseguito il test gas per accertare il corretto allacciamento al sistema di alimentazione del gas.

4.2 Schermata principale

Permette la gestione dell'impianto e del processo di saldatura, mostrando le impostazioni principali.

4.3 Schermata principale processo MMA

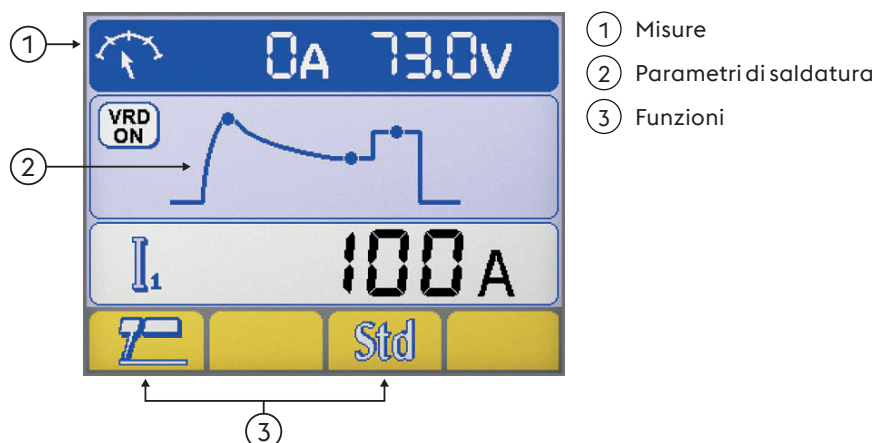

Misure

Durante le fasi di saldatura, sul display LCD vengono visualizzate le misure reali di corrente e di tensione.



Parametri di saldatura

► Selezionare il parametro desiderato premendo il tasto encoder.

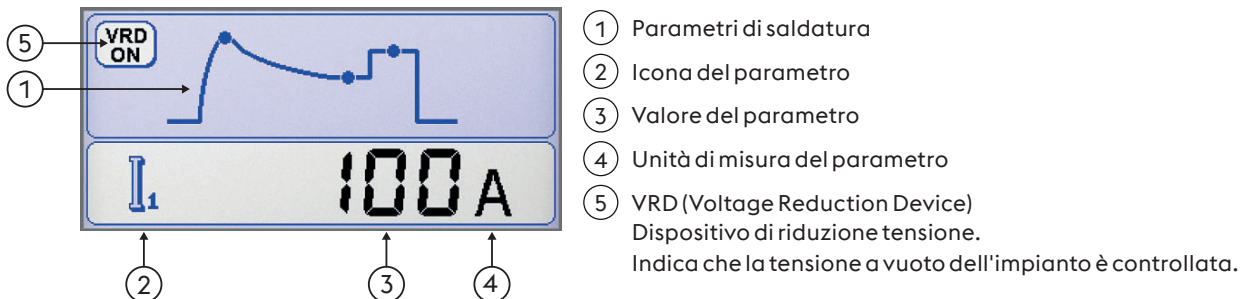

Funzioni

Permettono l'impostazione delle funzionalità di processo e delle modalità di saldatura più importanti.

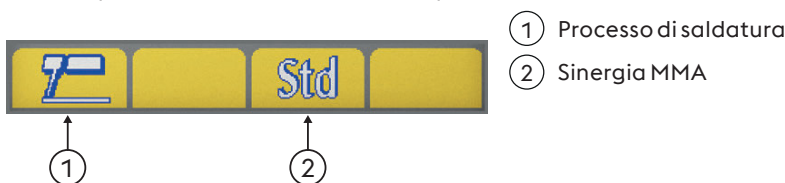

Processo di saldatura

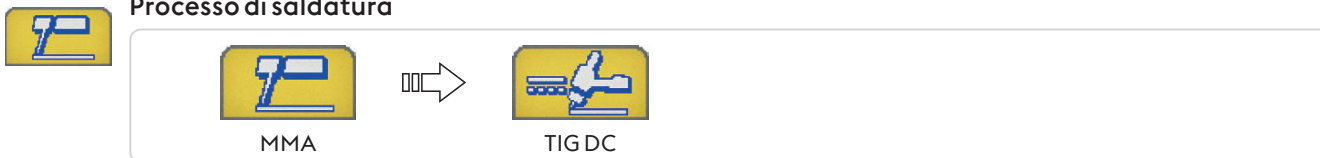

Sinergia MMA

Permette di impostare la migliore dinamica d'arco selezionando il tipo di elettrodo utilizzato.

La selezione della corretta dinamica d'arco permette di sfruttare nel migliore dei modi le potenzialità dell'impianto al fine di ottenere le migliori prestazioni possibili in saldatura.



Non viene garantita la perfetta saldabilità dell'elettrodo utilizzato.

La saldabilità dipende dalla qualità dei consumabili e dalla loro conservazione, dalle modalità operative e dalle condizioni di saldatura, dalle numerose applicazioni possibili.

4.4 Schermata principale processo TIG

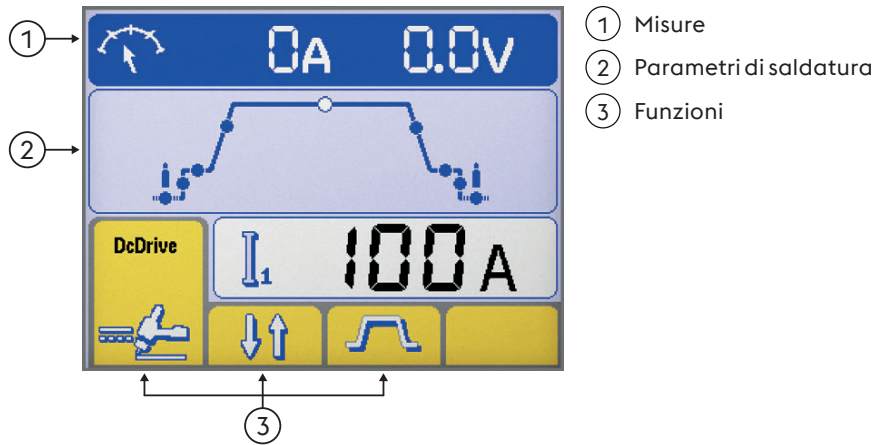

Misure

Durante le fasi di saldatura, sul display LCD vengono visualizzate le misure reali di corrente e di tensione.

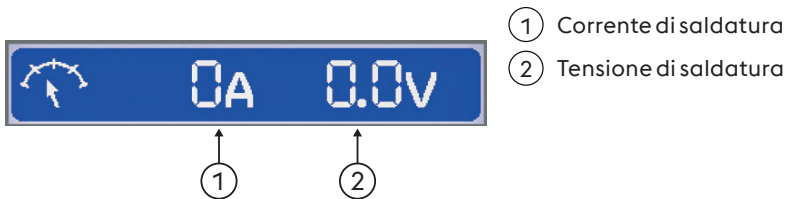

Parametri di saldatura

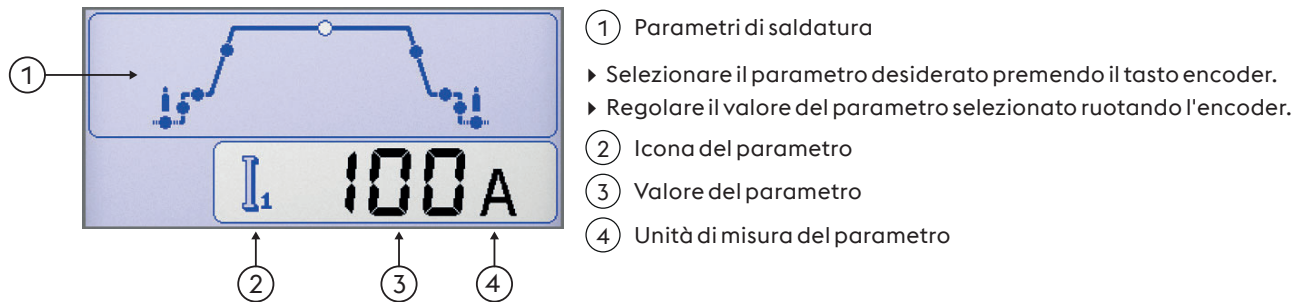

Funzioni

Permettono l'impostazione delle funzionalità di processo e delle modalità di saldatura più importanti.

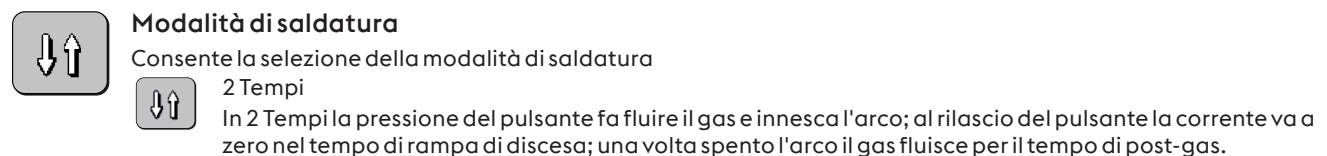
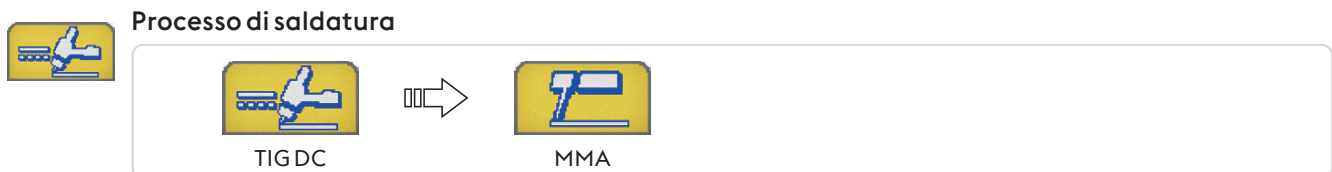
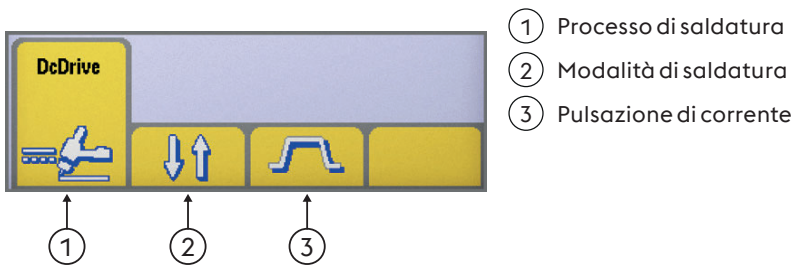



4 Tempi

In quattro tempi la prima pressione del pulsante fa fluire il gas effettuando un pre-gas manuale; al rilascio si ha l'innesco dell'arco. La successiva pressione e rilascio definitivo del pulsante fa iniziare la rampa di discesa della corrente e il tempo di post-gas.



Bilevel

In bilevel il saldatore può saldare con due diverse correnti impostate in precedenza. Alla prima pressione del pulsante torcia si ha il pre-gas, l'innesco dell'arco e la saldatura con corrente iniziale. Al primo rilascio si ha la rampa di salita alla corrente "I1". Se il saldatore preme e rilascia velocemente il pulsante si passa ad "I2". Premendo e rilasciando velocemente il pulsante si ritorna ad "I1" e così via. Premendo per un tempo più lungo ha inizio la rampa di discesa della corrente che porta alla corrente finale. Rilasciando il pulsante ho lo spegnimento dell'arco mentre il gas continua a fluire per il tempo di post-gas.



Pulsazione di corrente



Corrente costante



Corrente pulsata



Fast Pulse



EasyArc

4.5 Schermata programmi



Permette la memorizzazione e la gestione di 240 job personalizzabili dall'operatore.

Programmi (JOB)

Consultare la sezione "Schermata principale"

Memorizzazione programma

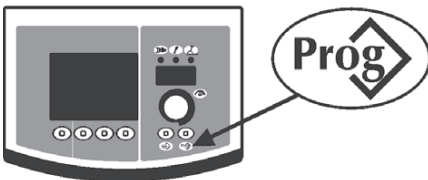

- ▶ Entrare nella schermata "memorizzazione programma" premendo il tasto per almeno un secondo.



- ▶ Selezionare il programma (o la memoria vuota) desiderato ruotando l'encoder.

--- Memoria vuota

Programma memorizzato

- ▶ Annullare l'operazione premendo il tasto .
- ▶ Salvare tutte le impostazioni correnti sul programma selezionato premendo il tasto .

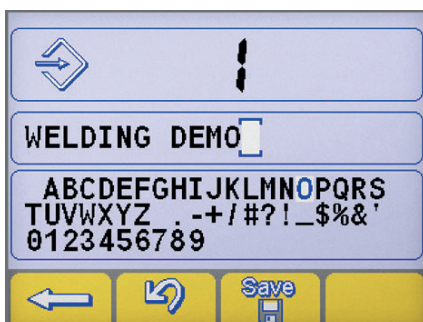

Inserire una descrizione del programma.

- ▶ Selezionare la lettera desiderata ruotando l'encoder.
- ▶ Memorizzare la lettera selezionata premendo l'encoder.
- ▶ Cancellare l'ultima lettera premendo il tasto .
- ▶ Annullare l'operazione premendo il tasto .
- ▶ Confermare l'operazione premendo il tasto .



La memorizzazione di un nuovo programma su una memoria già occupata implica la cancellazione della memoria attraverso una procedura obbligatoria.



- ▶ Annullare l'operazione premendo il tasto
- ▶ Eliminare il programma selezionato premendo il tasto
- ▶ Riprendere la procedura di memorizzazione.

Richiamo programmi

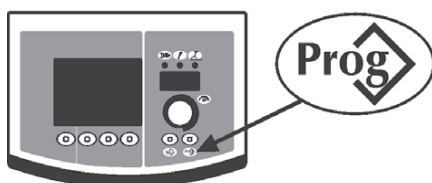

- ▶ Richiamare il 1° programma disponibile premendo il tasto
 - ▶ Selezionare il programma desiderato ruotando l'encoder.
 - ▶ Selezionare il programma desiderato premendo il tasto
- Vengono richiamate solamente le memorie occupate da un programma, mentre quelle vuote vengono automaticamente saltate.

Cancellazione programmi



- ▶ Selezionare il programma desiderato ruotando l'encoder.
- ▶ Eliminare il programma selezionato premendo il tasto
- ▶ Annullare l'operazione premendo il tasto



- ▶ Annullare l'operazione premendo il tasto
- ▶ Eliminare il programma selezionato premendo il tasto

5. SETUP

5.1 Set up e impostazione dei parametri

Permette l'impostazione e la regolazione di una serie di parametri aggiuntivi per una migliore e più precisa gestione dell'impianto di saldatura.

I parametri presenti a set up sono organizzati in relazione al processo di saldatura selezionato e hanno una codifica numerica.

Ingresso a set up





- ▶ Avviene premendo per 5 secondi il tasto encoder.
- ▶ L'entrata sarà confermata dalla scritta 0 sul display.

Selezione e regolazione del parametro desiderato

- ▶ Avviene ruotando l'encoder fino a visualizzare il codice numerico relativo al parametro desiderato.
- ▶ La pressione del tasto encoder, a questo punto, permette la visualizzazione del valore impostato per il parametro selezionato e la sua regolazione.

Uscita da set up

- ▶ Per uscire dalla sezione "regolazione" premere nuovamente l'encoder.
- ▶ Per uscire dal set up portarsi sul parametro "0" (salva ed esci) e premere l'encoder.
- ▶ Annullare l'operazione premendo il tasto .
- ▶ Per salvare la modifica ed uscire dal set up premere il tasto: .

5.1.1 Elenco parametri a set up (MMA)

0

Salva ed esci



Permette di salvare le modifiche e di uscire dal set up.

1

Reset



Permette di reimpostare tutti i parametri ai valori di default.

3

Hot start



Permette la regolazione del valore di hot start in MMA.

Consente una partenza più o meno "calda" nelle fasi d'innesco dell'arco facilitando di fatto le operazioni di start.

Elettrodo Basico

Minimo	Massimo	Default
0/off	500%	80%

Elettrodo Cellulosico

Minimo	Massimo	Default
0/off	500%	150%

Elettrodo CrNi

Minimo	Massimo	Default
0/off	500%	100%

Elettrodo Alluminio

Minimo	Massimo	Default
0/off	500%	120%

Elettrodo Cast Iron

Minimo	Massimo	Default
0/off	500%	100%

Elettrodo Rutilico

Minimo	Massimo	Default
0/off	500%	80%

7

Corrente di saldatura

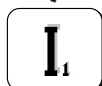

Permette la regolazione della corrente di saldatura.

Minimo	Massimo	Default
3 A	I _{max}	100 A

8

Arc force



Permette la regolazione del valore dell'Arc force in MMA.

Consente una risposta dinamica più o meno energetica in saldatura facilitando di fatto le operazioni del saldatore.

Aumentare il valore dell'Arc force per ridurre i rischi di incollamento dell'elettrodo.

Elettrodo Basico

Minimo	Massimo	Default
0/off	500%	30%

Elettrodo Cellulosico

Minimo	Massimo	Default
0/off	500%	350%

Elettrodo CrNi

Minimo	Massimo	Default
0/off	500%	30%

Elettrodo Alluminio

Minimo	Massimo	Default
0/off	500%	100%

Elettrodo Cast Iron

Minimo	Massimo	Default
0/off	500%	70%

Elettrodo Rutilico

Minimo	Massimo	Default
0/off	500%	80%

204 Dynamic power control (DPC)



Permette la selezione della caratteristica V/I desiderata.

I=C Corrente costante

L'aumento o la riduzione dell'altezza dell'arco non ha alcuna incidenza sulla corrente di saldatura erogata.

Consigliato per elettrodo: Basico, Rutilico, Acido, Acciaio, Ghisa

1÷20 Caratteristica cadente con regolazione di rampa

L'aumento dell'altezza dell'arco provoca la riduzione della corrente di saldatura (e viceversa) secondo il valore impostato da 1 a 20 Ampere per ogni Volt.

Consigliato per elettrodo: Cellulosico, Alluminio

P=C Potenza costante

L'aumento dell'altezza dell'arco provoca la riduzione della corrente di saldatura (e viceversa) secondo la legge: $V \cdot I = K$

Consigliato per elettrodo: Cellulosico, Alluminio

312 Tensione di stacco arco



Permette di impostare il valore di tensione al quale viene forzato lo spegnimento dell'arco elettrico.

Consente di gestire al meglio le varie condizioni operative che si vengono a creare.

In fase di puntatura, per esempio, una bassa tensione di stacco d'arco permette una minore sfiammata nell'allontanamento dell'elettrodo dal pezzo riducendo spruzzi, bruciature e ossidazione del pezzo.



Non impostare mai una tensione di stacco arco maggiore della tensione a vuoto del generatore.

Elettrodo Basico

Minimo	Massimo	Default
0/off	Vmax	57.0 V

Elettrodo Cellulosico

Minimo	Massimo	Default
0/off	Vmax	70.0 V

399 Velocità di spostamento



Permette l'impostazione della velocità di esecuzione della saldatura.

Default cm/min: velocità di riferimento per la saldatura manuale.

Syn: valore sinergico.

Minimo	Massimo	Default
2 cm/min	200 cm/min	15 cm/min

500 Impostazione macchina



Permette la selezione dell'interfaccia grafica desiderata.

Permette di accedere ai livelli superiori del set up.

Consultare la sezione "Personalizzazione interfaccia (Set up 500)"

Valore	Livello selezionato
USER	Utente
SERV	Service
vaBW	vaBW

Valore	Interfaccia Utente
XE	Modalità Easy
XA	Modalità Advanced
XP	Modalità Professional

551 Lock/unlock



Permette il blocco dei comandi del pannello e l'inserzione di un codice di protezione.

Consultare la sezione "Lock/unlock (Set up 551)".

552 Tono cicalino



Permette la regolazione del tono del cicalino.

Minimo	Massimo	Default
0/off	10	10

601 Passo di regolazione



Permette la regolazione di un parametro con passo personalizzabile dall'operatore.

Minimo	Massimo	Default
1	Imax	1

602 Parametro esterno 2



Permette la gestione del parametro esterno 2 (valore minimo, valore massimo, valore di default, parametro selezionato).

- 705 Taratura resistenza circuito**
 Permette la taratura dell'impianto.
 Consultare la sezione "Taratura resistenza circuito (set up 705)".
- 751 Lettura di corrente**
 Permette la visualizzazione del valore reale della corrente di saldatura.
- 752 Lettura di tensione**
 Permette la visualizzazione del valore reale della tensione di saldatura.
- 768 Misura apporto termico HI**
 Permette la lettura del valore della misura dell'apporto termico in saldatura.

5.1.2 Elenco parametri a set up (TIG)

- 0 Salva ed esci**
 Permette di salvare le modifiche e di uscire dal set up.
- 1 Reset**
 Permette di reimpostare tutti i parametri ai valori di default.
- 2 Pre gas**
 Permette di impostare e regolare il flusso di gas prima dell'innesco dell'arco.
 Consente il caricamento del gas in torcia e la preparazione dell'ambiente per la saldatura.
- | Minimo | Massimo | Default |
|--------|---------|---------|
| 0/off | 99.9 s | 0.1 s |
- 3 Corrente iniziale**
 Permette la regolazione della corrente di inizio saldatura.
 Consente di ottenere un bagno di saldatura più o meno caldo nelle fasi immediatamente successive all'innesco.
- | Minimo | Massimo | Default | Minimo | Massimo | Default |
|--------|---------|---------|--------|------------------|---------|
| 1% | 200% | 50% | 3 A | I _{max} | - |
- 5 Tempo corrente iniziale**
 Permette di impostare il tempo nel quale la corrente iniziale viene mantenuta.
- | Minimo | Massimo | Default |
|--------|---------|---------|
| 0/off | 99.9 s | 0/off |
- 6 Rampa di salita**
 Permette di impostare un passaggio graduale tra la corrente iniziale e la corrente di saldatura.
- | Minimo | Massimo | Default |
|--------|---------|---------|
| 0/off | 99.9 s | 0/off |
- 7 Corrente di saldatura**
 Permette la regolazione della corrente di saldatura.
- | Minimo | Massimo | Default |
|--------|------------------|---------|
| 3 A | I _{max} | 100 A |

8 Corrente di bilevel



Permette la regolazione della corrente secondaria nella modalità di saldatura bilevel.

Alla prima pressione del pulsante torcia abbiamo il pregas, l'innesco dell'arco e la saldatura con corrente iniziale.

Al primo rilascio si ha la rampa di salita alla corrente "I1".

Se il saldatore preme e rilascia velocemente il pulsante si passa ad "I2".

Premendo e rilasciando velocemente il pulsante si passa nuovamente ad "I1" e così via.

Premendo per un tempo più lungo ha inizio la rampa di discesa della corrente che porta alla corrente finale.

Rilasciando il pulsante si ha lo spegnimento dell'arco mentre il gas continua a fluire per il tempo di post-gas.

Minimo	Massimo	Default
3 A	I _{max}	-

Minimo	Massimo	Default
1%	500%	off

10 Corrente di base



Permette la regolazione della corrente di base in pulsato e fast pulse.

Minimo	Massimo	Default
3 A	I _{sald}	-

Minimo	Massimo	Default
1%	100%	50%

12 Frequenza pulsato



Permette la regolazione della frequenza di pulsazione.

Consente di ottenere migliori risultati nella saldatura di spessori sottili e migliori qualità estetiche del cordone.

Minimo	Massimo	Default
0.1 Hz	25 Hz	5 Hz

13 Duty cycle pulsato



Permette la regolazione del duty cycle in pulsato.

Consente il mantenimento della corrente di picco per un tempo più o meno lungo.

Minimo	Massimo	Default
1 %	99 %	50 %

14 Frequenza Fast Pulse



Permette la regolazione della frequenza di pulsazione.

Consente di ottenere una maggiore concentrazione e una migliore stabilità dell'arco elettrico.

Minimo	Massimo	Default
0.02 KHz	2.5 KHz	0.25 KHz

15 Rampe pulsato



Permette l'impostazione di un tempo di rampa nella fase di pulsazione.

Consente di ottenere un passaggio graduale tra la corrente di picco e la corrente di base, rendendo di fatto un arco più o meno "morbido".

Minimo	Massimo	Default
0/off	100 %	0/off

16 Rampa di discesa



Permette di impostare un passaggio graduale tra la corrente di saldatura e la corrente finale.

Minimo	Massimo	Default
0/off	99.9 s	0/off

17 Corrente finale



Permette la regolazione della corrente finale.

Minimo	Massimo	Default
3 A	I _{max}	10 A

Minimo	Massimo	Default
1 %	200 %	50 %

19 Tempo corrente finale



Permette di impostare il tempo nel quale la corrente finale viene mantenuta.

Minimo	Massimo	Default
0/off	99.9 s	0/off

20 Post gas



Permette di impostare e regolare il flusso di gas a fine saldatura.

Minimo	Massimo	Default
0/off	99.9 s	syn

203 Tig start (HF)

Permette la selezione della modalità di innesco desiderata.

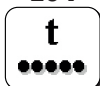
Valore	Default	Funzione Richiamata
on	X	HF START
off	-	LIFT START

204 Puntatura

Permette di abilitare il processo "puntatura" e di stabilire il tempo di saldatura.

Consente la temporizzazione del processo di saldatura.

Minimo	Massimo	Default
0/off	99.9 s	0/off

205 Restart

Permette l'attivazione della funzione restart.

Consente l'immediato spegnimento dell'arco durante la rampa di discesa o la ripartenza del ciclo di saldatura.

Valore	Default	Funzione Richiamata
0/off	-	off
1/on	X	on
2/of1	-	off

206 Easy joining

Permette l'innesco dell'arco in corrente pulsata e la temporizzazione della funzione prima del ripristino automatico delle condizioni di saldatura preimpostate.

Consente una maggiore rapidità e precisione nelle operazioni di puntatura dei pezzi.

Minimo	Massimo	Default
0.1 s	25.0 s	0/off

208 Microtime spot welding

Permette di abilitare il processo "microtime spot welding".

Consente la temporizzazione del processo di saldatura.

Minimo	Massimo	Default
0.01 s	1.00 s	0/off

399 Velocità di spostamento

Permette l'impostazione della velocità di esecuzione della saldatura.

Default cm/min: velocità di riferimento per la saldatura manuale.

Syn: valore sinergico.

Minimo	Massimo	Default
2 cm/min	200 cm/min	10 cm/min

500 Impostazione macchina

Permette la selezione dell'interfaccia grafica desiderata.

Permette di accedere ai livelli superiori del set up.

Consultare la sezione "Personalizzazione interfaccia (Set up 500)"

Valore	Livello selezionato	Valore	Interfaccia Utente
USER	Utente	XE	Modalità Easy
SERV	Service	XA	Modalità Advanced
vaBW	vaBW	XP	Modalità Professional

551 Lock/unlock

Permette il blocco dei comandi del pannello e l'inserzione di un codice di protezione.

Consultare la sezione "Lock/unlock (Set up 551)".

552 Tono cicalino



Permette la regolazione del tono del cicalino.

Minimo	Massimo	Default
0/off	10	10

601 Passo di regolazione



Permette la regolazione di un parametro con passo personalizzabile dall'operatore.

Minimo	Massimo	Default
1	Imax	1

602 Parametro esterno CH1, CH2, CH3, CH4



Permette la gestione del parametro esterno 1, 2, 3, 4 (valore minimo, valore massimo, valore di default, parametro selezionato).

Consultare la sezione "Gestione comandi esterni (Set up 602)".

606 Torcia U/D



Permette la gestione del parametro esterno (U/D).

Valore	Default	Funzione Richiamata
0/off	-	off
1/11	X	Corrente
	-	Richiamo programmi

612 Setting Torcia DgTig



Permette la gestione dei canali della torcia digitale.

Valore	Default	Funzione Richiamata
0/off	-	off
1/11	-	Corrente
2/	-	Richiamo programmi
3/CH3	-	CH3
4/CH4	-	CH4
5/STD	X	STD

705 Taratura resistenza circuito



Permette la taratura dell'impianto.

Consultare la sezione "Taratura resistenza circuito (set up 705)".

751 Lettura di corrente



Permette la visualizzazione del valore reale della corrente di saldatura.

752 Lettura di tensione



Permette la visualizzazione del valore reale della tensione di saldatura.

758 Velocità di spostamento robot



Permette la visualizzazione della velocità di spostamento del braccio di un robot o di una automazione.

764 Lettura flusso liquido refrigerante



Permette la visualizzazione del valore del flusso liquido refrigerante.

765 Lettura di temperatura liquido refrigerante



Permette la visualizzazione del valore reale della temperatura del liquido refrigerante.

768

Misura apporto termico HI

Permette la lettura del valore della misura dell'apporto termico in saldatura.



801

Limiti di guardia

Permette l'impostazione dei limiti di attenzione e dei limiti di guardia.

Permette di controllare il processo di saldatura impostando sui principali parametri misurabili limiti di attenzione e limiti di guardia.

Consente il controllo accurato delle varie fasi di saldatura.





5.2 Procedure specifiche di utilizzo dei parametri

5.2.1 Personalizzazione display 7 segmenti

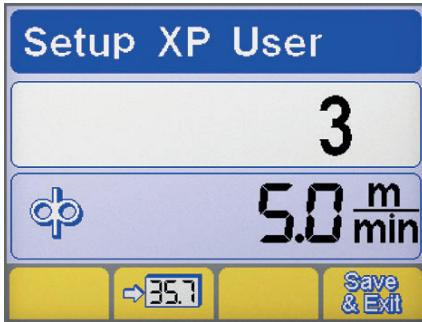
Permette di visualizzare costantemente il valore di un parametro sul display 7 segmenti.



- ▶ Entrare nel set up premendo il tasto encoder per almeno 5 secondi.
- ▶ Selezionare il parametro desiderato ruotando l'encoder.
- ▶ Memorizzare il parametro selezionato nel display 7 segmenti premendo il tasto .
- ▶ Salvare ed uscire dalla schermata corrente premendo il tasto .

5.2.2 Personalizzazione interfaccia (Set up 500)

Permette di personalizzare i parametri nella schermata principale.

500

Impostazione macchina

Permette la selezione dell'interfaccia grafica desiderata.







Valore	Interfaccia Utente
XE	Modalità Easy
XA	Modalità Advanced
XP	Modalità Professional







MODALITÀ XE

MMA

Parametri di saldatura 



TIG





Parametri di saldatura     

Funzioni      









MODALITÀ XA







MMA

Parametri di saldatura   

Funzioni     



TIG





Parametri di saldatura        

Funzioni       













MODALITÀ XP







MMA

Parametri di saldatura   

Funzioni     

TIG

Parametri di saldatura            

Funzioni       

5.2.3 Lock/unlock (Set up 551)

Permette il blocco dei comandi del pannello e l'inserimento di un codice di protezione.

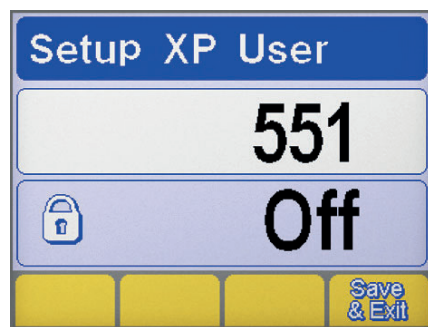

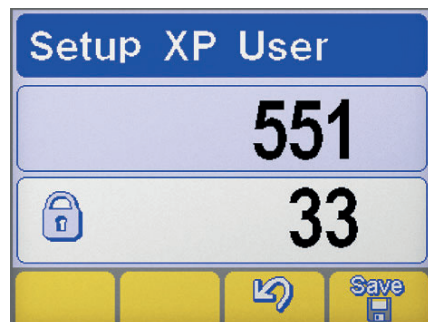

Selezione parametro

- ▶ Entrare nel set up premendo il tasto encoder per almeno 5 secondi.
- ▶ Selezionare il parametro desiderato (551).
- ▶ Attivare la regolazione del parametro selezionato premendo il tasto encoder.



Impostazione password

- ▶ Impostare una codifica numerica (password) ruotando l'encoder.
- ▶ Confermare l'operazione premendo il tasto-encoder.
- ▶ Annullare l'operazione premendo il tasto .
- ▶ Per salvare la modifica premere il pulsante: .

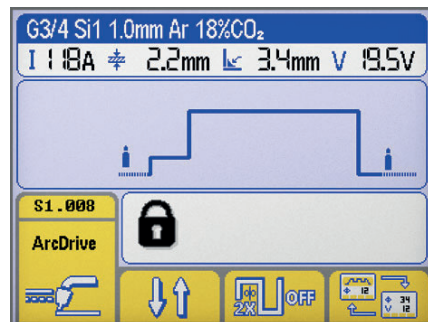

Funzioni pannello



L'esecuzione di qualsiasi operazione su un pannello comandi bloccato provoca la comparsa di una speciale schermata.

- ▶ Accedere temporaneamente (5 minuti) alle funzionalità del pannello ruotando l'encoder ed inserendo il corretto codice numerico.
- ▶ Confermare l'operazione premendo il tasto-encoder.
- ▶ Sbloccare definitivamente il pannello comandi entrando nel set up (seguire le indicazioni precedentemente descritte) e riportare il parametro 551 a "off".
- ▶ Confermare l'operazione premendo il tasto-encoder.
- ▶ Per salvare la modifica premere il pulsante: .

5.2.4 Gestione comandi esterni (Set up 602)

Permette la gestione del parametro esterno 2 (valore minimo, valore massimo, valore di default, parametro selezionato).



Selezione parametro

- ▶ Entrare nel set up premendo il tasto encoder per almeno 5 secondi.
- ▶ Selezionare il parametro desiderato (602).
- ▶ Entrare nella schermata "Gestione comandi esterni" premendo il tasto encoder.

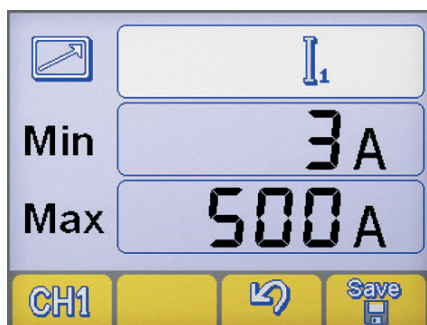

Gestione comandi esterni

- ▶ Selezionare l'uscita di controllo RC desiderata (CH1, CH2, CH3, CH4) premendo il tasto **CH1**.
- ▶ Selezionare il parametro desiderato (Min-Max-parametro) premendo il tasto encoder.
- ▶ Regolare il parametro desiderato (Min-Max-parametro) ruotando l'encoder.
- ▶ Per salvare la modifica premere il pulsante: **Save**.
- ▶ Annullare l'operazione premendo il tasto **Esc**.

5.2.5 Taratura resistenza circuito (set up 705)

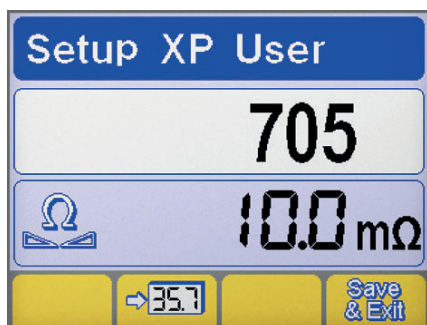

Selezione parametro

- ▶ Entrare nel set up premendo il tasto encoder per almeno 5 secondi.
- ▶ Selezionare il parametro desiderato (705).
- ▶ Attivare la regolazione del parametro selezionato premendo il tasto encoder.

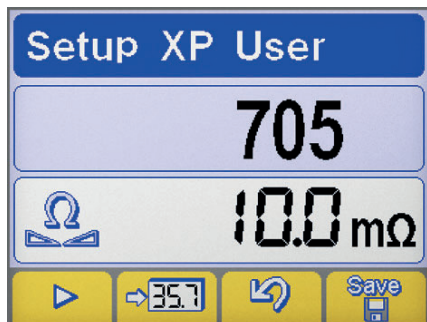

Taratura

- ▶ Mettere in contatto elettrico l'elettrodo in tungsteno ed il pezzo da saldare. (TIG)
- ▶ Mettere in contatto la torcia portaelettrodo ed il pezzo da saldare. (MMA)
- ▶ Premere il pulsante **▶** (o il pulsante torcia) per iniziare la procedura.
- ▶ Tenere il contatto per almeno un secondo.
- ▶ Il valore visualizzato a display si aggiornerà a taratura eseguita.
- ▶ Confermare l'operazione premendo il tasto **Save**.
- ▶ Annullare l'operazione premendo il tasto **Esc**.
- ▶ Per salvare la modifica ed uscire dal set up premere il tasto: **Save & Exit**.

5.2.6 Limiti di guardia (Set up 801)

Permette l'impostazione dei limiti di attenzione e dei limiti di guardia.

Permette di controllare il processo di saldatura impostando sui principali parametri misurabili limiti di attenzione e limiti di guardia.

Consente il controllo accurato delle varie fasi di saldatura.

Consultare la sezione "Limiti di guardia (Set up 801)".



I₁ Corrente di saldatura

V Tensione di saldatura

T_g Lettura di portata gas

V_g Velocità di spostamento robot



Letture di corrente (motore 1)



Letture di corrente (motore 2)



Letture flusso liquido refrigerante



Letture velocità filo



Letture di temperatura liquido refrigerante

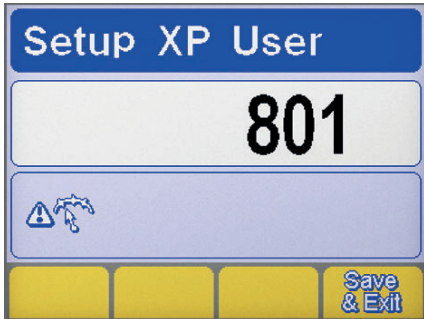

Selezione parametro

- ▶ Entrare nel set up premendo il tasto encoder per almeno 5 secondi.
- ▶ Selezionare il parametro desiderato (801).
- ▶ Entrare nella schermata "Limiti di guardia" premendo il tasto encoder.

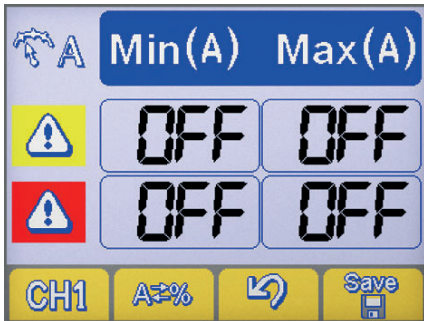

Selezione del parametro

- ▶ Selezionare il parametro desiderato premendo il tasto **CH1**.
- ▶ Selezionare la modalità d'impostazione dei limiti di guardia premendo il tasto **A=%**.



Selezione modalità



Valore assoluto



Valore percentuale

Impostazione limiti di guardia

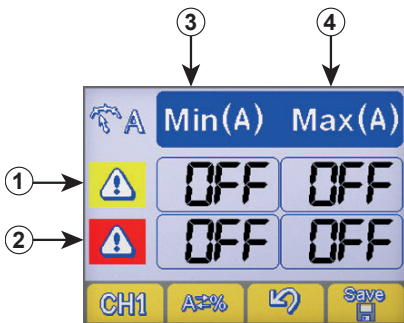

- 1 Riga dei limiti di attenzione
- 2 Riga dei limiti di allarme
- 3 Colonna dei livelli minimi
- 4 Colonna dei livelli massimi

- ▶ Selezionare la casella desiderata premendo il tasto encoder (la casella selezionata viene visualizzata con contrasto invertito).
- ▶ Regolare il livello del limite selezionato ruotando l'encoder.
- ▶ Per salvare la modifica premere il pulsante: **Save**.



Il superamento di uno dei limiti di attenzione causa una segnalazione visiva sul pannello comandi.



Il superamento di uno dei limiti di allarme causa una segnalazione visiva sul pannello comandi e il blocco immediato delle operazioni di saldatura.



È consentito impostare dei filtri di inizio e fine saldatura per evitare segnalazioni di errore nelle fasi di innesco e di chiusura dell'arco (consultare sezione "Set up" - Parametri 802-803-804).

6. MANUTENZIONE



L'impianto deve essere sottoposto ad una manutenzione ordinaria secondo le indicazioni del costruttore. Tutti gli sportelli di accesso e servizio e i coperchi devono essere chiusi e ben fissati quando l'apparecchio è in funzione. L'impianto non deve essere sottoposto ad alcun tipo di modifica. Evitare che si accumuli polvere metallica in prossimità e sulle alette di areazione.



L'eventuale manutenzione deve essere eseguita esclusivamente da personale qualificato. La riparazione o la sostituzione di parti dell'impianto da parte di personale non autorizzato comporta l'immediata invalidazione della garanzia del prodotto. L'eventuale riparazione o sostituzione di parti dell'impianto deve essere eseguita esclusivamente da personale tecnico qualificato.



Togliere l'alimentazione all'impianto prima di ogni intervento!

6.1 Controlli periodici

6.1.1 Impianto



Effettuare la pulizia interna utilizzando aria compressa a bassa pressione e pennelli a setola morbida. Controllare le connessioni elettriche e tutti i cavi di collegamento.

6.1.2 Per la manutenzione o la sostituzione dei componenti delle torce, della pinza portaelettrodo e/o del cavo massa:



Controllare la temperatura dei componenti ed accertarsi che non siano surriscaldati.



Utilizzare sempre guanti a normativa.



Utilizzare chiavi ed attrezzi adeguati.

6.2 Responsabilità



In mancanza di detta manutenzione, decadranno tutte le garanzie e comunque il costruttore viene sollevato da qualsiasi responsabilità. Nel caso l'operatore non si attenesse a quanto descritto, il costruttore declina ogni responsabilità. Per ogni dubbio e/o problema non esitare a consultare il più vicino centro di assistenza tecnica.

7. CODIFICA ALLARMI



ALLARME

L'intervento di un allarme o il superamento di un limite di guardia critico causa una segnalazione visiva sul pannello comandi ed il blocco immediato delle operazioni di saldatura.































ATTENZIONE

Il superamento di un limite di guardia causa una segnalazione visiva sul pannello comandi ma consente di continuare le operazioni di saldatura.

Di seguito sono elencati tutti gli allarmi e i tutti i limiti di guardia relativi all'impianto.

	Sovratemperatura			Sovratemperatura	
	Sovratemperatura			Sovracorrente	
	Sovracorrente modulo di potenza (Boost)			Anomalia sistema di alimentazione del motore trainafilo	

E08	Motore bloccato		E10	Sovracorrente modulo di potenza (Inverter)	
E11	Errore configurazione impianto		E13	Errore di comunicazione (FP)	
E14.xx	Programma non valido il sotto codice dell'errore indica il numero del job eliminato		E15	Programma non valido	
E16	Errore di comunicazione (RI) (automazione e robotica)		E18.xx	Programma non valido il sotto codice dell'errore indica il numero del job eliminato	
E19	Errore configurazione impianto		E20	Memoria guasta	
E21	Perdita dati		E22	Errore di comunicazione (DSP)	
E27	Memoria guasta (RTC)		E29	Misure incompatibili	
E30	Errore di comunicazione (H.F.)		E32	Perdita dati	
E33	Errore configurazione impianto (LCD 3.5")		E38	Sottotensione	
E39	Anomalia alimentazione impianto		E40	Anomalia alimentazione impianto	
E41	Sovratensione		E42	Sottotensione	
E43	Mancanza liquido refrigerante		E49	Interruttore di emergenza (automazione e robotica)	
E51	Impostazioni non supportate (automazione e robotica)		E52	Anti-collisione (automazione e robotica)	
E53	Errore flussostato esterno (automazione e robotica)		E54	Livello di corrente superato (Limite inferiore)	
E55	Livello di corrente superato (Limite superiore)		E56	Livello di tensione superato (Limite inferiore)	
E57	Livello di tensione superato (Limite superiore)		E58	Livello di flusso gas superato (Limite inferiore)	
E59	Livello di flusso gas superato (Limite superiore)		E62	Livello di corrente superato (Limite inferiore)	

 E63	Livello di corrente superato (Limite superiore)	A ↑	 E64	Livello di tensione superato (Limite inferiore)	V ↓
 E65	Livello di tensione superato (Limite superiore)	V ↑	 E66	Livello di flusso gas superato (Limite inferiore)	
 E67	Livello di flusso gas superato (Limite superiore)		 E71	Sovratemperatura liquido refrigerante	
 E72	Sovracorrente motore push-pull		 E73	Limite velocità filo superato (speed meter)	
 E75	Livello di corrente motore 2 superato	A φ	 E76	Livello di flusso liquido refrigerante superato	
 E77	Livello di temperatura liquido refrigerante		 E78	Manutenzione attiva (automazione e robotica)	
 E81	Sovracorrente (pompa WU)		 E82	Errore di comunicazione (WU)	
 E83	Pompa bloccata		 E99	Allarme generale	

8. DIAGNOSTICA E SOLUZIONI

Mancata accensione dell'impianto (led verde spento)

Causa

- » Tensione di rete non presente sulla presa di alimentazione.
- » Spina o cavo di alimentazione difettoso.
- » Fusibile di linea bruciato.
- » Interruttore di accensione difettoso.
- » Elettronica difettosa.

Soluzione

- » Eseguire una verifica e procedere alla riparazione dell'impianto elettrico.
- » Rivolgersi a personale specializzato.
- » Sostituire il componente danneggiato.
- » Rivolgersi al più vicino centro di assistenza per la riparazione dell'impianto.
- » Sostituire il componente danneggiato.
- » Sostituire il componente danneggiato.
- » Rivolgersi al più vicino centro di assistenza per la riparazione dell'impianto.
- » Rivolgersi al più vicino centro di assistenza per la riparazione dell'impianto.

Assenza di potenza in uscita (l'impianto non salda)

Causa

- » Pulsante torcia difettoso.
- » Impianto surriscaldato (allarme termico - led giallo acceso).
- » Collegamento di massa non corretto.
- » Tensione di rete fuori range (led giallo acceso).

Soluzione

- » Sostituire il componente danneggiato.
- » Rivolgersi al più vicino centro di assistenza per la riparazione dell'impianto.
- » Attendere il raffreddamento dell'impianto senza spegnere l'impianto.
- » Eseguire il corretto collegamento di massa.
- » Consultare il capitolo "Messa in servizio".
- » Riportare la tensione di rete entro il range di alimentazione del generatore.
- » Eseguire il corretto allacciamento dell'impianto.
- » Consultare il capitolo "Allacciamento".

» Teleruttore difettoso.

» Sostituire il componente danneggiato.

» Rivolgersi al più vicino centro di assistenza per la riparazione dell'impianto.

» Elettronica difettosa.

» Rivolgersi al più vicino centro di assistenza per la riparazione dell'impianto.

Erogazione di potenza non corretta

Causa

» Errata selezione del processo di saldatura o selettore difettoso.

Soluzione

» Eseguire la corretta selezione del processo di saldatura.

» Errate impostazioni dei parametri e delle funzioni dell'impianto.

» Eseguire un reset dell'impianto e reimpostare i parametri di saldatura.

» Potenziometro/encoder per la regolazione della corrente di saldatura difettoso.

» Sostituire il componente danneggiato.

» Rivolgersi al più vicino centro di assistenza per la riparazione dell'impianto.

» Tensione di rete fuori range.

» Eseguire il corretto allacciamento dell'impianto.

» Consultare il capitolo "Allacciamento".

» Mancanza di una fase.

» Eseguire il corretto allacciamento dell'impianto.

» Consultare il capitolo "Allacciamento".

» Elettronica difettosa.

» Rivolgersi al più vicino centro di assistenza per la riparazione dell'impianto.

Instabilità d'arco

Causa

» Protezione di gas insufficiente.

Soluzione

» Regolare il corretto flusso di gas.

» Verificare che diffusore e l'ugello gas della torcia siano in buone condizioni.

» Presenza di umidità nel gas di saldatura.

» Utilizzare sempre prodotti e materiali di qualità.

» Provvedere al mantenimento in perfette condizioni dell'impianto di alimentazione del gas.

» Parametri di saldatura non corretti.

» Eseguire un accurato controllo dell'impianto di saldatura.

» Rivolgersi al più vicino centro di assistenza per la riparazione dell'impianto.

Eccessiva proiezione di spruzzi

Causa

» Lunghezza d'arco non corretta.

Soluzione

» Ridurre la distanza tra elettrodo e pezzo.

» Ridurre la tensione di saldatura.

» Parametri di saldatura non corretti.

» Ridurre la corrente di saldatura.

» Protezione di gas insufficiente.

» Regolare il corretto flusso di gas.

» Verificare che diffusore e l'ugello gas della torcia siano in buone condizioni.

» Dinamica d'arco non corretta.

» Aumentare il valore induttivo del circuito.

» Modalità di esecuzione della saldatura non corretta.

» Ridurre l'inclinazione della torcia.

Insufficiente penetrazione

Causa

» Modalità di esecuzione della saldatura non corretta.

Soluzione

» Ridurre la velocità di avanzamento in saldatura.

» Parametri di saldatura non corretti.

» Aumentare la corrente di saldatura.

» Elettrodo non corretto.

» Utilizzare un elettrodo di diametro inferiore.

» Preparazione dei lembi non corretta.

» Aumentare l'apertura del cianfrino.

» Collegamento di massa non corretto.

» Eseguire il corretto collegamento di massa.

» Consultare il capitolo "Messa in servizio".

» Pezzi da saldare di consistenti dimensioni.

» Aumentare la corrente di saldatura.

Inclusioni di scoria
Causa

- » Incompleta asportazione della scoria.
- » Elettrodo di diametro troppo grosso.
- » Preparazione dei lembi non corretta.
- » Modalità di esecuzione della saldatura non corretta.

Soluzione

- » Eseguire una accurata pulizia dei pezzi prima di eseguire la saldatura.
- » Utilizzare un elettrodo di diametro inferiore.
- » Aumentare l'apertura del cianfrino.
- » Ridurre la distanza tra elettrodo e pezzo.
- » Avanzare regolarmente durante tutte le fasi della saldatura.

Inclusioni di tungsteno
Causa

- » Parametri di saldatura non corretti.
- » Elettrodo non corretto.
- » Modalità di esecuzione della saldatura non corretta.

Soluzione

- » Ridurre la corrente di saldatura.
- » Utilizzare un elettrodo di diametro superiore.
- » Utilizzare sempre prodotti e materiali di qualità.
- » Eseguire una corretta affilatura dell'elettrodo.
- » Evitare contatti tra elettrodo e bagno di saldatura.

Soffiature
Causa

- » Protezione di gas insufficiente.

Soluzione

- » Regolare il corretto flusso di gas.
- » Verificare che diffusore e l'ugello gas della torcia siano in buone condizioni.

Incollature
Causa

- » Lunghezza d'arco non corretta.
- » Parametri di saldatura non corretti.
- » Modalità di esecuzione della saldatura non corretta.
- » Pezzi da saldare di consistenti dimensioni.
- » Dinamica d'arco non corretta.

Soluzione

- » Aumentare la distanza tra elettrodo e pezzo.
- » Aumentare la tensione di saldatura.
- » Aumentare la corrente di saldatura.
- » Aumentare la tensione di saldatura.
- » Angolare maggiormente l'inclinazione della torcia.
- » Aumentare la corrente di saldatura.
- » Aumentare la tensione di saldatura.
- » Aumentare il valore induttivo del circuito.

Incisioni marginali
Causa

- » Parametri di saldatura non corretti.
- » Lunghezza d'arco non corretta.
- » Modalità di esecuzione della saldatura non corretta.
- » Protezione di gas insufficiente.

Soluzione

- » Ridurre la corrente di saldatura.
- » Utilizzare un elettrodo di diametro inferiore.
- » Ridurre la distanza tra elettrodo e pezzo.
- » Ridurre la tensione di saldatura.
- » Ridurre la velocità di oscillazione laterale nel riempimento.
- » Ridurre la velocità di avanzamento in saldatura.
- » Utilizzare gas adatti ai materiali da saldare.

Ossidazioni
Causa

- » Protezione di gas insufficiente.

Soluzione

- » Regolare il corretto flusso di gas.
- » Verificare che diffusore e l'ugello gas della torcia siano in buone condizioni.

Porosità**Causa**

- » Presenza di grasso, vernice, ruggine o sporcizia sui pezzi da saldare.
- » Presenza di grasso, vernice, ruggine o sporcizia sul materiale d'apporto.
- » Presenza di umidità nel materiale d'apporto.
- » Lunghezza d'arco non corretta.
- » Presenza di umidità nel gas di saldatura.
- » Protezione di gas insufficiente.
- » Solidificazione del bagno di saldatura troppo rapida.

Soluzione

- » Eseguire una accurata pulizia dei pezzi prima di eseguire la saldatura.
- » Utilizzare sempre prodotti e materiali di qualità.
- » Mantenere sempre in perfette condizioni il materiale d'apporto.
- » Utilizzare sempre prodotti e materiali di qualità.
- » Mantenere sempre in perfette condizioni il materiale d'apporto.
- » Ridurre la distanza tra elettrodo e pezzo.
- » Ridurre la tensione di saldatura.
- » Utilizzare sempre prodotti e materiali di qualità.
- » Provvedere al mantenimento in perfette condizioni dell'impianto di alimentazione del gas.
- » Regolare il corretto flusso di gas.
- » Verificare che diffusore e l'ugello gas della torcia siano in buone condizioni.
- » Ridurre la velocità di avanzamento in saldatura.
- » Eseguire un preriscaldamento dei pezzi da saldare.
- » Aumentare la corrente di saldatura.

Cricche a caldo**Causa**

- » Parametri di saldatura non corretti.
- » Presenza di grasso, vernice, ruggine o sporcizia sui pezzi da saldare.
- » Presenza di grasso, vernice, ruggine o sporcizia sul materiale d'apporto.
- » Modalità di esecuzione della saldatura non corretta.
- » Pezzi da saldare con caratteristiche dissimili.

Soluzione

- » Ridurre la corrente di saldatura.
- » Utilizzare un elettrodo di diametro inferiore.
- » Eseguire una accurata pulizia dei pezzi prima di eseguire la saldatura.
- » Utilizzare sempre prodotti e materiali di qualità.
- » Mantenere sempre in perfette condizioni il materiale d'apporto.
- » Eseguire le corrette sequenze operative per il tipo di giunto da saldare.
- » Eseguire una imburatura prima di realizzare la saldatura.

Cricche a freddo**Causa**

- » Presenza di umidità nel materiale d'apporto.
- » Geometria particolare del giunto da saldare.

Soluzione

- » Utilizzare sempre prodotti e materiali di qualità.
- » Mantenere sempre in perfette condizioni il materiale d'apporto.
- » Eseguire un preriscaldamento dei pezzi da saldare.
- » Eseguire un postriscaldamento.
- » Eseguire le corrette sequenze operative per il tipo di giunto da saldare.

9. ISTRUZIONI OPERATIVE

9.1 Saldatura con elettrodo rivestito (MMA)

Preparazione dei lembi

Per ottenere buone saldature è sempre consigliabile operare su parti pulite, libere da ossido, ruggine o altri agenti contaminanti.

Scelta dell'elettrodo

Il diametro dell'elettrodo da impiegare dipende dallo spessore del materiale, dalla posizione, dal tipo di giunto e dal tipo di cianfrino.

Elettrodi di grosso diametro richiedono correnti elevate con conseguente elevato apporto termico nella saldatura.

Tipo di rivestimento	Proprietà	Impiego
Rutilo	Facilità d'impiego	Tutte le posizioni
Acido	Alta velocità fusione	Piano
Basico	Caratt. meccaniche	Tutte le posizioni

Scelta della corrente di saldatura

Il range della corrente di saldatura relativa al tipo di elettrodo impiegato viene specificato dal costruttore sul contenitore stesso degli elettrodi.

Accensione e mantenimento dell'arco

L'arco elettrico si stabilisce sfregando la punta dell'elettrodo sul pezzo da saldare collegato al cavo massa e, una volta scoccato l'arco, ritraendo rapidamente la bacchetta fino alla distanza di normale saldatura.

Per migliorare l'accensione dell'arco è utile, in generale, un incremento iniziale di corrente rispetto alla corrente base di saldatura (Hot Start).

Una volta instauratosi l'arco elettrico inizia la fusione della parte centrale dell'elettrodo che si deposita sotto forma di gocce sul pezzo da saldare.

Il rivestimento esterno dell'elettrodo fornisce, consumandosi, il gas protettivo per la saldatura che risulta così di buona qualità.

Per evitare che le gocce di materiale fuso, cortocircuitando l'elettrodo col bagno di saldatura, a causa di un accidentale avvicinamento tra i due, provochino lo spegnimento dell'arco è molto utile un momentaneo aumento della corrente di saldatura fino al termine del cortocircuito (Arc Force).

Nel caso in cui l'elettrodo rimanga incollato al pezzo da saldare è utile ridurre al minimo la corrente di cortocircuito (anti-sticking).

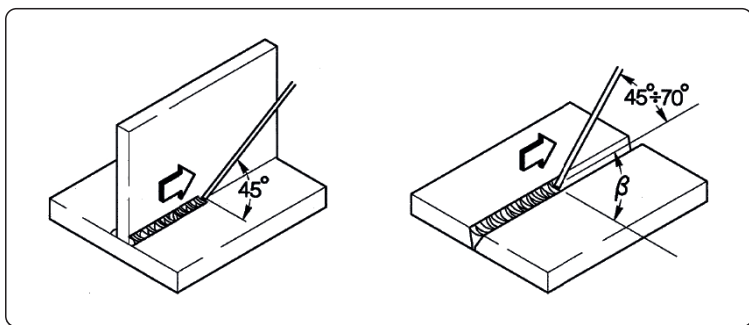

Esecuzione della saldatura

L'angolo di inclinazione dell'elettrodo varia a seconda del numero delle passate, il movimento dell'elettrodo viene eseguito normalmente con oscillazioni e fermate ai lati del cordone in modo da evitare un accumulo eccessivo di materiale d'apporto al centro.

Asportazione della scoria

La saldatura mediante elettrodi rivestiti impone l'asportazione della scoria successivamente ad ogni passata.

L'asportazione viene effettuata mediante un piccolo martello o attraverso la spazzolatura nel caso di scoria friabile.

9.2 Saldatura TIG (arco continuo)

Descrizione

Il procedimento di saldatura TIG (Tungsten Inert Gas) basa i suoi principi su di un arco elettrico che scocca tra un elettrodo infusibile (tungsteno puro o legato, avente temperatura di fusione a circa 3370°C) ed il pezzo; una atmosfera di gas inerte (Argon) provvede alla protezione del bagno.

Per evitare pericolose inclusioni di tungsteno nel giunto l'elettrodo non deve mai venire a contatto con il pezzo da saldare, per questo motivo si crea tramite un generatore H.F. una scarica che permette l'innesco a distanza dell'arco elettrico.

Esiste anche un altro tipo di partenza, con inclusioni di tungsteno ridotte: la partenza in lift, che non prevede alta frequenza ma una situazione iniziale di corto circuito a bassa corrente tra l'elettrodo e il pezzo; nel momento in cui si solleva l'elettrodo si instaura l'arco e la corrente aumenta fino al valore di saldatura impostato.

Per migliorare la qualità della parte finale del cordone di saldatura è utile poter controllare con precisione la discesa della corrente di saldatura ed è necessario che il gas fluisca nel bagno di saldatura per alcuni secondi dopo l'estinzione dell'arco.

In molte condizioni operative è utile poter disporre di 2 correnti di saldatura preimpostate e di poter passare facilmente da una all'altra (BILEVEL).

Polarità di saldatura

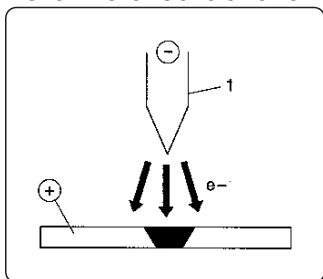

D.C.S.P. (Direct Current Straight Polarity)

È la polarità più usata (polarità diretta), consente una limitata usura dell'elettrodo in quanto il 70% del calore si concentra sull'anodo (pezzo).

Si ottengono bagni stretti e profondi con elevate velocità di avanzamento e, conseguentemente, basso apporto termico.

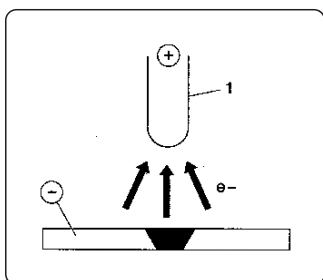

D.C.R.P. (Direct Current Reverse Polarity)

La polarità è inversa e consente la saldatura di leghe ricoperte da uno strato di ossido refrattario con temperatura di fusione superiore a quella del metallo.

Non si possono usare elevate correnti in quanto provocherebbero una elevata usura dell'elettrodo.

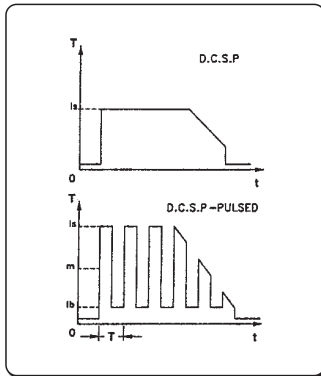

D.C.S.P.-Pulsed (Direct Current Straight Polarity Pulsed)

L'adozione di una corrente continua pulsata permette un miglior controllo del bagno di saldatura in particolari condizioni operative.

Il bagno di saldatura viene formato dagli impulsi di picco (I_p), mentre la corrente di base (I_b) mantiene l'arco acceso; questo facilita la saldatura di piccoli spessori con minori deformazioni, migliore fattore di forma e conseguente minor pericolo di cricche a caldo e di inclusioni gassose.

Con l'aumentare della frequenza (media frequenza) si ottiene un arco più stretto, più concentrato e più stabile ed una ulteriore maggiore qualità della saldatura di spessori sottili.

Caratteristiche delle saldature TIG

Il procedimento TIG risulta molto efficace nella saldatura degli acciai sia al carbonio che legati, per la prima passata sui tubi e nelle saldature che debbono presentare ottimo aspetto estetico.

È richiesta la polarità diretta (D.C.S.P.).

Preparazione dei lembi

Il procedimento richiede un'attenta pulizia dei lembi e una loro accurata preparazione.

Scelta e preparazione dell'elettrodo

Si consiglia l'uso di elettrodi di tungsteno toriato (2% di torio-colorazione rossa) o in alternativa elettrodi ceriati o lantaniati con i seguenti diametri:

Gamma di corrente			Elettrodo	
(DC-)	(DC+)	(AC)	Ø	α
3-20 A	-	3-20 A	0,5 mm	30°
15-80 A	-	20-30 A	1,0 mm	30-60°
70-150 A	10-20 A	30-80 A	1,6 mm	60-90°
150-250 A	15-30 A	60-130 A	2,4 mm	90-120°
250-400 A	25-40 A	100-180 A	3,2 mm	120-150°
400-500 A	40-55 A	160-240 A	4,0 mm	150-180°
500-750 A	55-80 A	190-300 A	4,8 mm	150-180°
750-1100 A	80-125 A	325-450 A	6,4 mm	150-180°

L'elettrodo va appuntito come indicato in figura.

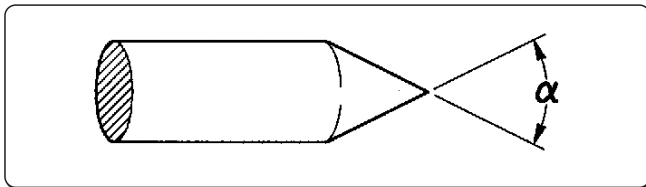

Materiale d'apporto

Le bacchette d'apporto devono possedere proprietà meccaniche paragonabili a quelle del materiale base.

È sconsigliato l'uso di strisce ricavate dal materiale base, in quanto possono contenere impurità dovute alla lavorazione, tali da compromettere le saldature.

Gas di protezione

Praticamente viene usato sempre argon puro (99.99%).

Gamma di corrente			Gas	
(DC-)	(DC+)	(AC)	Ugello	Flusso
3-20 A	-	3-20 A	n° 4	5-6 l/min
15-80 A	-	20-30 A	n° 5	6-8 l/min
70-150 A	10-20 A	30-80 A	n° 6	7-10 l/min
150-250 A	15-30 A	60-130 A	n° 7	8-12 l/min
250-400 A	25-40 A	100-180 A	n° 8	10-14 l/min

Gamma di corrente			Gas	
400-500 A	40-55 A	160-240 A	n° 8	12-16 l/min
500-750 A	55-80 A	190-300 A	n° 10	15-20 l/min
750-1100 A	80-125 A	325-450 A	n° 12	20-25 l/min

10. CARATTERISTICHE TECNICHE

Caratteristiche elettriche			U.M.
Tensione di alimentazione U1 (50/60 Hz)	3x230 (±15%)	3x400 (±15%)	Vac
Zmax (@PCC) *	53	53	mΩ
Fusibile linea ritardato	25	16	A
Tipo di comunicazione	DIGITALE	DIGITALE	
Potenza massima assorbita	10.5	10.5	kVA
Potenza massima assorbita	10.1	10.1	kW
Potenza assorbita in stato inattivo	51	51	W
Fattore di potenza (PF)	0.96	0.96	
Rendimento (μ)	83	83	%
Cos φ	0.99	0.99	
Corrente massima assorbita I1max	30.8	15.3	A
Corrente effettiva I1eff	18	9	A
Gamma di regolazione	3-270	3-270	A
Tensione a vuoto Uo	80	80	Vdc
Tensione di picco Up	10.1	10.1	kV

* Questa apparecchiatura è conforme ai requisiti della normativa EN / IEC 61000-3-11.

* Questa apparecchiatura è conforme ai requisiti della normativa EN / IEC 61000-3-12 se la massima impedenza di rete ammessa al punto di interfacciamento con la rete pubblica (punto di accoppiamento comune - point of common coupling, PCC) è inferiore o uguale al valore Zmax dichiarato. Se l'apparecchiatura è connessa alla rete pubblica a bassa tensione, è responsabilità dell'installatore o dell'utilizzatore assicurarsi, con l'eventuale consultazione del gestore della rete se necessario, che l'apparecchiatura possa essere connessa.

Fattore di utilizzo	3x230V	3x400V	U.M.
Fattore di utilizzo (40°C)			
(X=35%)	270	270	A
(X=60%)	230	230	A
(X=100%)	180	180	A
Fattore di utilizzo (25°C)			
(X=80%)	270	270	A
(X=100%)	240	240	A

Caratteristiche fisiche			U.M.
Grado di protezione IP	IP23S		
Classe isolamento	H		
Dimensioni (lxwxh)	500x190x400		mm
Peso	18.8		Kg
Sezione cavo di alimentazione	4x4		mm ²
Lunghezza cavo di alimentazione	5		m
Norme di costruzione	EN IEC 60974-1/A1:2019 EN IEC 60974-3:2019 EN 60974-10/A1:2015		

11. TARGA DATI

VOESTALPINE BÖHLER WELDING SELCO S.R.L. Via Palladio, 19 - ONARA (PADOVA) - ITALY				
URANOS NX 2700 TLH		N°		
EN IEC 60974-1/A1:2019 60974-10/A1:2015 Class A	60974-3:2019			
U ₀ 80V	Up 10.1 kV			
	3A/10.0V - 270A (270A)/20.8V (20.8V)			
	X (40°C)	35%	60%	100%
U ₀ 80V	I ₂	270A (270A)	230A (230A)	180A (180A)
	U ₂	20.8V (20.8V)	19.2V (19.2V)	17.2V (17.2V)
U ₀ 80V	3A/20.0V - 270A (270A)/30.8V (30.8V)			
	X (40°C)	35%	60%	100%
	I ₂	270A (270A)	230A (230A)	180A (180A)
	U ₂	30.8V (30.8V)	29.2V (29.2V)	27.2V (27.2V)
U ₁ 400V(230V)	I _{1max} 15.3A(30.8A)	I _{1eff} 9A(18A)		
IP 23 S				

IT

12. SIGNIFICATO TARGA DATI

1		2			
3		4			
5	6				
7	9	23			
		11			
8	10	12	15	16	17
		13	15A	16A	17A
		14	15B	16B	17B
7	9	11			
		11			
8	10	12	15	16	17
		13	15A	16A	17A
		14	15B	16B	17B
18	19	20	21		
22					

- 1 Marchio di fabbricazione
- 2 Nome ed indirizzo del costruttore
- 3 Modello dell'apparecchiatura
- 4 N° di serie
- XXXXXXXXXXXX Anno di fabbricazione
- 5 Simbolo del tipo di saldatrice
- 6 Riferimento alle norme di costruzione
- 7 Simbolo del processo di saldatura
- 8 Simbolo per le saldatrici idonee a lavorare in un ambiente a rischio accresciuto di scossa elettrica
- 9 Simbolo della corrente di saldatura
- 10 Tensione nominale a vuoto
- 11 Gamma della corrente nominale di saldatura massima e minima e della corrispondente tensione convenzionale di carico
- 12 Simbolo del ciclo di intermittenza
- 13 Simbolo della corrente nominale di saldatura
- 14 Simbolo della tensione nominale di saldatura
- 15 Valori del ciclo di intermittenza
- 16 Valori del ciclo di intermittenza
- 17 Valori del ciclo di intermittenza
- 15A Valori della corrente nominale di saldatura
- 16A Valori della corrente nominale di saldatura
- 17A Valori della corrente nominale di saldatura
- 15B Valori della tensione convenzionale di carico
- 16B Valori della tensione convenzionale di carico
- 17B Valori della tensione convenzionale di carico
- 18 Simbolo per l'alimentazione
- 19 Tensione nominale d'alimentazione
- 20 Massima corrente nominale d'alimentazione
- 21 Massima corrente efficace d'alimentazione
- 22 Grado di protezione
- 23 Tensione nominale di picco

CE Dichiarazione di conformità EU
 EAC Dichiarazione di conformità EAC
 UKCA Dichiarazione di conformità UKCA

EU-KONFORMITÄTSERKLÄRUNG

Der Bauarbeiter

voestalpine Böhler Welding Selco S.r.l. - Via Palladio, 19 - 35019 Onara di Tombolo (PD) - ITALY
Tel. +39 049 9413/111 - Fax +39 049 9413/311 - www.voestalpine.com/welding

erklärt unter seiner alleinigen Verantwortung, dass das folgende Produkt:

URANOS NX 2700 TLH 55.07.042
55.07.043

den folgenden EU Richtlinien entspricht:

2014/35/EU LOW VOLTAGE DIRECTIVE

2014/30/EU EMC DIRECTIVE

2011/65/EU RoHS DIRECTIVE

2019/1784/EU EcoDesign

2009/125/EU EcoDesign

dass die folgenden harmonisierten Normen angewendet wurden:

EN IEC 60974-1/A1:2019	WELDING POWER SOURCE
EN IEC 60974-3:2019	ARC STRIKING AND STABILIZING DEVICES
EN 60974-10/A1:2015	ELECTROMAGNETIC COMPATIBILITY REQUIREMENTS

Die Dokumentation, die die Einhaltung der Richtlinien bescheinigt, wird beim oben genannten Hersteller für Inspektionen aufbewahrt.

Jede von der Firma voestalpine Böhler Welding Selco S.r.l. nicht genehmigte Änderung hebt die Gültigkeit dieser Erklärung auf.

Onara di Tombolo, 01/07/2024

voestalpine Böhler Welding Selco s.r.l.



Mirco Frasson Ivo Bonello

Managing Directors

INDEX

1. WARNUNG	80
1.1 Arbeitsumgebung	80
1.2 Persönlicher Schutz und Schutz Dritter.....	80
1.3 Rauch- und Gasschutz.....	81
1.4 Brand-/Explosionsverhütung.....	82
1.5 Schutzmaßnahmen im Umgang mit Gasflaschen.....	82
1.6 Schutz vor Elektrischem Schlag.....	82
1.7 Elektromagnetische Felder und Störungen	82
1.8 Schutzart IP	84
1.9 Entsorgung	84
2. INSTALLATION	84
2.1 Heben, Transportieren und Abladen.....	84
2.2 Aufstellen der Anlage.....	84
2.3 Elektrischer Anschluss.....	84
2.4 Inbetriebnahme	85
3. PRÄSENTATION DER ANLAGE	86
3.1 Hintere Ansicht.....	86
3.2 Front Anschluss Ansicht.....	86
3.3 Frontbedienfeld.....	87
4. VERWENDUNG VON GERÄTEN	88
4.1 Startbildschirm	88
4.2 Haupt-Menü	88
4.3 Haupt Anzeige des E-Handsweißprozesses (MMA).....	88
5. SETUP	92
5.1 Setup und Parametereinstellung.....	92
5.2 Spezielle Verfahren zur Verwendung der Parameter	99
6. WARTUNG	103
6.1 Führen Sie folgende regelmäßige Überprüfungen am Generator durch	103
6.2 Verantwortung.....	103
7. ALARMCODES	104
8. FEHLERSUCHE	106
9. BETRIEBSANWEISUNGEN	109
9.1 Schweißen mit Mantelelektroden (E-Hand-Schweißen)	109
9.2 WIG-Schweißen (kontinuierlicher Lichtbogen).....	110
10. TECHNISCHE DATEN	112
11. DATENSCHILD	113
12. BEDEUTUNG DER ANGABEN AUF DEM LEISTUNGSSCHILD	113
13. SCHALTPLAN	438
14. VERBINDER	440
15. ERSATZTEILVERZEICHNIS	441

SYMBOLE



Warnung



Verbote



Verpflichtungen



Allgemeine Hinweise

1. WARNUNG

DE



Vor Arbeitsbeginn lesen Sie das Anleitsheft sorgfältig durch und vergewissern Sie sich, ob Sie alles richtig verstanden haben.

Nehmen Sie keine Änderungen vor und führen Sie keine hier nicht beschriebenen Instandhaltungsarbeiten durch. Der Hersteller haftet nicht für Personen- oder Sachschäden, die durch unsachgemäßen Gebrauch oder Nichteinhaltung der Vorgaben dieser Anleitung seitens des Benutzers verursacht werden.

Die Bedienungsanleitung ist ständig am Einsatzort des Gerätes aufzubewahren. Ergänzend zur Bedienungsanleitung sind die allgemein gültigen sowie die örtlichen Regeln zu Unfallverhütung und Umweltschutz zu beachten.

Die Firma **voestalpine Böhler Welding Selco S.r.l.** behält sich das Recht vor, jederzeit und ohne Vorankündigung Änderungen in dieser Anleitung vorzunehmen.

Die Übersetzungen, Nachdruck und Bearbeitungsrechte liegen bei der Firma **voestalpine Böhler Welding Selco S.r.l.** und Reproduktionen ohne schriftliche Genehmigung seitens der Firma **voestalpine Böhler Welding Selco S.r.l.** sind in jeglicher Form (einschließlich Fotokopien, Filme und Mikrofilme) komplett oder auszugsweise verboten.

Die hier aufgeführten Vorschriften sind von grundlegender Bedeutung und notwendig, um den Garantieanspruch zu sichern.

Im Fall von unsachgemäßem Gebrauch oder Nichteinhaltung der Vorschriften seitens des Benutzers, lehnt der Hersteller jegliche Haftung ab.



Alle Personen, die mit der Inbetriebnahme, Bedienung, Wartung und Instandhaltung des Gerätes zu tun haben, müssen:

- entsprechend qualifiziert sein
- Kenntnisse vom Schweißen haben
- diese Bedienungsanleitung vollständig lesen und genau befolgen

Bei Fragen oder Unklarheiten im Umgang mit dem Gerät wenden Sie sich an Fachpersonal.

1.1 Arbeitsumgebung



Die gesamte Anlage darf ausschließlich für den Zweck verwendet werden, für den sie konzipiert wurde, auf die Art und in dem Umfang, der auf dem Leistungsschild und/oder im vorliegenden Handbuch festgelegt ist und gemäß den nationalen und internationalen Sicherheitsvorschriften. Ein anderer Verwendungszweck, als der ausdrücklich vom Hersteller angegebene, ist unsachgemäß und gefährlich. Der Hersteller übernimmt in solchen Fällen keinerlei Haftung.



Dieses Gerät darf nur für gewerbliche Zwecke im industriellen Umfeld angewendet werden. Der Hersteller haftet nicht für Schäden, die durch den Gebrauch der Anlage im Haushalt verursacht wurden.



Die Anlage darf nur bei Umgebungstemperaturen zwischen -10°C und +40°C (zwischen +14°F und +104°F) benutzt werden.

Die Anlage darf nur bei Umgebungstemperaturen zwischen -25°C und +55°C (zwischen -13°F und 131°F) befördert und gelagert werden.

Die Anlage darf nur in einer Umgebung benutzt werden, die frei von Staub, Säure, Gas und ätzenden Substanzen ist.

Die Anlage darf nicht in einer Umgebung mit einer relativen Luftfeuchte über 50% bei 40°C (104°F) benutzt werden.

Die Anlage darf nicht in einer Umgebung mit einer relativen Luftfeuchte über 90% bei 20°C (68°F) benutzt werden.

Die Anlage darf nicht in einer Höhe von mehr als 2000m über NN (6500 Fuß) benutzt werden.



Verwenden Sie das Gerät nicht, um Rohre aufzutauen.

Verwenden Sie das Gerät nicht, um Batterien und/oder Akkus aufzuladen.

Verwenden Sie das Gerät nicht, um Starthilfe an Motoren zu geben.

1.2 Persönlicher Schutz und Schutz Dritter



Der Schweißvorgang verursacht schädliche Strahlungs-, Lärm-, Hitze- und Gasemissionen. Erstellen Sie eine feuerfeste Trennwand, um den Schweißbereich vor Strahlen, Funken und leichter Schlacke zu schützen. Anwesende dritte Personen darauf hinweisen, nicht in den Schweißlichtbogen oder das glühende Metall zu schauen und sich ausreichend zu schützen.



Schutzkleidung anziehen, um die Haut vor Lichtbogenstrahlung, Funken und glühend heißem Metall zu schützen. Die getragene Kleidung muss den ganzen Körper bedecken und wie folgt beschaffen sein:

- unversehrt und in gutem Zustand
- feuerfest
- isolierend und trocken
- am Körper anliegend und ohne Aufschläge



Immer normgerechtes, widerstandsfähiges und wasserfestes Schuhwerk tragen.



Immer normgerechte Handschuhe tragen, die die elektrische und thermische Isolierung gewährleisten.



Masken mit seitlichem Gesichtsschutz und geeignetem Schutzfilter (mindestens Schutzstufe 10 oder höher) für die Augen tragen.



Immer Schutzbrillen mit Seitenschutz aufsetzen, insbesondere beim manuellen oder mechanischen Entfernen der Schweißschlacke.



Keine Kontaktlinsen tragen!



Gehörschutz tragen, wenn ein gefährlicher Lärmpegel beim Schweißen erreicht wird. Wenn der Geräuschpegel die gesetzlich festgelegten Grenzwerte überschreitet, den Arbeitsbereich abgrenzen und prüfen, ob die Personen, die diesen Bereich betreten, Gehörschutz tragen.



Die Seitenpaneele beim Schweißen immer geschlossen halten. Die Anlage darf keiner Änderung unterzogen werden.



Soeben geschweißte Werkstücke nicht berühren: die Hitze kann schwere Verbrennungen verursachen.



Alle oben beschriebenen Sicherheitsvorschriften auch bei den Arbeitsschritten nach dem Schweißen berücksichtigen, da sich Zunder von den bearbeiteten und sich abkühlenden Werkstücken ablösen kann.



Sicherstellen, dass der Brenner abgekühlt ist, bevor daran Arbeiten oder Wartungen ausgeführt werden.



Sicherstellen, dass das Kühlaggregat ausgeschaltet ist, bevor die Leitungen für den Vor- und Rücklauf der Kühlflüssigkeit abgetrennt werden. Die austretende heiße Flüssigkeit kann schwere Verbrennungen verursachen.



Einen Verbandskasten griffbereit halten.
Verbrennungen oder Verletzungen sind nicht zu unterschätzen.



Vor dem Verlassen des Arbeitsplatzes muss dieser gesichert werden, um Personen- und Sachschäden zu vermeiden.

1.3 Rauch- und Gasschutz



Rauch, Gas und Staub, die durch das Schweißverfahren entstehen, können gesundheitsschädlich sein. Der beim Schweißen entstehende Rauch kann unter bestimmten Umständen Krebs oder bei Schwangeren Auswirkungen auf das Ungeborene verursachen.

- Den Kopf fern von Schweißgasen und Schweißrauch halten.
- Im Arbeitsbereich für eine angemessene natürliche Lüftung bzw. Zwangsbelüftung sorgen.
- Bei ungenügender Belüftung sind Masken mit Atemgerät zu tragen.
- Wenn Schweißarbeiten in engen Räumen durchgeführt werden, sollte der Schweißer von einem außerhalb dieses Raums stehenden Kollegen beaufsichtigt werden.
- Wichtiger Hinweis: Keinen Sauerstoff für die Lüftung verwenden.
- Die Wirksamkeit der Absaugung überprüfen, indem die abgegebene Schadgasmenge regelmäßig mit den laut Sicherheitsvorschriften zulässigen Werten verglichen wird.
- Die Menge und Gefährlichkeit des erzeugten Schweißrauchs hängt vom benutzten Grundmaterial, vom Zusatzmaterial und den Stoffen ab, die man zur Reinigung und Entfettung der Werkstücke benutzt. Die Anweisungen des Herstellers und die entsprechenden technischen Datenblätter genau befolgen.
- Keine Schweißarbeiten in der Nähe von Entfettungs- oder Lackierarbeiten durchführen.
- Die Gasflaschen nur im Freien oder in gut belüfteten Räumen aufstellen.

1.4 Brand-/Explosionsverhütung



Das Schweißverfahren kann Feuer und/oder Explosionen verursachen.

- Alle entzündlichen bzw. brennbaren Stoffe oder Gegenstände aus dem Arbeitsbereich und aus dem umliegenden Bereich entfernen.
- Entzündliches Material muss mindestens 11m (35 Fuß) vom Ort, an dem geschweißt wird, entfernt sein oder entsprechend geschützt werden.
- Sprühende Funken und glühende Teilchen können leicht verstreut werden und benachbarte Bereiche auch durch kleine Öffnungen erreichen. Seien Sie beim Schutz von Personen und Gegenständen besonders aufmerksam.
- Keine Schweiß- oder Schneidarbeiten über oder in der Nähe von Druckbehältern ausführen.
- Keine Schweiß- oder Schneidarbeiten an geschlossenen Behältern oder Rohren durchführen. Beim Schweißen von Rohren oder Behältern besonders aufmerksam sein, auch wenn diese geöffnet, entleert und sorgfältig gereinigt wurden. Rückstände von Gas, Kraftstoff, Öl oder ähnlichen Substanzen können Explosionen verursachen.
- Nicht an Orten schweißen die explosive Staubteile, Gase oder Dämpfe enthalten.
- Nach dem Schweißen sicherstellen, dass der unter Spannung stehende Kreis nicht zufällig Teile berühren kann, die mit dem Massekreis verbunden sind.
- In der Nähe des Arbeitsbereichs Feuerlöschgerät platzieren.

1.5 Schutzmaßnahmen im Umgang mit Gasflaschen



Inertgasflaschen enthalten unter Druck stehendes Gas und können explodieren, wenn das Mindestmaß an Sicherheitsanforderungen für Transport, Lagerung und Gebrauch nicht gewährleistet ist.

- Die Gasflaschen müssen senkrecht an der Wand oder in anderen dafür vorgesehenen Vorrichtungen befestigt werden, damit sie nicht umfallen oder etwas anderes beschädigen können.
- Die Schutzkappe festschrauben, um das Ventil beim Transport, der Inbetriebnahme und nach Ende eines jeden Schweißvorgangs zu schützen.
- Die Flaschen weder direkter Sonneneinstrahlung noch hohen Temperaturschwankungen aussetzen. Die Flaschen dürfen keinen allzu niedrigen oder hohen Temperaturen ausgesetzt werden.
- Die Gasflaschen dürfen nicht mit offenem Feuer, elektrischen Lichtbögen, Brennern oder Schweißzangen und nicht mit beim Schweißen verspritzten glühenden Teilchen in Berührung kommen.
- Die Gasflaschen von Schweiß- und Stromkreisen im Allgemeinen fernhalten.
- Beim Öffnen des Ventils den Kopf fern von der Auslassöffnung des Gases halten.
- Das Ventil der Gasflasche immer schließen, wenn die Schweißarbeiten beendet sind.
- Niemals Schweißarbeiten an einer unter Druck stehenden Gasflasche ausführen.
- Eine Druckgasflasche darf nie direkt an den Druckminderer des Schweißgerätes angeschlossen werden! Der Druck kann die Kapazität des Druckminderers übersteigen, welcher deswegen explodieren könnte!

1.6 Schutz vor Elektrischem Schlag



Ein Stromschlag kann tödlich sein.

- Üblicherweise unter Spannung stehende Innen- oder Außenteile der gespeisten Schweißanlage nicht berühren (Brenner, Zangen, Massekabel, Elektroden, Draht, Rollen und Spulen sind elektrisch mit dem Schweißstromkreis verbunden).
- Die elektrische Isolierung der Anlage durch Benutzung trockener und ausreichend vom Erd- und Massepotential isolierter Flächen und Untergestelle sicherstellen.
- Sicherstellen, dass die Anlage an einer Steckdose und einem Stromnetz mit Schutzleiter korrekt angeschlossen wird.
- Achtung: Nie zwei Schweißbrenner oder zwei Schweißzangen gleichzeitig berühren.
- Die Schweißarbeiten sofort abbrechen, wenn das Gefühl eines elektrischen Schlags wahrgenommen wird.



Die Lichtbogenzündungs- und Stabilisierungsvorrichtung ist für manuell oder maschinell ausgeführte Arbeitsprozesse entworfen.



Ein Verlängern der Brenner- oder Schweißkabel um mehr als 8m erhöht das Risiko eines Elektrischen Schlags.

1.7 Elektromagnetische Felder und Störungen



Der Strom, der durch die internen und externen Kabel der Anlage fließt, erzeugt in der unmittelbaren Nähe der Schweißkabel und der Anlage selbst ein elektromagnetisches Feld.

- Elektromagnetische Felder können die Gesundheit von Personen angreifen, die diesen langfristig ausgesetzt sind. (genaue Auswirkungen sind bis heute unbekannt).

- Elektromagnetische Felder können Störungen an Geräten wie Schrittmachern oder Hörgeräten verursachen.



Die Träger lebenswichtiger elektronischer Apparaturen (Schrittmacher) müssen die Genehmigung des Arztes einholen, bevor sie sich Verfahren wie Lichtbogenschweißen.

1.7.1 EMV in Übereinstimmung mit: EN 60974-10/A1:2015.



Anlagen der Klasse B entsprechen den elektromagnetischen Kompatibilitätsanforderungen in Mischgebieten, einschließlich Wohngebieten, in denen die elektrische Leistung von dem öffentlichen Niederspannungsversorgungsnetz geliefert wird.



Anlagen der Klasse A sind nicht für die Nutzung in Wohngebieten konzipiert, in denen die elektrische Leistung vom öffentlichen Niederspannungsversorgungsnetz geliefert wird. Es können potenzielle Schwierigkeiten beim Sicherstellen der elektromagnetischen Kompatibilität von Anlagen der Klasse A in diesen Umgebungen auftreten, aufgrund der ausgestrahlten Störgrößen.

Weitere Informationen finden Sie unter: DATENSCHILD oder TECHNISCHE DATEN.

1.7.2 Installation, Gebrauch und Bewertung des Bereichs

Dieses Gerät ist in Übereinstimmung mit den Angaben der harmonisierten Norm hergestellt EN 60974-10/A1:2015 und als Gerät der "KLASSE A" gekennzeichnet. Dieses Gerät darf nur für gewerbliche Zwecke im industriellen Umfeld angewendet werden. Der Hersteller haftet nicht für Schäden, die durch den Gebrauch der Anlage im Haushalt verursacht wurden.



Der Benutzer muss ein erfahrener Fachmann auf dem Gebiet sein und ist als solcher für die Installation und den Gebrauch des Geräts gemäß den Herstelleranweisungen verantwortlich. Wenn elektromagnetische Störungen festgestellt werden, muss der Benutzer des Gerätes das Problem lösen, wenn notwendig mit Hilfe des Kundendienstes des Herstellers.



In jedem Fall müssen die elektromagnetischen Störungen soweit reduziert werden, bis sie keine Belästigung mehr darstellen.



Bevor das Gerät installiert wird, muss der Benutzer die möglichen elektromagnetischen Probleme, die sich im umliegenden Bereich ergeben können, und insbesondere die Gesundheit, der sich in diesem Bereich aufhaltenden Personen - Träger von Schrittmachern und Hörgeräten - prüfen.

1.7.3 Anforderungen an die Netzversorgung

Hochleistungsanlagen können, aufgrund der Stromentnahme des Primärstroms aus der Netzversorgung, die Leistungsqualität des Netzes beeinflussen. Deshalb können Anschlussrichtlinien oder -anforderungen, unter Beachtung der maximal zulässigen Netzimpedanz (Z_{max}) oder der erforderlichen minimalen Netzkapazität (S_{sc}) an der Schnittstelle zum öffentlichen Netz (Netzübergabestelle) für einige Anlagentypen angewendet werden (siehe Technische Daten). In diesem Fall liegt es in der Verantwortung des Installateurs oder Betreibers der Anlage sicherzustellen, dass die Anlage angeschlossen werden darf, indem, falls notwendig, der Netzbetreiber konsultiert wird. Im Falle einer Störung können weitere Vorsichtsmaßnahmen notwendig sein; beispielsweise Filterung der Netzversorgung.

Es kann auch notwendig sein, das Versorgungskabel abzuschirmen.

Weitere Informationen finden Sie unter: TECHNISCHE DATEN.

1.7.4 Vorsichtsmaßnahmen für die Kabel

Um die Auswirkungen der elektromagnetischen Felder so gering wie möglich zu halten, sind folgende Maßnahmen zu treffen:

- Masse und Leistungskabel, wo möglich, zusammen verlegen und aneinander befestigen.
- Die Kabel nie um den Körper wickeln.
- Sich nicht zwischen Masse und Leistungskabel stellen (beide Kabel auf derselben Seite halten).
- Die Kabel müssen so kurz wie möglich sein, so dicht wie möglich beieinander liegen und am bzw. in der Nähe des Bodens verlaufen.
- Die Anlage in einem gewissen Abstand vom Bereich aufstellen, in dem geschweißt wird.
- Die Kabel müssen fern von anderen vorhandenen Kabeln verlegt sein.

1.7.5 Potentialausgleich

Der Erdanschluss aller Metallteile in der Schweißanlage (Schneidanlage) und in der Nähe derselben muss berücksichtigt werden. Die Vorschriften bezüglich des Potentialausgleiches beachten.

1.7.6 Erdung des Werkstücks

Wenn das Werkstück aus Gründen der elektrischen Sicherheit oder aufgrund seiner Größe und Lage nicht geerdet ist, könnte ein Erdanschluss des Werkstücks die Emissionen reduzieren. Es muss dringend beachtet werden, dass eine Erdung des Werkstücks weder die Unfallgefahr für den Bediener erhöhen noch andere elektrische Geräte beschädigen darf. Die Erdung muss gemäß den örtlichen Vorschriften erfolgen.

1.7.7 Abschirmung

Durch die selektive Abschirmung anderer Kabel und Geräte im umliegenden Bereich lassen sich die Probleme durch elektromagnetische Störungen reduzieren.

Die Abschirmung der gesamten Schweißanlage kann in besonderen Fällen in Betracht gezogen werden.

1.8 Schutzart IP



IP23S

- Gehäuse mit Schutz gegen Berührung gefährlicher Teile mit den Fingern und vor dem Eindringen von Fremdkörpern mit einem Durchmesser größer/gleich 12,5 mm.
- Gehäuse mit Schutz gegen Sprühwasser bis zu einem Winkel von 60° in Bezug auf die Senkrechte.
- Gehäuse mit Schutz gegen Schäden durch eindringendes Wasser, wenn die beweglichen Teile der Anlage im Stillstand sind.

1.9 Entsorgung



Das Elektrogerät nicht in den normalen Hausmüll geben!

Gemäß der europäischen Richtlinie 2012/19/EU über Elektro- und Elektronik-Altgeräte und der Umsetzung dieser Richtlinie in innerstaatliches Recht müssen die Geräte am Ende ihrer Nutzungsdauer getrennt gesammelt und einer Verwertungs- und Recyclingstelle zugeführt werden. Der Eigentümer des Geräts muss die autorisierten Sammelstellen durch Kontaktnahme der örtlichen Behörden in Erfahrung bringen. Durch die Einhaltung der Europäischen Richtlinie schützen Sie die Umwelt und die Gesundheit Ihrer Mitmenschen.

» Weitere Infos finden Sie auf der Website.

2. INSTALLATION



Die Installation darf nur von erfahrenem und vom Hersteller berechtigtem Personal ausgeführt werden.



Stellen Sie sicher, dass während der Installation der Generator vom Versorgungsnetz getrennt ist.



Die Zusammenschaltung mehrerer Generatoren (Reihen- oder Parallelschaltung) ist verboten.

2.1 Heben, Transportieren und Abladen

- Die Anlage ist mit einem Griff zur Beförderung von Hand versehen.



Das Gewicht der Anlage ist nicht zu unterschätzen, siehe Technische Daten.

Bewegen oder platzieren Sie die angehängte Last nicht über Personen oder Gegenständen.

Lassen Sie das Gerät/die Anlage nicht fallen und üben Sie keinen übermäßigen Druck auf die Anlage aus.

2.2 Aufstellen der Anlage



Folgende Vorschriften beachten:

- Sorgen Sie für freien Zugang zu den Bedienelementen und Anschlüssen.
- Stellen Sie die Anlage nicht in engen Räumen auf.
- Stellen Sie die Anlage nie auf einer Fläche mit einer Neigung von mehr als 10° auf.
- Stellen Sie die Anlage an einem trockenen und sauberen Ort mit ausreichender Belüftung auf.
- Schützen Sie die Anlage vor strömenden Regen und Sonne.

2.3 Elektrischer Anschluss



Der Generator ist mit einem Stromkabel für den Anschluss an das Stromnetz versehen.

Die Anlage kann gespeist werden mit:

- 230V dreiphasig
- 400V dreiphasig

Der Betrieb des Geräts wird für Spannungsabweichungen vom Nennwert bis zu ±15% garantiert.



Um Schäden an Personen oder der Anlage zu vermeiden, müssen vor dem Anschluss des Geräts an das Stromnetz die gewählte Netzspannung und die Sicherungen kontrolliert werden. Weiterhin ist sicher zu stellen, dass das Kabel an eine Steckdose mit Schutzleiterkontakt angeschlossen wird.



Die Anlage kann mit einem Generatorsatz gespeist werden. Voraussetzung ist, dass dieser unter allen möglichen Betriebsbedingungen und bei vom Generator abgegebener Höchstleistung eine stabile Versorgungsspannung gewährleistet, mit Abweichungen zum vom Hersteller erklärten Spannungswert von ±15%. Gewöhnlich wird der Gebrauch von Generatorsätzen empfohlen, deren Leistung bei einphasigem Anschluss 2mal und bei dreiphasigem Anschluss 1,5mal so groß wie die Generatorleistung ist. Der Gebrauch elektronisch gesteuerter Generatorsätze wird empfohlen.



Zum Schutz der Benutzer muss die Anlage korrekt geerdet werden. Das Versorgungskabel ist mit einem grüngelben Schutzleiter versehen, der mit einem Stecker mit Schutzleiterkontakt verbunden werden muss. Dieser grün/gelber Leiter darf ausschließlich als Schutzleiter verwendet werden. Prüfen, ob die verwendete Anlage geerdet ist und ob die Steckdose/n in einem gutem Zustand sind. Nur zugelassene Stecker montieren, die den Sicherheitsvorschriften entsprechen.



Der elektrische Anschluss muss gemäß den am Installationsort geltenden Gesetzen von qualifizierten Technikern, die eine spezifische Ausbildung nachweisen können, ausgeführt werden.

2.4 Inbetriebnahme

2.4.1 Anschluss für E-Hand-Schweißen



Der Anschluss in der Abbildung ergibt eine Schweißung mit umgekehrter Polung. Um eine Schweißung mit direkter Polung zu erhalten, muss der Anschluss umgekehrt werden.

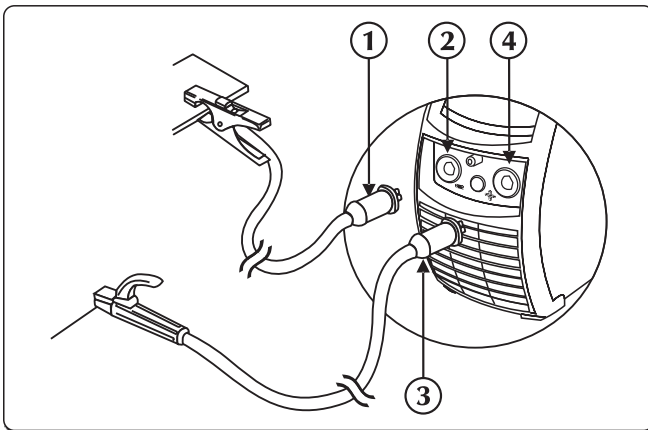

- ① Verbinder der Erdungszange
- ② Schweißstrom Anschluss (-)
- ③ Verbinder der Elektrodenhalter-Zange
- ④ Schweißstrom Anschluss (+)

- ▶ Den Verbinder der Erdungszange an die Steckdose des Minuskabels (-) des Generators anschließen. Den Stecker einstecken und im Uhrzeigersinn drehen, bis alle Teile fest sind.
- ▶ Den Verbinder der Schweißzange an die Steckdose des Pluskabels (+) des Generators anschließen. Den Stecker einstecken und im Uhrzeigersinn drehen, bis alle Teile fest sind.

2.4.2 Anschluss für WIG-Schweißen

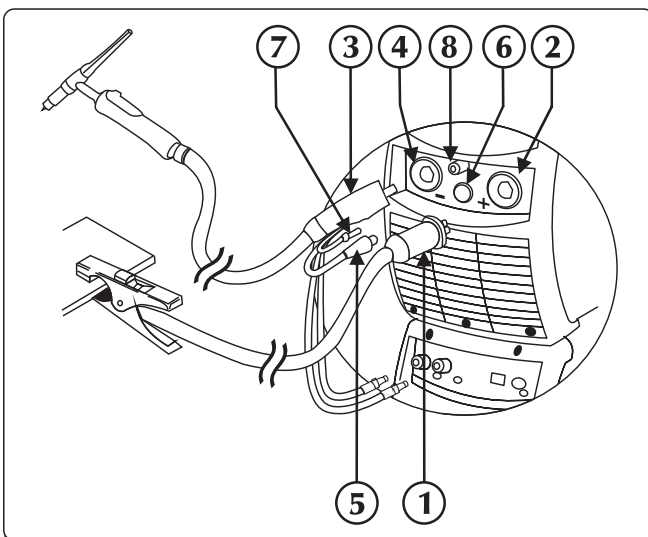

- ① Verbinder der Erdungszange
- ② Schweißstrom Anschluss (+)
- ③ WIG-Brenneranschluss
- ④ Steckdose brenner
- ⑤ Signalkabel Brenners
- ⑥ Verbinder
- ⑦ Brennergasrohr
- ⑧ Gasanschluss

- ▶ Den Verbinder der Erdungszange an die Steckdose des Pluskabels (+) des Generators anschließen. Den Stecker einstecken und im Uhrzeigersinn drehen, bis alle Teile fest sind.
- ▶ Den Anschluß der WIG-Schweißbrenner in die Steckdose der Schweißbrenner des Generators stecken. Den Stecker einstecken und im Uhrzeigersinn drehen, bis alle Teile fest sind.
- ▶ Verbinden Sie das Signalkabel des Brenners mit dem entsprechenden Anschluss.
- ▶ Verbinden Sie den Gasschlauch mit dem entsprechenden Anschluss.
- ▶ Den roten Schlauch (Rücklauf der Kühlflüssigkeit) des Brenners mit dem entsprechenden Schnellverbinder  (rot) verbinden.

► Den blauen Schlauch (Vorlauf der Kühlflüssigkeit) des Brenners mit dem entsprechenden Schnellverbinder (blau) verbinden.

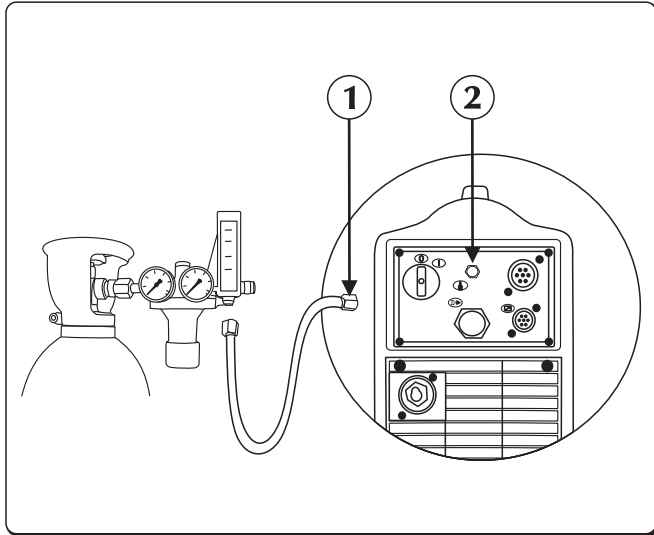

- ① Brennergas
- ② Gasanschluss

► Den Gasschlauch, der von der Gasflasche kommt, am hinteren Gasanschluss anschließen. Den Gasdurchfluss auf einen Wert zwischen 5 und 15 l/min einstellen.

3. PRÄSENTATION DER ANLAGE

3.1 Hintere Ansicht

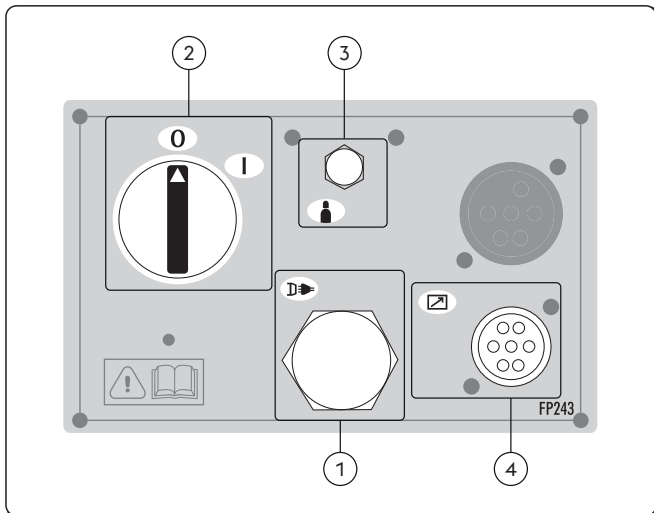

- ① Netzkabel Eingang
Für den Netzanschluss und die Speisung der Anlage.
- ② Hauptschalter
Schaltet die Anlage elektrisch ein.
Er verfügt über zwei Positionen: "0" AUS; "I" EIN.
- ③ Gasanschluss
- ④ CAN-BUS-Eingang (RC, RI...)



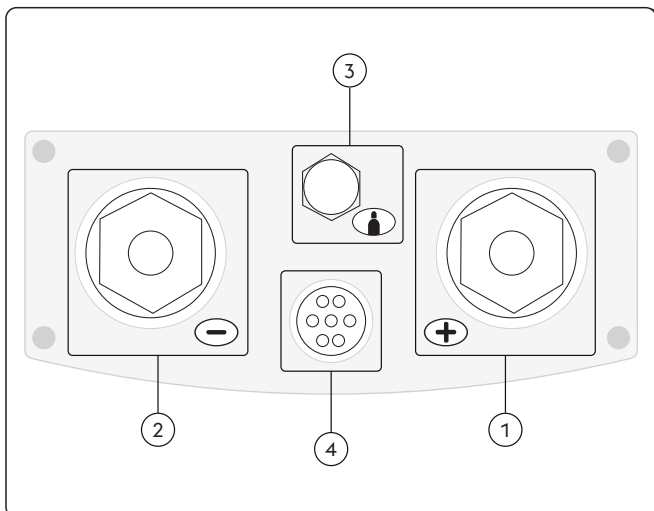



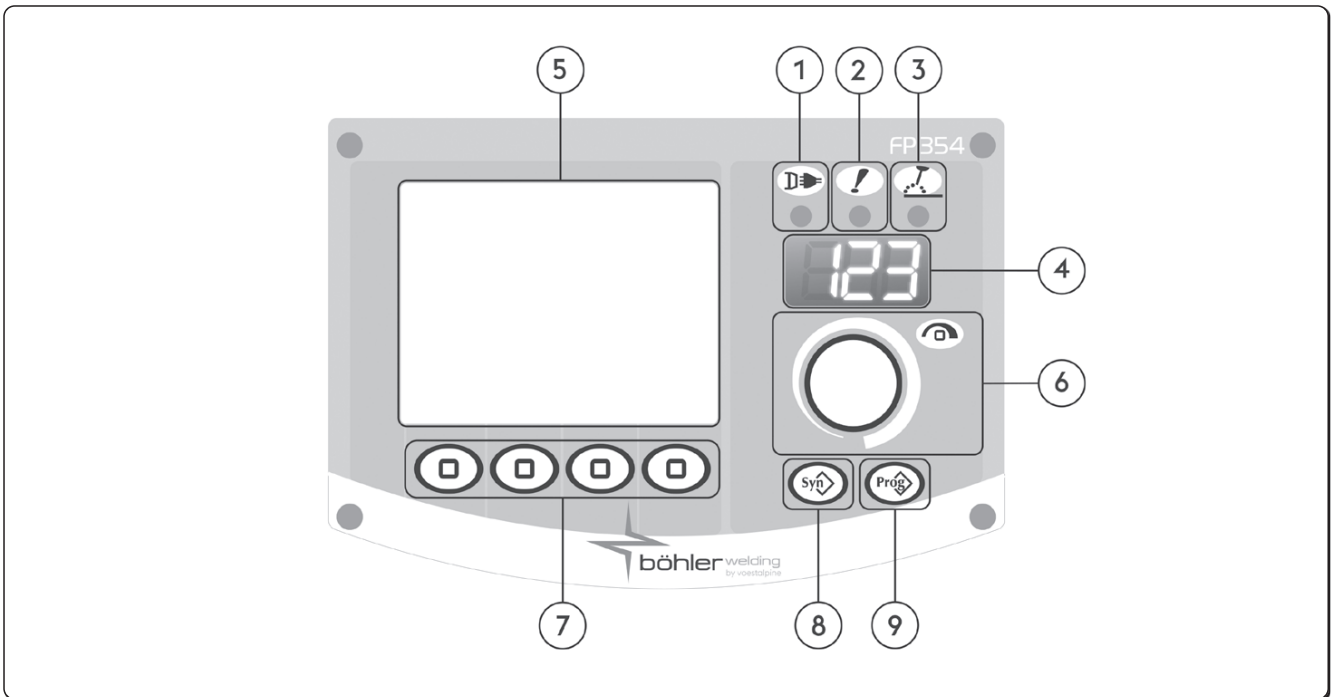

3.2 Front Anschluss Ansicht



- ① Schweißstrom Anschluss (+)
Prozess MMA: Elektrodenbrennerverbindung
Prozess WIG: Erdungskabelverbindung
- ② Schweißstrom Anschluss (-)
Prozess MMA: Erdungskabelverbindung
Prozess WIG: Brenneranschluss
- ③ Gasanschluss
- ④ Signalkabeleingang (WIG-Schweißbrenner)

3.3 Frontbedienfeld



- 1  **LED Versorgung**
Zeigt an, dass die Anlage an die Stromversorgung angeschlossen und eingeschaltet ist.
- 2  **LED Allgemeiner Alarm**
Zeigt den möglichen Eingriff von Schutzeinrichtungen an, z. B. Temperaturschutz.
- 3  **LED Aktive Leistung**
Zeigt an, dass an den Ausgangsklemmen der Anlage Spannung anliegt.
- 4  **7-Segment-Anzeige**
Ermöglicht die Anzeige allgemeiner Geräteparameter während des Startens; Ablesen von Einstellungen, Strom und Spannung während des Schweißens und die Anzeige von Fehlercodes.
- 5  **LCD Display**
Ermöglicht die Anzeige allgemeiner Geräteparameter während des Startens; Ablesen von Einstellungen, Strom und Spannung während des Schweißens und die Anzeige von Fehlercodes.
Ermöglicht die verzögerungsfreie Anzeige aller Vorgänge.
- 6  **Hauptregler**
Ermöglicht das stufenlose Einstellen des Schweißstroms.
Ermöglicht den Zugang zum Setup, die Auswahl und Einstellung der Schweißparameter.
- 7  **Funktionstasten**
Ermöglicht die Auswahl der verschiedenen Funktionen der Anlage:
- Schweißverfahren E-Hand
- Schweißmethoden
- Impulsstrom
- Grafikmodus
- 8  **Taste nicht verwendet**
- 9  **Job-Taste**
Ermöglicht das Speichern und Verwalten von 240 Job, die vom Bediener personalisiert werden können.

DE

DE

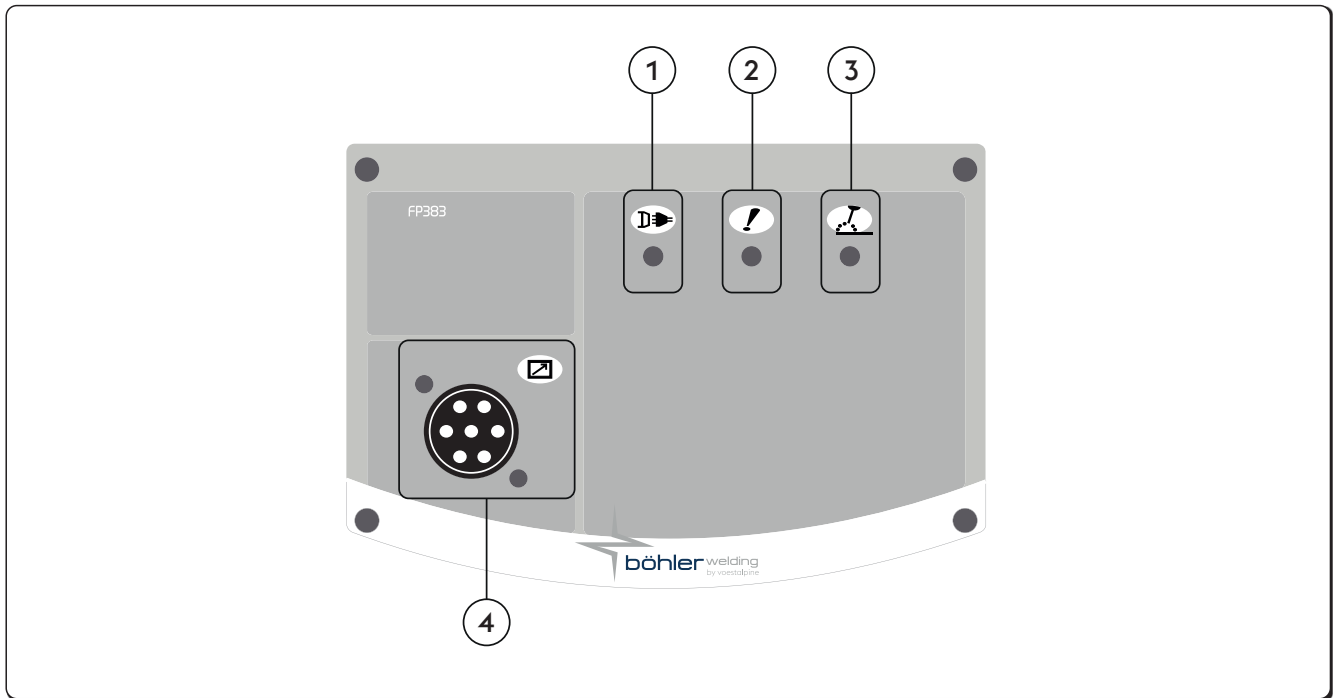

- ① **LED Versorgung**
Zeigt an, dass die Anlage an die Stromversorgung angeschlossen und eingeschaltet ist.
- ② **LED Allgemeiner Alarm**
Zeigt den möglichen Eingriff von Schutzeinrichtungen an, z. B. Temperaturschutz.
- ③ **LED Aktive Leistung**
Zeigt an, dass an den Ausgangsklemmen der Anlage Spannung anliegt.
- ④ **Eingang CAN-BUS-Signalkabel (RC, RI...)**

4. VERWENDUNG VON GERÄTEN

4.1 Startbildschirm

Beim Einschalten führt die Anlage eine Reihe von Tests aus, um die korrekte Funktion der Anlage und der daran angeschlossenen Geräte zu prüfen. An dieser Stelle wird auch der Gastest durchgeführt, um den richtigen Anschluss der Gaszufuhr zu prüfen.

4.2 Haupt-Menü

Ermöglicht die Steuerung der Anlage und des Schweißverfahrens und zeigt die Haupteinstellungen an.

4.3 Haupt Anzeige des E-Handschweißprozesses (MMA)

- ① Schweißstrom und Schweißspannungs Anzeige
- ② Schweißparameter
- ③ Funktionen

Schweißstrom und Schweißspannung Anzeige

Während der Schweißarbeiten werden der Ist-Strom und die Ist-Spannung im LCD-Display angezeigt.

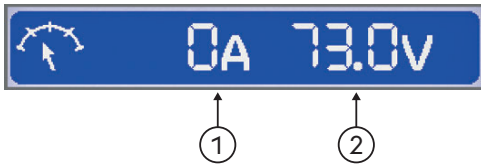

- ① Schweißstrom
- ② Schweißspannung

Schweißparameter

► Wählen Sie den gewünschten Parameter aus, indem Sie den Taster Encoder drücken.

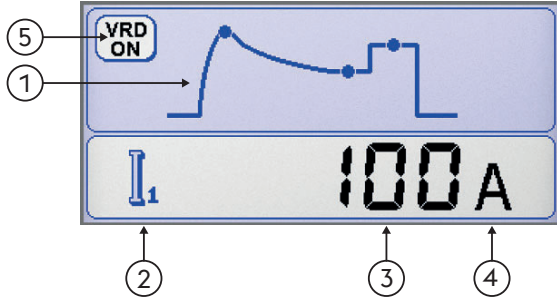

- ① Schweißparameter
- ② Symbol des Parameters
- ③ Wert des Parameters
- ④ Maßeinheit des Parameters
- ⑤ VRD (Voltage Reduction Device)
Vorrichtung für Spannungsverminderung
Zeigt an, daß die Leerlaufspannung der Anlage kontrolliert wird.

Funktionen

Ermöglicht das Einstellen der wichtigsten Funktionen des Schweißverfahrens und der Schweißmethoden.

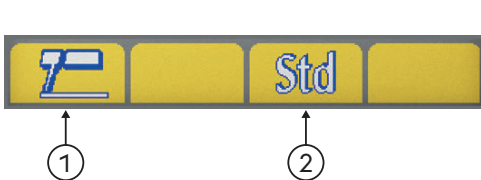

- ① Schweißverfahren
- ② E-Hand Synergie

Schweißverfahren

MMA / E-Hand → TIG DC

E-Hand Synergie

Zur Einstellung der optimalen Bogendynamik und zur Auswahl der benutzten Elektrode.
Mit der Wahl der richtigen Bogendynamik kann der maximale Nutzen des Generators erzielt werden mit der Absicht die bestmögliche Schweißleistung zu erreichen.

Standard (Basisch/Rutil) → Cellulose → CrNi → Al → Cast Iron

Perfekte Schweißfähigkeit der verwendeten Elektrode wird nicht garantiert
Die Schweißfähigkeit hängt ab von der Qualität des Verbrauchsmaterials und dessen Aufbewahrung, den Arbeits- und Schweißbedingungen, den zahlreichen Einsatzmöglichkeiten.

DE

4.4 Haupt Anzeige des WIG-Handschweißprozesses (TIG)

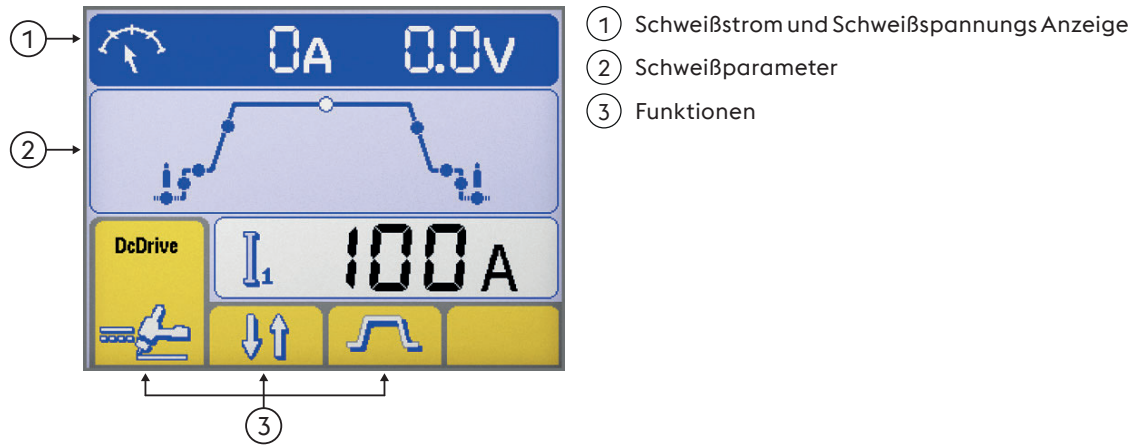

Schweißstrom und Schweißspannungs Anzeige

Während der Schweißarbeiten werden der Ist-Strom und die Ist-Spannung im LCD-Display angezeigt.

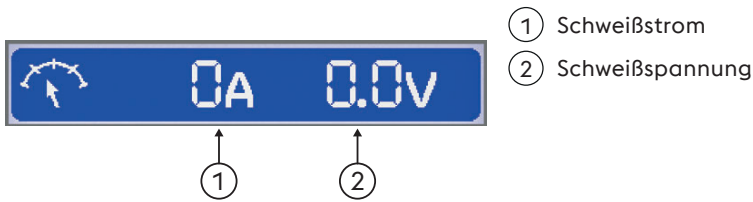

Schweißparameter

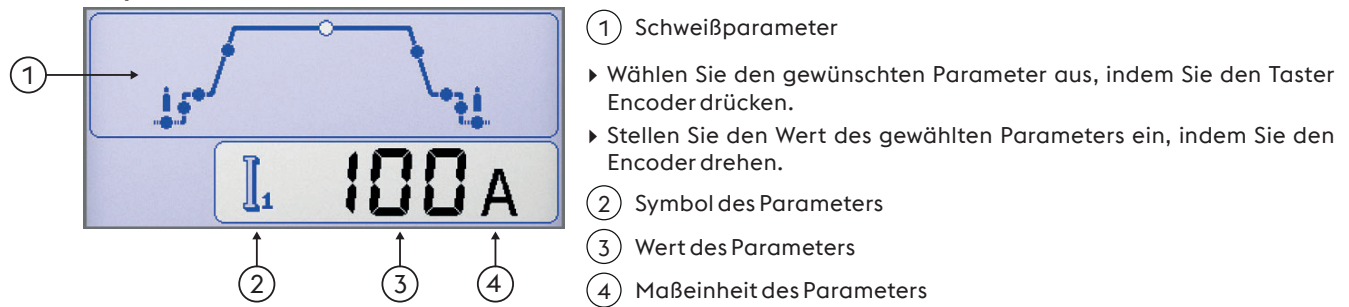

Funktionen

Ermöglicht das Einstellen der wichtigsten Funktionen des Schweißverfahrens und der Schweißmethoden.

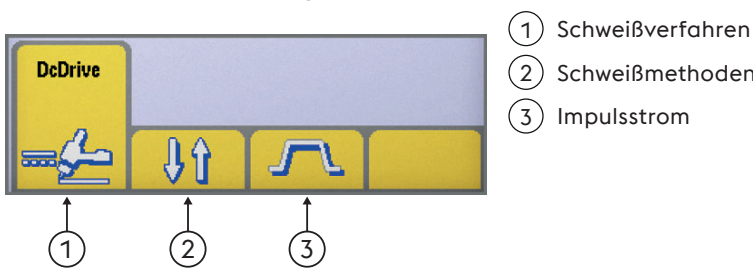

Schweißverfahren



Schweißmethoden

Ermöglicht die Auswahl der Schweißmethode

- 2-Taktbetrieb, in zwei Stufen
- 2-Taktbetrieb Durch Drücken des Tasters beginnt der Gasdurchfluss und der Lichtbogen wird gezündet. Beim Loslassen des Tasters geht der Strom in der Down-Slopezeit auf Null zurück. Wenn der Bogen erloschen ist, beginnt die Gasnachströmzeit.



4-Taktbetrieb, in vier Stufen

4-Taktbetrieb Durch das erste Drücken des Tasters beginnt der Gasdurchfluss (manuelles Gasvorströmen). Beim Loslassen des Tasters wird der Lichtbogen gezündet.



Bilevel

Im Modus Bilevel kann der Schweißer mit zwei vorab eingestellten verschiedenen Schweißströmen schweißen. Das erste Drücken des Tasters führt zur Gasvorströmzeit, zum Zünden des Lichtbogens und ermöglicht Schweißen mit Startstrom. Das erste Loslassen des Tasters führt zum Up-Slope des Stroms auf "I1". Durch kurzes Drücken und Loslassen des Tasters, wechselt der Strom zu "I2". Erneutes kurzes Drücken und Loslassen wechselt zurück auf "I1" und so weiter. Bei längerem Drücken beginnt man die Abstiegsslope des Stroms bis zum Endstrom. Beim Loslassen des Tasters erlischt der Lichtbogen und das Gas fließt für die Dauer der Gasnachströmzeit weiter.



Impulsstrom



Konstanter Strom



Impuls-strom



Fast Pulse



EasyArc

4.5 Programm-Menü



Ermöglicht das Speichern und Verwalten von 240 Job, die vom Bediener personalisiert werden können.

Programme (JOB)

Kapitel "Haupt-Menü" einsehen

Programm-Speicher

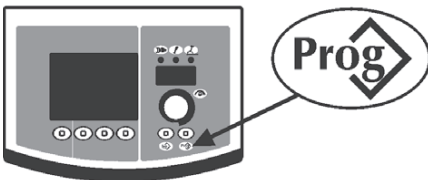

- ▶ Gehen Sie in das Menü "Programm speichern" hinein, indem Sie die Taste für mindestens eine Sekunde aufrufen.

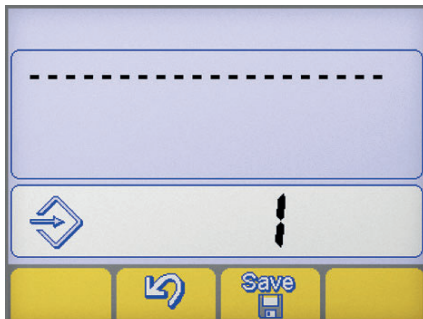

- ▶ Wählen Sie das gewünschte Programm (oder den freien Speicherplatz), indem Sie den Encoder drehen.

--- Speicher leer

Programm gespeichert

- ▶ Brechen Sie den Vorgang ab, indem Sie die Taste drücken .
- ▶ Speichern Sie alle aktuellen Einstellungen im gewählten Programm, indem Sie die Taste drücken. .

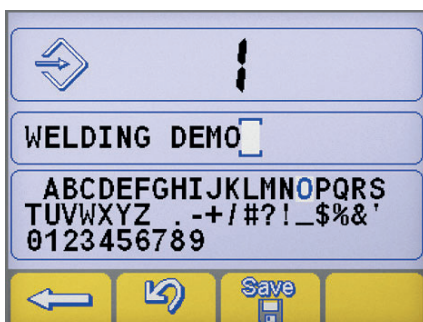

Geben Sie einen Namen für das Programm ein.

- ▶ Wählen Sie den gewünschten Buchstaben, indem Sie den Encoder drehen.
- ▶ Speichern Sie den gewählten Buchstaben, indem Sie den Taster Encoder drücken.
- ▶ Löschen Sie das letzte Zeichen, indem Sie die Taste drücken. .
- ▶ Brechen Sie den Vorgang ab, indem Sie die Taste drücken .
- ▶ Bestätigen Sie den Vorgang, indem Sie die Taste drücken .



Das Speichern eines neuen Programms auf einem bereits belegten Speicherplatz erfordert das Löschen des Speicherplatzes durch einen vorgeschriebenen Ablauf.

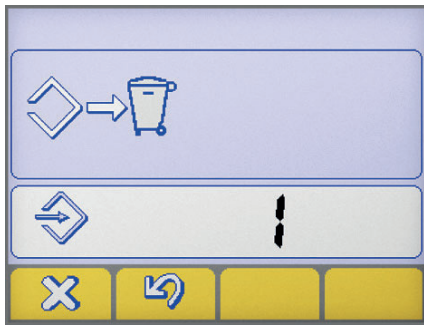

- ▶ Brechen Sie den Vorgang ab, indem Sie die Taste drücken
- ▶ Löschen Sie das ausgewählte Programm, indem Sie die Taste drücken.
- ▶ Setzen Sie den Speichervorgang fort.

Programmabruf

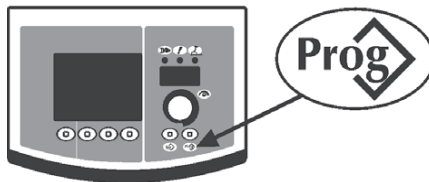

- ▶ Durch Drücken der Taste rufen Sie das 1 verfügbare Programm auf
 - ▶ Wählen Sie das gewünschte Programm, indem Sie den Encoder drehen.
 - ▶ Wählen Sie das gewünschte Programm aus, indem Sie die Taste drücken.
- Nur die belegten Programmspeicherplätze werden angezeigt, während die leeren automatisch übersprungen werden.

Programm löschen



- ▶ Wählen Sie das gewünschte Programm, indem Sie den Encoder drehen.
- ▶ Löschen Sie das ausgewählte Programm, indem Sie die Taste drücken.
- ▶ Brechen Sie den Vorgang ab, indem Sie die Taste drücken



- ▶ Brechen Sie den Vorgang ab, indem Sie die Taste drücken
- ▶ Löschen Sie das ausgewählte Programm, indem Sie die Taste drücken.

5. SETUP

5.1 Setup und Parametereinstellung

Ermöglicht die Einstellung und Regelung einer Reihe Zusatzparameter, um die Schweißanlage besser und präziser betreiben zu können.

Die im Setup vorhandenen Parameter sind nach dem gewählten Schweißprozess geordnet und haben eine Nummerncodierung.

Zugriff auf Setup





- ▶ Erfolgt durch 5 Sekunden langes Drücken der Encoder-Taste.
- ▶ Der Zugriff wird durch den Eintrag 0 am Display bestätigt.

Auswahl und Einstellung des gewünschten Parameters

- ▶ Erfolgt durch Drehen des Encoders bis zur Anzeige des Nummerncodes des gewünschten Parameters.
- ▶ Durch Drücken der Taste Encoder wird nun der für den gewählten Parameter eingestellte Wert sichtbar und kann reguliert werden.

Verlassen des Setup

- ▶ Um den Abschnitt „Einstellungen“ zu verlassen, erneut auf die Taste Encoder drücken.
- ▶ Um das Setup zu verlassen, auf Parameter "0" (Speichern und Beenden) gehen und erneut auf die Taste Encoder drücken.
- ▶ Brechen Sie den Vorgang ab, indem Sie die Taste drücken .
- ▶ Zum Speichern der Änderungen und Verlassen des Setups folgende Taste drücken: .

5.1.1 Liste der Setup-Parameter (E-Hand-Schweißen)

0 Speichern und Beenden
 Für das Speichern der Änderungen und Verlassen des Setup.

1 Reset
 Für die Rücksetzung aller Parameter auf die Standardwerte.

3 Hotstart
 Für die Einstellung des Hot-Start-Wertes beim E-Hand-Schweißen.
 Ermöglicht einen verstellbaren Hot-Start-Wert der Zündphasen des Bogens und erleichtert die Startvorgänge.

Basisch elektroden

Minimum	Maximal	Standard
0/aus	500%	80%

Zellulose elektroden

Minimum	Maximal	Standard
0/aus	500%	150%

CrNi-elektroden

Minimum	Maximal	Standard
0/aus	500%	100%

Aluminiumelektrode

Minimum	Maximal	Standard
0/aus	500%	120%

Gusseisenelektrode

Minimum	Maximal	Standard
0/aus	500%	100%

Rutilelektrode

Minimum	Maximal	Standard
0/aus	500%	80%

7 Schweißstrom
 Ermöglicht die Einstellung des Schweißstroms.

Minimum	Maximal	Standard
3 A	I _{max}	100 A

8 Arc force
 Für die Einstellung des Arc-Force-Wertes beim E-Hand-Schweißen.
 Ermöglicht die Dynamikkorrektur des Bogens (plus oder minus) während des Schweißens. Dadurch wird die Arbeit des Schweißers erleichtert.

Ein Anheben des Wertes der Bogenstärke verringert das Risiko des Festklebens der Elektrode.

Basisch elektroden

Minimum	Maximal	Standard
0/aus	500%	30%

Zellulose elektroden

Minimum	Maximal	Standard
0/aus	500%	350%

CrNi-elektroden

Minimum	Maximal	Standard
0/aus	500%	30%

Aluminiumelektrode

Minimum	Maximal	Standard
0/aus	500%	100%

Gusseisenelektrode

Minimum	Maximal	Standard
0/aus	500%	70%

Rutilelektrode

Minimum	Maximal	Standard
0/aus	500%	80%

DE

204 Dynamic power control (DPC)



Ermöglicht, die gewünschte U/I - Charakteristik auszuwählen.

I=C Konstanter Strom

Die Vergrößerung oder Reduzierung der Bogenhöhe hat keine Auswirkung auf den erforderlichen Schweißstrom.
Empfohlen für Elektrode: Basisch, Rutil, Sauer hohe, Stahl, Guss

1÷20 Reduzierungscharakteristik mit Rampenregelung

Das Ansteigen der Bogenhöhe verursacht eine Reduzierung des Schweißstroms (und umgekehrt) entsprechend dem festen Wert von 1/20 Ampere pro Volt.

Empfohlen für Elektrode: Cellulose, Aluminium

P=C Konstante Leistung

Das Ansteigen der Bogenhöhe verursacht eine Reduzierung des Schweißstroms (und umgekehrt) entsprechend der Regel: $V \cdot I = K$

Empfohlen für Elektrode: Cellulose, Aluminium

312 Bogenabtrennspannung



Zur Einstellung des Spannungswertes, bei dem das Abtrennen des Schweißbogens erzwungen werden soll.

Verbessert den Umgang mit verschiedenen auftretenden Betriebsbedingungen.

Beim Punktschweißen zum Beispiel reduziert eine niedrige Bogenabtrennspannung die erneute Zündung des Bogens beim Entfernen der Elektrode vom Werkstück, vermindert Spritzer, Verbrennungen und Oxidation des Werkstücks.



Niemals eine Bogenabtrennspannung einstellen, die größer als die Leerlaufspannung des Generators ist.

Basisch elektroden

Minimum	Maximal	Standard
0/aus	Vmax	57.0 V

Zellulose elektroden

Minimum	Maximal	Standard
0/aus	Vmax	70.0 V

399 Schweißgeschwindigkeit



Ermöglicht die Einstellung der Ausführungsgeschwindigkeit der Schweißarbeit.

Default cm/min: Bezugsgeschwindigkeit für manuelles Schweißen.

Syn: Sinergic Wert.

Minimum	Maximal	Standard
2 cm/min	200 cm/min	15 cm/min

500 Maschineneinstellung



Ermöglicht die Auswahl der erforderlichen Grafikschnittstelle.

Ermöglicht den Zugang zu höheren Setup Levels.

Siehe Abschnitt "Interface-Personalisierung (Set up 500)"

Wert	Ausgewählte Ebene
USER	Bediener
SERV	Bedienung
vaBW	vaBW

Wert	Benutzeroberfläche
XE	Modus Easy
XA	Modus Advanced
XP	Modus Professional

551 Lock/unlock



Ermöglicht das Sperren der Bedienfelder und die Einführung eines Schutzcodes.

Siehe Abschnitt "Lock/unlock (Set up 551)".

552 Lautstärke der akustischen Warnvorrichtung



Zur Einstellung der Lautstärke der akustischen Warnvorrichtung.

Minimum	Maximal	Standard
0/aus	10	10

601 Schrittweite



Ermöglicht die Regulierung eines Parameters mit einer Schrittweite, die vom Bediener persönlich eingestellt werden kann.

Minimum	Maximal	Standard
1	Imax	1

602 Externer Parameter 2
 Ermöglicht das Verwalten externer Parameter 2 (Minimalwert, Maximalwert, Standardwert, gewählter Parameter).



705 Kalibrierung des Schweißkreiswiderstands
 Ermöglicht die Einstellung der Anlage.
 Siehe Abschnitt "Kalibrierung des Schweißkreiswiderstands (set up 705)".



751 Stromanzeige
 Ermöglicht die Anzeige des Ist-Schweißstroms.



752 Spannungsanzeige
 Ermöglicht die Anzeige der Ist-Schweißspannung.

768 Messung Wärmeeintrag HI
 Ermöglicht das Ablesen des Wertes der Messung des Wärmeeintrags beim Schweißen.



5.1.2 Liste der Setup-Parameter (WIG-Schweißen)

0 Speichern und Beenden
 Für das Speichern der Änderungen und Verlassen des Setup.



1 Reset
 Für die Rücksetzung aller Parameter auf die Standardwerte.

2 Gasvorströmen
 Für die Einstellung und Regelung des Gasflusses vor der Bogenzündung.
 Für das Laden des Gases in den Brenner und die Vorbereitung der Umgebung auf das Schweißen.



Minimum	Maximal	Standard
0/aus	99.9 s	0.1 s

3 Startstrom
 Ermöglicht die Einstellung des Start-Schweißstroms.
 Ermöglicht das Erhalten eines heißeren oder kühleren Schmelzbades unmittelbar nach der Bogenzündung.



Minimum	Maximal	Standard	Minimum	Maximal	Standard
1%	200%	50%	3 A	I _{max}	-

5 Startstrom-Zeit
 Ermöglicht das Einstellen der Zeit, zu welcher der Initialstrom erreicht werden soll.

Minimum	Maximal	Standard
0/aus	99.9 s	0/aus

6 Anstiegsrampe
 Für die Eingabe eines stufenweisen Übergangs vom Startstrom auf Schweißstrom.

Minimum	Maximal	Standard
0/aus	99.9 s	0/aus

7 Schweißstrom
 Ermöglicht die Einstellung des Schweißstroms.

Minimum	Maximal	Standard
3 A	I _{max}	100 A

8 Bilevel-Strom



Für die Einstellung des Sekundärstroms in der Schweißmethode Bilevel.
 Beim ersten Drücken des Brenner-Druckknopfs erfolgt die Gasvorströmzeit, die Bogenzündung und das Schweißen mit Anfangsstrom.
 Beim ersten Loslassen erfolgt die Anstiegslope zum Schweißstrom "I1".
 Wenn der Schweißer den Knopf drückt und ihn schnell losläßt, geht man zum zweiten Schweißstrom "I2" über.
 Drücken und schnelles Loslassen des Knopfes geht man wieder auf "I1" usw. über.
 Bei längerem Drücken beginnt man die Abstiegsslope des Stroms bis zum Endstrom.
 Beim Loslassen des Knopfs schaltet sich der Bogen aus und das Gas fließt für Gasnachströmzeit weiter.

Minimum	Maximal	Standard	Minimum	Maximal	Standard
3 A	I _{max}	-	1%	500%	aus

10 Basisstrom



Für die Einstellung des Basisstroms im „pulsed“ und „fast pulse“ Modus.

Minimum	Maximal	Standard	Minimum	Maximal	Standard
3 A	I _{sald}	-	1%	100%	50%

12 Impulsfrequenz



Ermöglicht die Einstellung der Impuls-Frequenz.
 Ermöglicht das Erzielen besserer Ergebnisse beim Schweißen von dünnen Materialien und bessere optische Qualität der Raupe.

Minimum	Maximal	Standard
0.1 Hz	25 Hz	5 Hz

13 Impuls-Einschaltdauer



Ermöglicht die Einstellung der Einschaltdauer beim Impuls-Schweißen.
 Ermöglicht das Aufrechterhalten des Spitzenstroms für eine längere oder kürzere Zeit.

Minimum	Maximal	Standard
1 %	99 %	50 %

14 Schnelle Impuls-Frequenz



Ermöglicht die Einstellung der Impuls-Frequenz.
 Ermöglicht eine Fokussierung und das Erzielen besserer Stabilität des elektrischen Lichtbogens.

Minimum	Maximal	Standard
0.02 KHz	2.5 KHz	0.25 KHz

15 Impulssteilheit



Ermöglicht die Einstellung einer Rampen-Zeit während des Impulsbetriebs.
 Ermöglicht das Erzielen eines allmählichen Übergangs zwischen Spitzen- und Grundstrom mit einem mehr oder weniger soften Schweißbogen.

Minimum	Maximal	Standard
0/aus	100 %	0/aus

16 Abstiegsrampe



Für die Eingabe eines stufenweisen Übergangs vom Schweißstrom auf Endkraterstrom.

Minimum	Maximal	Standard
0/aus	99.9 s	0/aus

17 Endkraterstrom



Für die Einstellung des Endkraterstroms.

Minimum	Maximal	Standard	Minimum	Maximal	Standard
3 A	I _{max}	10 A	1%	200%	50%

19 Endkraterstrom-Zeit



Ermöglicht das Einstellen der Zeit, für die der Endstrom aufrechterhalten werden soll.

Minimum	Maximal	Standard
0/aus	99.9 s	0/aus

DE

20 Gasnachströmen



Für die Einstellung des Gasflusses bei Schweißende.

Minimum	Maximal	Standard
0/aus	99.9 s	syn

203 Wig start (HF)

Ermöglicht die Auswahl der benötigten Bogenzündungsart.

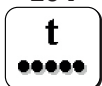
Wert	Standard	Rückruffunktion
ein	X	HF START
aus	-	LIFT START

204 Punktschweißen

Für die Aktivierung des Punktschweißens und die Festlegung der Schweißzeit.

Ermöglicht das Takten des Schweißvorgangs.

Minimum	Maximal	Standard
0/aus	99.9 s	0/aus

205 Wiederzündung

Ermöglicht die Aktivierung der Funktion „Wiederzünden“.

Ermöglicht das sofortige Erlöschen des Bogens während des Downslope oder das Wiederzünden des Schweißvorgangs.

Wert	Standard	Rückruffunktion
0/aus	-	aus
1/on	X	ein
2/of1	-	aus

206 Easy joining

Ermöglicht die Zündung des Bogens mit Impulsstrom und Takten der Funktion bevor die voreingestellten Schweißbedingungen automatisch wiederhergestellt werden.

Ermöglicht eine höhere Geschwindigkeit und Genauigkeit während der Heftschweißarbeiten an den Werkstücken.

Minimum	Maximal	Standard
0.1 s	25.0 s	0/aus

208 Microtime spot welding

Für die Aktivierung des "Microtime spot welding".

Ermöglicht das Takten des Schweißvorgangs.

Minimum	Maximal	Standard
0.01 s	1.00 s	0/aus

399 Schweißgeschwindigkeit

Ermöglicht die Einstellung der Ausführungsgeschwindigkeit der Schweißarbeit.

Default cm/min: Bezugsgeschwindigkeit für manuelles Schweißen.

Syn: Sinergic Wert.

Minimum	Maximal	Standard
2 cm/min	200 cm/min	10 cm/min

500 Maschineneinstellung

Ermöglicht die Auswahl der erforderlichen Grafikschnittstelle.

Ermöglicht den Zugang zu höheren Setup Levels.

Siehe Abschnitt "Interface-Personalisierung (Set up 500)"

Wert	Ausgewählte Ebene	Wert	Benutzeroberfläche
USER	Bediener	XE	Modus Easy
SERV	Bedienung	XA	Modus Advanced
vaBW	vaBW	XP	Modus Professional

551 Lock/unlock

Ermöglicht das Sperren der Bedienfelder und die Einführung eines Schutzcodes.

Siehe Abschnitt "Lock/unlock (Set up 551)".

552 Lautstärke der akustischen Warnvorrichtung



Zur Einstellung der Lautstärke der akustischen Warnvorrichtung.

Minimum	Maximal	Standard
0/aus	10	10

601 Schrittweite



Ermöglicht die Regulierung eines Parameters mit einer Schrittweite, die vom Bediener persönlich eingestellt werden kann.

Minimum	Maximal	Standard
1	lmax	1

602 Externer Parameter CH1, CH2, CH3, CH4



Ermöglicht das Verwalten externer Parameter 1, 2, 3, 4 (Minimalwert, Maximalwert, Standardwert, gewählter Parameter).

Siehe Abschnitt "Verwaltung Externer Steuerungen (Set up 602)".

606 U/D Brenner



Ermöglicht das Verwalten externer Parameter (U/D).

Wert	Standard	Rückruffunktion
0/aus	-	aus
1/11	X	Strom
	-	Programmabruf

612 Einstellung Schweißbrenner DgTig



Ermöglicht die Steuerung der Kanäle des digitalen Schweißbrenners.

Wert	Standard	Rückruffunktion
0/aus	-	aus
1/11	-	Strom
2/	-	Programmabruf
3/CH3	-	CH3
4/CH4	-	CH4
5/STD	X	STD

705 Kalibrierung des Schweißkreiswiderstands



Ermöglicht die Einstellung der Anlage.

Siehe Abschnitt "Kalibrierung des Schweißkreiswiderstands (set up 705)".

751 Stromanzeige



Ermöglicht die Anzeige des Ist-Schweißstroms.

752 Spannungsanzeige



Ermöglicht die Anzeige der Ist-Schweißspannung.

758 Geschwindigkeit der Roboterbewegung



Ermöglicht die Anzeige der Geschwindigkeit des Roboterarms oder der automatischen Anlage.

764 Anzeige des Kühlmitteldurchflusses



Ermöglicht die Anzeige des Kühlmitteldurchflusses.

DE

765 **Anzeige der Kühlmitteltemperatur**
 Ermöglicht die Anzeige der Kühlmitteltemperatur.

768 **Messung Wärmeeintrag HI**
 Ermöglicht das Ablesen des Wertes der Messung des Wärmeeintrags beim Schweißen.

801 **Schutzgrenzen**
 Ermöglicht die Einstellung der Warn- und Schutzgrenzen.
 Ermöglicht die Steuerung des Schweißverfahrens, indem Warn- und Schutzgrenzen für die messbaren Hauptparameter eingestellt werden.
 Ermöglicht die genaue Steuerung der verschiedenen Schweißphasen.

5.2 Spezielle Verfahren zur Verwendung der Parameter

5.2.1 Personalisierung der 7-Segment-Anzeige

Ermöglicht die konstante Anzeige eines Parameterwerts auf dem Display mit 7 Segmenten.

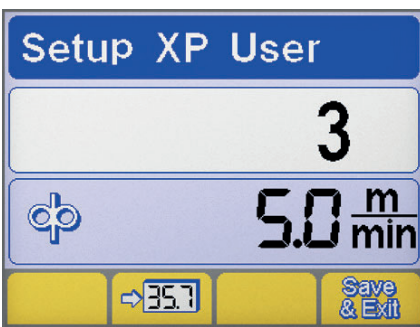

- ▶ Gehen Sie ins Set-up hinein, indem Sie den Taster Encoder für mindestens 5 Sekunden drücken.
- ▶ Wählen Sie den gewünschten Parameter, indem Sie den Encoder drehen.
- ▶ Speichern Sie den gewählten Parameter in der 7-Segment-Anzeige, indem Sie die Taste drücken **35.7**.
- ▶ Speichern und verlassen Sie das aktuelle Menü, indem Sie die Taste drücken **Save & Exit**.













5.2.2 Interface-Personalisierung (Set up 500)

Ermöglicht das Anpassen der Parameter im Haupt-Menü.

500 **Maschineneinstellung**
 Ermöglicht die Auswahl der erforderlichen Grafikschnittstelle.

Wert	Benutzeroberfläche
XE	Modus Easy
XA	Modus Advanced
XP	Modus Professional

MODUS XE

E-HAND	
Schweißparameter	
WIG	
Schweißparameter	    
Funktionen	      

MODUS XA

E-HAND	
Schweißparameter	
Funktionen	
WIG	
Schweißparameter	
Funktionen	

MODUS XP

E-HAND	
Schweißparameter	
Funktionen	
WIG	
Schweißparameter	
Funktionen	

5.2.3 Lock/unlock (Set up 551)

Ermöglicht das Sperren der Bedienfelder und die Einführung eines Schutzcodes.

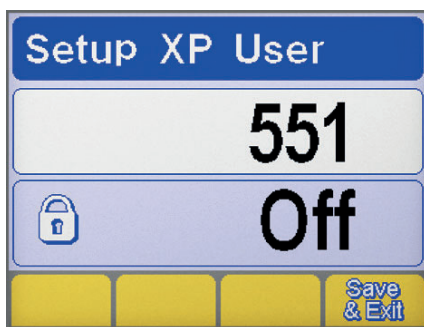

Parameterauswahl

- ▶ Gehen Sie ins Set-up hinein, indem Sie den Taster Encoder für mindestens 5 Sekunden drücken.
- ▶ Wählen Sie den gewünschten Parameter aus (551).
- ▶ Aktivieren Sie die Einstellung des gewählten Parameters, indem Sie den Taster Encoder drücken.

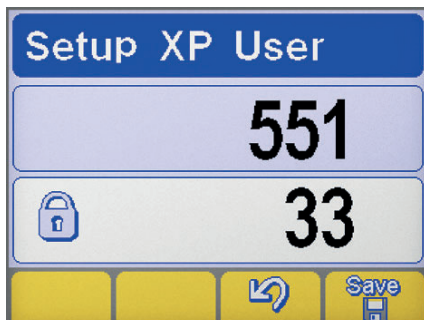

Passworteinstellung

- ▶ Stellen Sie einen Nummerncode (Passwort) ein, indem Sie den Encoder drehen.
- ▶ Den Vorgang durch Drücken der Encoder-Taste bestätigen.
- ▶ Brechen Sie den Vorgang ab, indem Sie die Taste drücken .
- ▶ Zum Speichern der Änderungen folgende Taste drücken: .

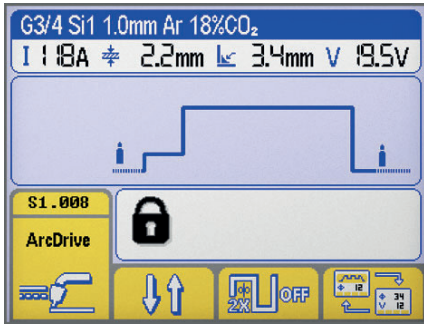

Bedienfeld-Funktionen



Jedes Ausführen eines Vorganges an einem gesperrten Bedienfeld ruft diese Anzeige hervor.

- ▶ Entsperren Sie das Bedienfeld zeitweise (für 5 Minuten), indem Sie den Encoder drehen und das richtige Passwort eingeben.
- ▶ Den Vorgang durch Drücken der Encoder-Taste bestätigen.
- ▶ Entsperren Sie das Bedienfeld dauerhaft, indem Sie ins Set-up hineingehen (Befolgen Sie die oben gemachten Anweisungen!) und setzen Sie den Parameter 551 zurück auf "OFF".
- ▶ Den Vorgang durch Drücken der Encoder-Taste bestätigen.
- ▶ Zum Speichern der Änderungen folgende Taste drücken:

5.2.4 Verwaltung Externer Steuerungen (Set up 602)

Ermöglicht das Verwalten externer Parameter 2 (Minimalwert, Maximalwert, Standardwert, gewählter Parameter).

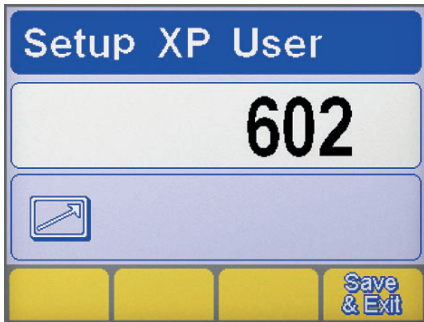

Parameterauswahl

- ▶ Gehen Sie ins Set-up hinein, indem Sie den Taster Encoder für mindestens 5 Sekunden drücken.
- ▶ Wählen Sie den gewünschten Parameter aus (602).
- ▶ Gehen Sie ins Menü "Verwaltung Externer Steuerungen" hinein, indem Sie den Taster Encoder drücken.

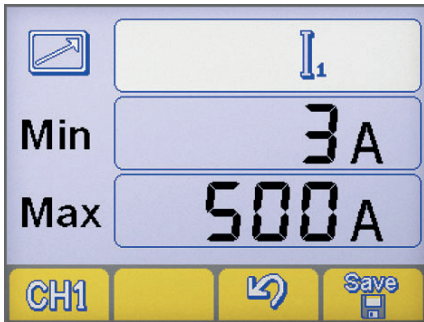

Verwaltung Externer Steuerungen

- ▶ Wählen Sie den gewünschten Ausgang der RC Fernsteuerung (CH1, CH2, CH3, CH4), indem Sie die Taste drücken
- ▶ Wählen Sie den gewünschten Parameter (Min-Max-parameter), indem Sie den Taster Encoder drücken.
- ▶ Stellen Sie den gewünschten Parameter (Min-Max-parameter) ein, indem Sie den Encoder drehen.
- ▶ Zum Speichern der Änderungen folgende Taste drücken:
- ▶ Brechen Sie den Vorgang ab, indem Sie die Taste drücken

5.2.5 Kalibrierung des Schweißkreiswiderstands (set up 705)

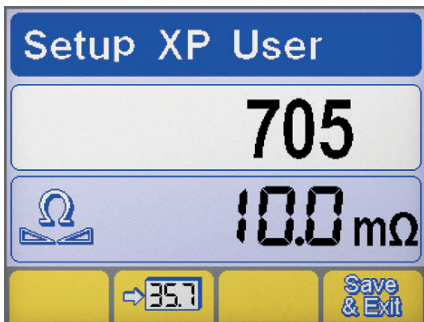

Parameterauswahl

- ▶ Gehen Sie ins Set-up hinein, indem Sie den Taster Encoder für mindestens 5 Sekunden drücken.
- ▶ Wählen Sie den gewünschten Parameter aus (705).
- ▶ Aktivieren Sie die Einstellung des gewählten Parameters, indem Sie den Taster Encoder drücken.

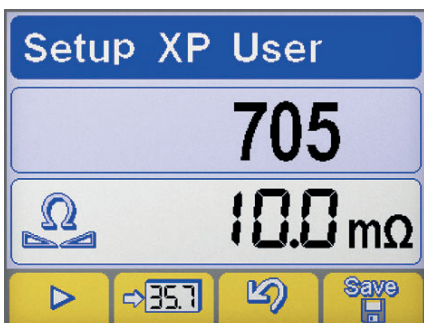

Kalibrierung

- ▶ Elektrischen Kontakt zwischen Wolframelektroden und Schweißwerkstück herstellen. (TIG)
- ▶ Bringen Sie den Elektrodenhalterbrenner und das zu schweißende Werkstück in Kontakt. (MMA)
- ▶ Taste (oder Brenntaste die Taste) zum Starten des Vorgangs drücken.
- ▶ Die Berührung muss mindestens eine Sekunde lang bestehen.
- ▶ Der am Display gezeigte Wert wird nach der Einstellung aktualisiert.
- ▶ Bestätigen Sie den Vorgang, indem Sie die Taste drücken
- ▶ Brechen Sie den Vorgang ab, indem Sie die Taste drücken
- ▶ Zum Speichern der Änderungen und Verlassen des Setups folgende Taste drücken:

DE

5.2.6 Schutzgrenzen (Set up 801)

Ermöglicht die Einstellung der Warn- und Schutzgrenzen.

Ermöglicht die Steuerung des Schweißverfahrens, indem Warn- und Schutzgrenzen für die messbaren Hauptparameter eingestellt werden.

Ermöglicht die genaue Steuerung der verschiedenen Schweißphasen.

Siehe Abschnitt "Schutzgrenzen (Set up 801)".



- | | |
|------------------------------------|-------------------------------------|
| Schweißstrom | Schweißspannung |
| Gasdurchfluss-Anzeige | Geschwindigkeit der Roboterbewegung |
| Stromanzeige (Motor 1) | Stromanzeige (Motor 2) |
| Anzeige des Kühlmitteldurchflusses | Anzeige der Drahtgeschwindigkeit |
| Anzeige der Kühlmitteltemperatur | |

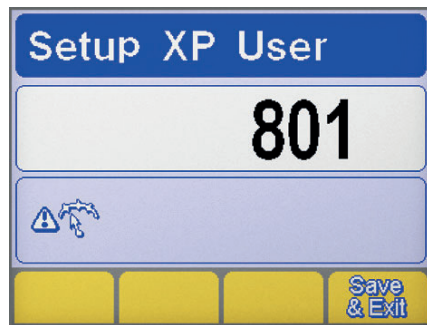

Parameterwahl

- ▶ Gehen Sie ins Set-up hinein, indem Sie den Taster Encoder für mindestens 5 Sekunden drücken.
- ▶ Wählen Sie den gewünschten Parameter aus (801).
- ▶ Gehen Sie ins Menü "Schutzgrenzen" hinein, indem Sie den Taster Encoder drücken.

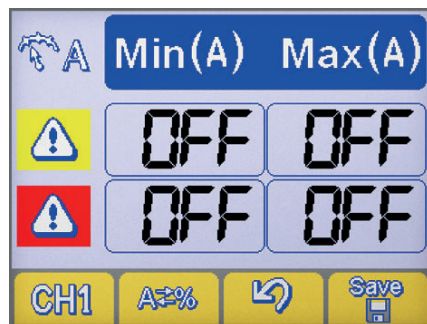

Parameterwahl

- ▶ Wählen Sie den gewünschten Parameter, indem Sie die Taste drücken **CH1**.
- ▶ Wählen Sie die Einstellungsmethode der Schutzgrenzen, indem Sie die Taste drücken. **A%**.



Absoluter Wert

Prozentwert

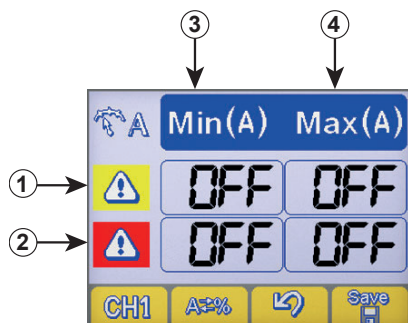

Einstellung der Schutzgrenzen

- ① Zeile Warngrenzen
- ② Zeile Alarmgrenzen
- ③ Spalte Minimalgrenze
- ④ Spalte Maximalgrenze

- ▶ Wählen Sie den gewünschten Kasten, indem Sie den Taster Encoder drücken (der ausgewählte Kasten wird invers dargestellt).
- ▶ Stellen Sie den Wert der gewählten Grenze ein, indem Sie den Encoder drehen.
- ▶ Zum Speichern der Änderungen folgende Taste drücken: .



Das Überschreiten einer der Schutzgrenzen lässt ein sichtbares Signal auf dem Bedienfeld erscheinen.



Das Überschreiten einer der Alarmgrenzen lässt ein sichtbares Signal auf dem Bedienfeld erscheinen und löst die sofortige Blockade des Schweißvorgangs aus.



Es ist möglich Anfangs- und Endfilter für das Schweißen einzustellen, um Fehlermeldungen während des Zündens und Erlöschens des Lichtbogens vorzubeugen (siehe Abschnitt "Set-up" - Parameter 802-803-804).

6. WARTUNG



Die regelmäßige Wartung der Anlage muss nach den Angaben des Herstellers erfolgen. Wenn das Gerät in Betrieb ist, müssen alle Zugangs-, Wartungstüren und Abdeckungen geschlossen und verriegelt sein. Die Anlage darf keiner Änderung unterzogen werden. Vermeiden Sie Ansammlungen von Metallstaub in der Nähe und über den Lüftungsschlitzen.



Jeder Wartungseingriff darf nur von Fachpersonal ausgeführt werden. Das Reparieren oder Austauschen von Anlageteilen durch unautorisiertes Personal hebt die Produktgarantie auf. Das Reparieren oder Austauschen von Anlageteilen darf ausschließlich von Fachpersonal ausgeführt werden.



Trennen Sie die Anlage von der Stromzufuhr vor jedem Wartungseingriff!

6.1 Führen Sie folgende regelmäßige Überprüfungen am Generator durch

6.1.1 Anlage



Das Innere der Anlage mittels Druckluft mit niederem Druck und weichen Pinseln reinigen. Elektrische Verbindungen und Anschlusskabel prüfen.

6.1.2 Für die Instandhaltung oder das Austauschen von Schweißbrennersbestandteilen, der Schweißzange und/oder der Erdungskabel:



Die Temperatur der Teile kontrollieren und sicherstellen, dass sie nicht mehr heiß sind.



Immer Schutzhandschuhe anziehen, die den Sicherheitsstandards entsprechen.



Geeignete Schlüssel und Werkzeuge verwenden.

6.2 Verantwortung



Durch Unterlassung der oben genannten Wartung wird jegliche Garantie aufgehoben und der Hersteller wird von jeglicher Haftung befreit. Der Hersteller übernimmt keinerlei Haftung, falls sich der Benutzer nicht an diese Vorschriften hält. Wenden Sie sich bei jedem Zweifel und/oder bei jedem Problem an die nächstgelegene Technische Kundendienststelle.

7. ALARMCODES



ALARM

Die Auslösung eines Alarms bzw. das Überschreiten einer kritischen Warnschwelle hat eine entsprechende Anzeige am Bedienfeld sowie den sofortigen Abbruch der Schweißvorgänge zur Folge.



ACHTUNG

Das Überschreiten einer Schutzgrenze verursacht ein visuelles Signal auf dem Bedienfeld, ermöglicht jedoch die Fortsetzung der Schweißvorgänge.

Nachstehend sind alle Alarmer und Warnschwellen der Anlage aufgelistet.

 E01	Übertemperatur		 E02	Übertemperatur	
 E03	Übertemperatur		 E05	Überstrom	
 E06	Überstrom des Leistungsmoduls (Boost)		 E07	Fehler in der Stromversorgung des Drahtvorschubmotors	
 E08	Motor blockiert		 E10	Überstrom des Leistungsmoduls (Inverter)	
 E11	Anlagen-Konfigurationsfehler		 E13	Kommunikationsfehler (FP)	
 E14.xx	Ungültiges Programm Der Untercode des Fehlers bezeichnet die Nummer des gelöschten Auftrags		 E15	Ungültiges Programm	
 E16	Kommunikationsfehler (RI) (Automatisierungs- und Robotertechnik)		 E18.xx	Ungültiges Programm Der Untercode des Fehlers bezeichnet die Nummer des gelöschten Auftrags	
 E19	Anlagen-Konfigurationsfehler		 E20	Speicher defekt	
 E21	Datenverlust		 E22	Kommunikationsfehler (DSP)	
 E27	Speicher defekt (RTC)		 E29	Maße unvereinbar	
 E30	Kommunikationsfehler (H.F.)		 E32	Datenverlust	
 E33	Anlagen-Konfigurationsfehler (LCD 3.5")		 E38	Unterspannung	
 E39	Stromversorgung der Anlage Fehler		 E40	Stromversorgung der Anlage Fehler	
 E41	Überspannung		 E42	Unterspannung	

 E43	Kühlmittelmangel		 E49	Notschalter (Automatisierungs- und Robotertechnik)	
 E51	Einstellungen nicht unterstützt (Automatisierungs- und Robotertechnik)		 E52	Anti-Kollision (Automatisierungs- und Robotertechnik)	
 E53	Externer Gasdurchflussmesser Fehler (Automatisierungs- und Robotertechnik)		 E54	Stromgrenze überschritten (Untere Grenze)	
 E55	Stromgrenze überschritten (Obere Grenze)		 E56	Spannungsgrenze überschritten (Untere Grenze)	
 E57	Spannungsgrenze überschritten (Obere Grenze)		 E58	Gasdurchflussgrenze überschritten (Untere Grenze)	
 E59	Gasdurchflussgrenze überschritten (Obere Grenze)		 E62	Stromgrenze überschritten (Untere Grenze)	
 E63	Stromgrenze überschritten (Obere Grenze)		 E64	Spannungsgrenze überschritten (Untere Grenze)	
 E65	Spannungsgrenze überschritten (Obere Grenze)		 E66	Gasdurchflussgrenze überschritten (Untere Grenze)	
 E67	Gasdurchflussgrenze überschritten (Obere Grenze)		 E71	Übertemperatur des Kühlmittels	
 E72	Push-Pull-Motorüberstrom		 E73	Drahtgeschwindigkeitsbegrenzung überschritten (speed meter)	
 E75	Stromgrenze Motor 2 überschritten		 E76	Kühlmitteldurchflussgrenze überschritten	
 E77	Kühlmitteltemperaturgrenze überschritten		 E78	Wartung aktiviert (Automatisierungs- und Robotertechnik)	
 E81	Überstrom (Pump-WU)		 E82	Kommunikationsfehler (WU)	
 E83	Pump-blockiert		 E99	Allgemeiner Alarm	

8. FEHLERSUCHE

Anlage lässt sich nicht einschalten (grüne LED aus)

Ursache

- » Keine Netzspannung an Versorgungssteckdose.
- » Stecker oder Versorgungskabel defekt.
- » Netzsicherung durchgebrannt.
- » Hauptschalter defekt.
- » Elektronik defekt.

Lösung

- » Elektrische Anlage überprüfen und ggf. reparieren.
- » Nur Fachpersonal dazu einsetzen.
- » Schadhafte Teil ersetzen.
- » Anlage von der nächstgelegenen Kundendienststelle reparieren lassen.
- » Schadhafte Teil ersetzen.
- » Schadhafte Teil ersetzen.
- » Anlage von der nächstgelegenen Kundendienststelle reparieren lassen.
- » Anlage von der nächstgelegenen Kundendienststelle reparieren lassen.

Keine Ausgangsleistung (Anlage schweißt nicht)

Ursache

- » Brenntaste defekt.
- » Anlage überhitzt (Übertemperaturalarm - gelbe LED an).
- » Masseverbindung unkorrekt.
- » Netzspannung außerhalb des Bereiches der zulässigen Betriebsspannung (gelbe LED an).
- » Schütz defekt.
- » Elektronik defekt.

Lösung

- » Schadhafte Teil ersetzen.
- » Anlage von der nächstgelegenen Kundendienststelle reparieren lassen.
- » Warten, bis die Anlage abgekühlt ist, die Anlage aber nicht ausschalten.
- » Korrekte Masseverbindung ausführen.
- » Siehe Kapitel "Inbetriebnahme".
- » Netzspannung wieder in den Bereich der zulässigen Betriebsspannung des Generators bringen.
- » Korrekten Anschluss der Anlage ausführen.
- » Siehe Kapitel "Anschluss".
- » Schadhafte Teil ersetzen.
- » Anlage von der nächstgelegenen Kundendienststelle reparieren lassen.
- » Anlage von der nächstgelegenen Kundendienststelle reparieren lassen.

Falsche Ausgangsleistung

Ursache

- » Falsche Auswahl des Schweißverfahrens oder Wahlschalter defekt.
- » Falsche Einstellungen der Parameter und der Funktionen der Anlage.
- » Potentiometer/Encoder zur Regulierung des Schweißstroms defekt.
- » Netzspannung außerhalb des Bereiches der zulässigen Betriebsspannung.
- » Ausfall einer Phase.
- » Elektronik defekt.

Lösung

- » Korrekte Auswahl des Schweißverfahrens treffen.
- » Ein Reset der Anlage ausführen und die Schweißparameter neu einstellen.
- » Schadhafte Teil ersetzen.
- » Anlage von der nächstgelegenen Kundendienststelle reparieren lassen.
- » Korrekten Anschluss der Anlage ausführen.
- » Siehe Kapitel "Anschluss".
- » Korrekten Anschluss der Anlage ausführen.
- » Siehe Kapitel "Anschluss".
- » Anlage von der nächstgelegenen Kundendienststelle reparieren lassen.

Unstabiler Lichtbogen

Ursache

- » Schutzgas ungenügend.

Lösung

- » Druckluftdurchfluss korrekt regulieren.
- » Prüfen, dass Diffusor und Gasdüse am Brenner in gutem Zustand sind.

» Feuchtigkeit im Schweißgas.	» Immer Produkte und Materialien hochwertiger Qualität benutzen.
» Schweißparameter unkorrekt.	» Für den einwandfreien Zustand der Gaszuleitung sorgen.
	» Schweißanlage genau kontrollieren.
	» Anlage von der nächstgelegenen Kundendienststelle reparieren lassen.

Zu viele Spritzer

Ursache	Lösung
» Bogenlänge unkorrekt.	» Abstand zwischen Elektrode und Werkstück reduzieren.
	» Schweißspannung verringern.
» Schweißparameter unkorrekt.	» Schweißstrom verringern.
» Schutzgas ungenügend.	» Druckluftdurchfluss korrekt regulieren.
	» Prüfen, dass Diffusor und Gasdüse am Brenner in gutem Zustand sind.
» Bogendynamik unkorrekt.	» Induktivitätswert des Schweißkreises erhöhen.
» Durchführung des Schweißens unkorrekt.	» Brennerneigung reduzieren.

Ungenügende Durchstrahlungsdicke

Ursache	Lösung
» Durchführung des Schweißens unkorrekt.	» Vorschubgeschwindigkeit beim Schweißen herabsetzen.
» Schweißparameter unkorrekt.	» Schweißstrom erhöhen.
» Elektrode unkorrekt.	» Eine Elektrode mit kleinerem Durchmesser benutzen.
» Nahtvorbereitung unkorrekt.	» Abschrägung vergrößern.
» Masseverbindung unkorrekt.	» Korrekte Masseverbindung ausführen.
	» Siehe Kapitel "Inbetriebnahme".
» Zu große Werkstücke.	» Schweißstrom erhöhen.

Zundereinschlüsse

Ursache	Lösung
» Unvollständiges Entfernen des Zunders.	» Werkstücke vor dem Schweißen sorgfältig reinigen.
» Elektrode mit zu großem Durchmesser.	» Eine Elektrode mit kleinerem Durchmesser benutzen.
» Nahtvorbereitung unkorrekt.	» Abschrägung vergrößern.
» Durchführung des Schweißens unkorrekt.	» Abstand zwischen Elektrode und Werkstück reduzieren.
	» In allen Schweißphasen ordnungsgemäß vorgehen.

Wolfram-Einschlüsse

Ursache	Lösung
» Schweißparameter unkorrekt.	» Schweißstrom verringern.
	» Elektrode mit größerem Durchmesser benutzen.
» Elektrode unkorrekt.	» Immer Produkte und Materialien hochwertiger Qualität benutzen.
	» Elektrode korrekt schleifen.
» Durchführung des Schweißens unkorrekt.	» Kontakte zwischen Elektrode und Schweißbad vermeiden.

Blasen

Ursache	Lösung
» Schutzgas ungenügend.	» Druckluftdurchfluss korrekt regulieren.
	» Prüfen, dass Diffusor und Gasdüse am Brenner in gutem Zustand sind.

Verklebungen

Ursache	Lösung
» Bogenlänge unkorrekt.	» Abstand zwischen Elektrode und Werkstück vergrößern.
	» Schweißspannung erhöhen.

» Schweißparameter unkorrekt.

» Schweißstrom erhöhen.

» Schweißspannung erhöhen.

» Durchführung des Schweißens unkorrekt.

» Brennerneigung erhöhen.

» Zu große Werkstücke.

» Schweißstrom erhöhen.

» Schweißspannung erhöhen.

» Bogendynamik unkorrekt.

» Induktivitätswert des Schweißkreises erhöhen.

Einschnitte an den Rändern

Ursache

» Schweißparameter unkorrekt.

Lösung

» Schweißstrom verringern.

» Eine Elektrode mit kleinerem Durchmesser benutzen.

» Bogenlänge unkorrekt.

» Abstand zwischen Elektrode und Werkstück reduzieren.

» Schweißspannung verringern.

» Durchführung des Schweißens unkorrekt.

» Seitliche Pendelgeschwindigkeit beim Füllen reduzieren.

» Vorschubgeschwindigkeit beim Schweißen herabsetzen.

» Schutzgas ungenügend.

» Gas verwenden, das für die zu schweißenden Werkstoffe geeignet ist.

Oxydationen

Ursache

» Schutzgas ungenügend.

Lösung

» Druckluftdurchfluss korrekt regulieren.

» Prüfen, dass Diffusor und Gasdüse am Brenner in gutem Zustand sind.

Porosität

Ursache

» Vorhandensein von Fett, Lack, Rost oder Schmutz auf den Werkstücken.

Lösung

» Werkstücke vor dem Schweißen sorgfältig reinigen.

» Vorhandensein von Feuchtigkeit im Zusatzwerkstoff.

» Immer Produkte und Materialien hochwertiger Qualität benutzen.

» Zusatzwerkstoff immer in einwandfreiem Zustand halten

» Vorhandensein von Feuchtigkeit im Zusatzwerkstoff.

» Immer Produkte und Materialien hochwertiger Qualität benutzen.

» Zusatzwerkstoff immer in einwandfreiem Zustand halten

» Bogenlänge unkorrekt.

» Abstand zwischen Elektrode und Werkstück reduzieren.

» Schweißspannung verringern.

» Feuchtigkeit im Schweißgas.

» Immer Produkte und Materialien hochwertiger Qualität benutzen.

» Für den einwandfreien Zustand der Gaszuleitung sorgen.

» Schutzgas ungenügend.

» Druckluftdurchfluss korrekt regulieren.

» Prüfen, dass Diffusor und Gasdüse am Brenner in gutem Zustand sind.

» Zu schnelles Erstarren des Schweißbads.

» Vorschubgeschwindigkeit beim Schweißen herabsetzen.

» Werkstücke vorwärmen.

» Schweißstrom erhöhen.

Wärmerisse

Ursache

» Schweißparameter unkorrekt.

Lösung

» Schweißstrom verringern.

» Eine Elektrode mit kleinerem Durchmesser benutzen.

» Vorhandensein von Fett, Lack, Rost oder Schmutz auf den Werkstücken.

» Werkstücke vor dem Schweißen sorgfältig reinigen.

» Vorhandensein von Feuchtigkeit im Zusatzwerkstoff.

» Immer Produkte und Materialien hochwertiger Qualität benutzen.

» Zusatzwerkstoff immer in einwandfreiem Zustand halten

» Durchführung des Schweißens unkorrekt.

» Den korrekten Arbeitsablauf für die zu schweißende Verbindung ausführen.

» Ungleiche Eigenschaften der Werkstücke.

» Vor dem Schweißen ein Puffern ausführen.

Kälterisse

Ursache

- » Vorhandensein von Feuchtigkeit im Zusatzwerkstoff.
- » Besondere Form der zu schweißenden Verbindung.

Lösung

- » Immer Produkte und Materialien hochwertiger Qualität benutzen.
- » Zusatzwerkstoff immer in einwandfreiem Zustand halten
- » Werkstücke vorwärmen.
- » Ein Nachwärmen ausführen.
- » Den korrekten Arbeitsablauf für die zu schweißende Verbindung ausführen.

9. BETRIEBSANWEISUNGEN

DE

9.1 Schweißen mit Mantelelektroden (E-Hand-Schweißen)

Vorbereitung der Schweißkanten

Um gute Schweißergebnisse zu erhalten, ist es in jedem Fall ratsam, an sauberen Teilen zu arbeiten, die frei von Oxidation, Rost oder anderen Schmutzpartikeln sind.

Wahl der Elektrode

Der Durchmesser der Schweißelektrode hängt von der Werkstoffdicke, der Position, dem Nahttyp und von der Vorbereitung des Werkstücks ab. Elektroden mit großem Durchmesser erfordern eine hohe Stromzufuhr woraus eine hohe Wärmezufuhr beim Schweißvorgang resultiert.

Durchmesser erfordern eine hohe Stromzufuhr woraus eine hohe Wärmezufuhr beim Schweißvorgang resultiert.

Art der Ummantelung	Eigenschaften	Verwendung
Rutil	Einfachheit in der alle Positionen	Verwendung
Sauer hohe	Schmelzgesch-windigkeit	ebenflächig
Basisch	gute mechanische Eigenschaften	Verwendung

Wahl des Schweißstromes

Der dem Typ der verwendeten Elektrode entsprechende Schweißstrom-Bereich wird von den Elektrodenherstellern auf der Verpackung der Elektroden angegeben.

Zündung und Aufrechterhaltung des Lichtbogens

Der elektrische Lichtbogen wird durch Reibung der Elektrodenspitze am geerdeten Schweißstück und durch rasches Zurückziehen des Stabes bis zum normalen Schweißabstand nach erfolgter Zündung des Lichtbogens hergestellt. In letzterem Fall wird die Befreiung durch einen seitlichen Ruck herbeigeführt.

Um die Bogenzündung zu verbessern, ist es im Allgemeinen von Vorteil, den Strom anfänglich gegenüber dem Grundschweißstrom zu erhöhen (Hot-Start).

Nach Herstellung des Lichtbogens beginnt die Schmelzung des Mittelstückes der Elektrode, die sich tropfenförmig auf dem Schweißstück ablagert.

Der äußere Mantel der Elektrode wird aufgebraucht und liefert damit das Schutzgas für die Schweißung, die somit eine gute Qualität erreicht.

Um zu vermeiden, dass die Tropfen des geschmolzenen Materials, infolge unbeabsichtigten Annäherns der Elektrode an das Schweißbad, einen Kurzschluss hervorrufen und dadurch das Erlöschen des Lichtbogens verursachen, ist es nützlich, den Schweißstrom kurzzeitig, bis zur Beendigung des Kurzschlusses, zu erhöh

Falls die Elektrode am Werkstück kleben bleibt, ist es nützlich, den Kurzschlussstrom auf das Geringste zu reduzieren (Antisticking).

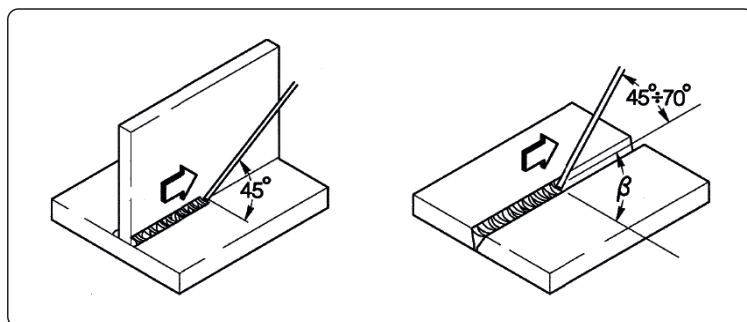

Ausführung der Schweißung

Der Neigewinkel der Elektrode ist je nach der Anzahl der Durchgänge verschieden. Die Bewegung der Elektrode wird normalerweise mit Pendeln und Anhalten an den Seiten der Schweißnaht durchgeführt, wodurch eine übermäßige Ansammlung von Schweißgut in der Mitte vermieden werden soll.

Entfernung der Schlacke

Das Schweißen mit Mantelelektroden erfordert nach jedem Durchgang die Entfernung der Schlacke.

Die Entfernung der Schlacke erfolgt mittels eines kleinen Hammers oder bei leicht bröckelnder Schlacke durch Bürsten.

9.2 WIG-Schweißen (kontinuierlicher Lichtbogen)

Beschreibung

Das Prinzip des WIG-Schweißens (Wolfram-Inert-Gas-Schweißen) basiert auf einem elektrischen Lichtbogen, der zwischen einer nichtschmelzenden Elektrode (reines oder legiertes Wolfram mit einer Schmelztemperatur von ungefähr 3370°C) und dem Werkstück gezündet wird. Eine Inertgas-Atmosphäre (Argon) schützt das Schweißbad.

Um gefährliche Wolframeinschlüsse in der Schweißnaht zu vermeiden, darf die Elektrode nicht mit dem zu schweißenden Stück in Berührung kommen. Aus diesem Grund wird mittels eines HF-Generators eine Entladung erzeugt, der die Zündung des elektrischen Lichtbogens ermöglicht, ohne dass die Elektrode das Werkstück berührt.

Es gibt auch eine weitere Startmöglichkeit mit herabgesetzten Wolframeinschlüssen: der Lift-Start, der keine hohe Frequenz vorsieht, sondern nur eine anfängliche Kurzschlussphase bei Niederstrom zwischen Elektrode und Werkstück. Im Augenblick der Anhebung der Elektrode entsteht der Lichtbogen und die Stromzufuhr erhöht sich bis zur Erreichung des eingestellten Schweißwertes.

Um die Qualität des Schweißnahtendes zu verbessern, ist es äußerst vorteilhaft, das Absinken des Schweißstroms genau kontrollieren zu können und es ist notwendig, dass das Gas auch nach dem Ausgehen des Bogens für einige Sekunden in das Schweißbad strömt.

Unter vielen Arbeitsbedingungen ist es von Vorteil, über 2 voreingestellte Schweißströme zu verfügen, mit der Möglichkeit, von einem auf den anderen übergehen zu können (BILEVEL).

Schweißpolung

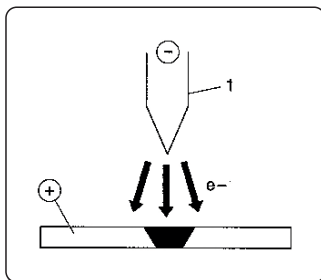

D.C.S.P. (Direct Current Straight Polarity)

Es handelt sich hierbei um die am meisten gebrauchte Polung (direkte Polung); sie bewirkt eine begrenzte Abnutzung der Elektrode (1), da sich 70% der Wärme auf der Anode (Werkstück) ansammelt.

Man erhält ein tiefes und schmales Bad durch hohe Vorschubgeschwindigkeit und daraus resultierender geringer Wärmezufuhr.

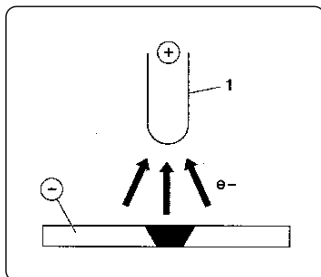

D.C.R.P. (Direct Current Reverse Polarity)

Mit der umgekehrten Polung kann man Legierungen mit einer hitzebeständigen Oxid-Beschichtung, deren wesentliche Eigenschaft eine höhere Schmelztemperatur als jene des Metalls ist, schweißen.

Trotzdem dürfen nicht zu hohe Ströme verwendet werden, da diese eine rasche Abnutzung der Elektrode verursachen würden.

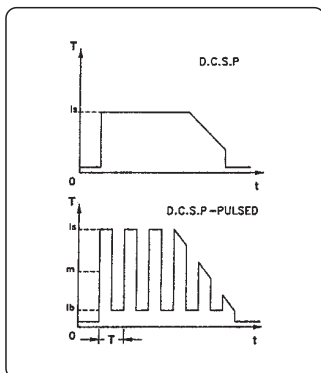

D.C.S.P.-Pulsed (Direct Current Straight Polarity Pulsed)

Die Anwendung eines Pulsstroms erlaubt in besonderen Betriebssituationen eine bessere Kontrolle des Schweißbads in Breite und Tiefe.

Das Schweißbad wird von den Spitzenimpulsen (I_p) gebildet, während der Basisstrom (I_b) den Bogen gezündet hält. Das erleichtert das Schweißen dünner Materialstärken mit geringeren Verformungen, einen besseren Formfaktor und somit eine geringere Gefahr, dass Wärmerisse und gasförmige Einschlüsse auftreten.

Durch Steigern der Frequenz (Mittelfrequenz) erzielt man einen schmaleren, konzentrierteren und stabileren Bogen, was einer weiteren Verbesserung der Schweißqualität bei dünnen Materialstärken gleichkommt.

Merkmale der WIG-Schweißungen

Das WIG-Verfahren ist für das Schweißen sowohl von unlegiertem als auch von Kohlenstoffstahl, für den ersten Schweißgang von Rohren und für Schweißungen, die ein sehr gutes Aussehen haben müssen, besonders geeignet.
Direktpolung erforderlich (D.C.S.P.).

Vorbereitung der Schweißkanten

Eine sorgfältige Reinigung und Nahtvorbereitung ist erforderlich.

Wahl und Vorbereitung der Elektrode

Der Gebrauch von Thoriumwolframelektroden (2% Thorium - rote Farbe) oder anstelle dessen von Zerium- oder Lanthanwolframelektroden mit folgenden Durchmessern wird empfohlen:

Strombereich			Elektrode	
(DC-)	(DC+)	(AC)	Ø	α
3-20 A	-	3-20 A	0,5 mm	30°
15-80 A	-	20-30 A	1,0 mm	30-60°
70-150 A	10-20 A	30-80 A	1,6 mm	60-90°
150-250 A	15-30 A	60-130 A	2,4 mm	90-120°
250-400 A	25-40 A	100-180 A	3,2 mm	120-150°
400-500 A	40-55 A	160-240 A	4,0 mm	150-180°
500-750 A	55-80 A	190-300 A	4,8 mm	150-180°
750-1100 A	80-125 A	325-450 A	6,4 mm	150-180°

Die Elektrode muss wie in der Abbildung gezeigt zugespitzt werden.

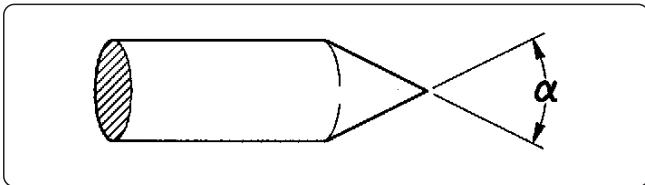

Schweißgut

Die mechanischen Eigenschaften der Schweißstäbe müssen in etwa jenen des Grundmaterials entsprechen.

Aus dem Grundmaterial erhaltene Streifen dürfen nicht verwendet werden, da die von der Verarbeitung herrührenden Unreinheiten die Schweißung wesentlich beeinträchtigen könnten.

Schutzgas

In der Praxis wird fast ausschließlich (99.99 %) reines Argon verwendet.

Strombereich			Gas	
(DC-)	(DC+)	(AC)	Düse	Durchfluss
3-20 A	-	3-20 A	n° 4	5-6 l/min
15-80 A	-	20-30 A	n° 5	6-8 l/min
70-150 A	10-20 A	30-80 A	n° 6	7-10 l/min
150-250 A	15-30 A	60-130 A	n° 7	8-12 l/min
250-400 A	25-40 A	100-180 A	n° 8	10-14 l/min
400-500 A	40-55 A	160-240 A	n° 8	12-16 l/min
500-750 A	55-80 A	190-300 A	n° 10	15-20 l/min
750-1100 A	80-125 A	325-450 A	n° 12	20-25 l/min

10. TECHNISCHE DATEN

DE

Elektrische Eigenschaften			U.M.
Versorgungsspannung U1 (50/60 Hz)	3x230 (±15%)	3x400 (±15%)	Vac
Zmax (@PCC) *	53	53	mΩ
Netzsicherung (träge)	25	16	A
Kommunikation-Bus	DIGITAL	DIGITAL	
Max. Leistungsaufnahme	10.5	10.5	kVA
Max. Leistungsaufnahme	10.1	10.1	kW
Leistungsaufnahme im deaktivierten Zustand	51	51	W
Leistungsfaktor (PF)	0.96	0.96	
Wirkungsgrad (μ)	83	83	%
Cos φ	0.99	0.99	
Max. Stromaufnahme I1max	30.8	15.3	A
Effektivstrom I1eff	18	9	A
Arbeitsbereich	3-270	3-270	A
Leerlaufspannung Uo	80	80	Vdc
Spitzenspannung Up	10.1	10.1	kV

* Diese Anlage entspricht der EN / IEC 61000-3-11.

* Die Anlage entspricht der Norm EN / IEC 61000-3-12, wenn die maximal zulässige Netzimpedanz an der Schnittstelle zum öffentlichen Netz (Netzübergabestelle) kleiner oder gleich dem festgelegten Wert Zmax ist. Wenn sie an ein öffentliches Niederspannungsversorgungsnetz angeschlossen wird, liegt es in der Verantwortung des Installateurs oder Betreibers der Anlage sicherzustellen, dass die Anlage angeschlossen werden darf, indem, falls notwendig, der Netzbetreiber konsultiert wird.

Nutzungsfaktor	3x230V	3x400V	U.M.
Nutzungsfaktor (40°C)			
(X=35%)	270	270	A
(X=60%)	230	230	A
(X=100%)	180	180	A
Nutzungsfaktor (25°C)			
(X=80%)	270	270	A
(X=100%)	240	240	A

Physikalische Eigenschaften			U.M.
Schutzart IP	IP23S		
Isolationsklasse	H		
Abmessungen (LxBxH)	500x190x400		mm
Gewicht	18.8		Kg
Abschnitt netzkabel	4x4		mm ²
Länge des Versorgungskabel	5		m
Konstruktionsnormen	EN IEC 60974-1/A1:2019 EN IEC 60974-3:2019 EN 60974-10/A1:2015		

11. DATENSCHILD

VOESTALPINE BÖHLER WELDING SELCO S.R.L. Via Palladio,19 - ONARA (PADOVA) - ITALY					
URANOS NX 2700 TLH			N°		
		EN 60974-1/A1:2019 60974-3:2019 IEC 60974-10/A1:2015 Class A			
	Up 10.1 kV				
	3A/10.0V - 270A (270A)/20.8V (20.8V)				
	X (40°C)	35%	60%	100%	
	U ₀	I _z	270A (270A)	230A (230A)	180A (180A)
	80V	U ₂	20.8V (20.8V)	19.2V (19.2V)	17.2V (17.2V)
	3A/20.0V - 270A (270A)/30.8V (30.8V)				
	X (40°C)	35%	60%	100%	
	U ₀	I _z	270A (270A)	230A (230A)	180A (180A)
	80V	U ₂	30.8V (30.8V)	29.2V (29.2V)	27.2V (27.2V)
	U ₁ 400V(230V)	I _{1max} 15.3A(30.8A)	I _{1eff} 9A(18A)		
IP 23 S					

DE

12. BEDEUTUNG DER ANGABEN AUF DEM LEISTUNGSSCHILD

1		2			
3		4			
5		6			
7	9	23			
		11			
8	10	12	15	16	17
		13	15A	16A	17A
		14	15B	16B	17B
7	9	11			
		12	15	16	17
8	10	13	15A	16A	17A
		14	15B	16B	17B
		18	19	20	21
22					

- 1 Marke
- 2 Herstellername und -adresse
- 3 Gerätemodell
- 4 Seriennummer
- 5 Symbol des Schweißmaschinentyps
- 6 Hinweis auf die Konstruktionsnormen
- 7 Symbol des Schweißverfahrens
- 8 Symbol für die Schweißmaschinen, die sich zum Betrieb in Räumen mit großer Stromschlaggefahr eignen
- 9 Symbol des Schweißstroms
- 10 Leerlauf-Nennspannung
- 11 Bereich des Nenn-Höchst- und Nenn-Mindestschweißstroms und der entsprechenden Lastspannung
- 12 Symbol für den unterbrochenen Betrieb
- 13 Symbol des Nenn-Schweißstroms
- 14 Symbol der Nenn-Schweißspannung
- 15 Werte für den unterbrochenen Betrieb
- 16 Werte für den unterbrochenen Betrieb
- 17 Werte für den unterbrochenen Betrieb
- 15A Werte des Nenn-Schweißstroms
- 16A Werte des Nenn-Schweißstroms
- 17A Werte des Nenn-Schweißstroms
- 15B Werte der üblichen Lastspannung
- 16B Werte der üblichen Lastspannung
- 17B Werte der üblichen Lastspannung
- 18 Symbol der Stromversorgung
- 19 Versorgungs-Nennspannung
- 20 Maximale Nennstromaufnahme
- 21 Maximale Effektivstromaufnahme
- 22 Schutzart
- 23 Spitzenspannung Nennwert

CE EU-Konformitätserklärung
 EAC EAC-Konformitätserklärung
 UKCA UKCA-Konformitätserklärung

DÉCLARATION DE CONFORMITÉ UE

Le constructeur

voestalpine Böhler Welding Selco S.r.l. - Via Palladio, 19 - 35019 Onara di Tombolo (PD) - ITALY
Tél. +39 049 9413/111 - Fax +39 049 9413/311 - www.voestalpine.com/welding

déclare sous sa seule responsabilité que le produit suivant:

URANOS NX 2700 TLH **55.07.042**
55.07.043

est conforme aux directives EU:

2014/35/EU LOW VOLTAGE DIRECTIVE

2014/30/EU EMC DIRECTIVE

2011/65/EU RoHS DIRECTIVE

2019/1784/EU EcoDesign

2009/125/EU EcoDesign

et que les normes harmonisées suivantes ont été appliquées:

EN IEC 60974-1/A1:2019	WELDING POWER SOURCE
EN IEC 60974-3:2019	ARC STRIKING AND STABILIZING DEVICES
EN 60974-10/A1:2015	ELECTROMAGNETIC COMPATIBILITY REQUIREMENTS

La documentation certifiant le respect des directives sera tenue à disposition pour les inspections chez le fabricant susmentionné.

Toute intervention ou modification non autorisée par voestalpine Böhler Welding Selco S.r.l. annulera la validité de cette déclaration.

Onara di Tombolo, 01/07/2024

voestalpine Böhler Welding Selco s.r.l.



Mirco Frasson **Ivo Bonello**

Managing Directors

INDEX GENERAL

1. AVERTISSEMENT	116
1.1 Environnement d'utilisation	116
1.2 Protection individuelle et de l'entourage	116
1.3 Protection contre les fumées et les gaz	117
1.4 Prévention contre le risque d'incendie et d'explosion	118
1.5 Prévention dans l'emploi de bouteilles de gaz	118
1.6 Protection contre les décharges électriques	118
1.7 Champs électromagnétiques et interférences	118
1.8 Degré de protection IP	120
1.9 Élimination	120
2. INSTALLATION	120
2.1 Mode de soulèvement, de transport et de déchargement	120
2.2 Installation de l'appareil	120
2.3 Branchement et raccordement	120
2.4 Mise en service	121
3. PRÉSENTATION DE L'APPAREIL	122
3.1 Panneau arrière	122
3.2 Panneau prises	122
3.3 Panneau de commande frontal	123
4. UTILISATION DE L'INSTALLATION	124
4.1 Écran de démarrage	124
4.2 Écran principal	124
4.3 Écran principal du procédé MMA	124
5. MENU SET UP	128
5.1 Set up et paramétrage des paramètres	128
5.2 Procédures spécifiques d'utilisation des paramètres	136
6. ENTRETIEN	140
6.1 Contrôles périodiques sur le générateur	140
6.2 Responsabilité	140
7. CODES D'ALARMES	140
8. DIAGNOSTIC ET SOLUTIONS	142
9. MODE D'EMPLOI	145
9.1 Soudage à l'électrode enrobée (MMA)	145
9.2 Soudage TIG (arc en soudure continue)	146
10. CARACTÉRISTIQUES TECHNIQUES	148
11. PLAQUE DONNÉES	149
12. SIGNIFICATION DE LA PLAQUE DES DONNÉES	149
13. SCHÉMA	438
14. CONNECTEURS	440
15. LISTE DE PIÈCES DÉTACHÉES	441

SYMBOLOLOGIE



Avertissement



Interdictions



Obligations



Indications générales

1. AVERTISSEMENT



Avant de commencer toute opération, assurez-vous d'avoir bien lu et bien compris ce manuel.

N'apportez pas de modification et n'effectuez pas d'opération de maintenance si elles ne sont pas indiquées dans ce manuel. Le fabricant n'est pas responsable des dommages causés aux personnes ou aux objets en cas de non-respect ou de mise en pratique incorrecte des instructions de ce manuel.

Les Instructions de service doivent être conservées en permanence sur le lieu d'utilisation de l'appareil. En complément des présentes instructions de service, les règles générales et locales en vigueur concernant la prévention des accidents et la protection de l'environnement doivent être respectées.

voestalpine Böhler Welding Selco S.r.l. se réserve le droit d'apporter des modifications à tout moment et sans aucun préavis.

Les droits de traduction, de reproduction totale ou partielle quels que soient les moyens (y compris les photocopies, les films et les microfilms) sont réservés et interdits sans l'autorisation écrite de voestalpine Böhler Welding Selco S.r.l.

Ce qui est reporté ci-dessous est très important et donc nécessaire afin que la garantie puisse être valable.

Le fabricant décline toute responsabilité si l'opérateur ne respecte pas les indications.



Toutes les personnes concernées par la mise en service, l'utilisation, la maintenance et la remise en état de l'appareil doivent:

- posséder les qualifications correspondantes
- avoir des connaissances en soudage
- lire attentivement et suivre avec précision les prescriptions des présentes Instructions de service

Prière de consulter du personnel qualifié en cas de doute ou de problème sur l'utilisation de l'installation, même si elle n'est pas décrite ici.

1.1 Environnement d'utilisation



Chaque installation ne doit être utilisée que dans le but exclusif pour lequel elle a été conçue, de la façon et dans les limites prévues sur la plaque signalétique et/ou dans ce manuel, selon les directives nationales et internationales relatives à la sécurité. Un usage autre que celui expressément déclaré par le fabricant doit être considéré comme inapproprié et dangereux et décharge ce dernier de toute responsabilité.



Cet appareil doit être utilisé exclusivement dans un but professionnel, dans un environnement industriel. Le fabricant n'est pas responsable des dommages causés en cas d'usage domestique.



L'installation doit être utilisée dans un local dont la température est comprise entre -10 et +40°C (entre +14 et +104°F).

L'installation doit être transportée et stockée dans un local dont la température est comprise entre -25 et +55°C (entre -13 et 131°F).

L'installation doit être utilisée dans un local sans poussière, ni acide, ni gaz ou autres substances corrosives.

L'installation ne doit pas être utilisée dans un local dont le taux d'humidité dépasse 50% à 40°C (104°F).

L'installation ne doit pas être utilisée dans un local dont le taux d'humidité dépasse 90% à 20°C (68°F).

L'installation ne doit pas être utilisée à une altitude supérieure à 2000 m au dessus du niveau de la mer (6500 pieds).



Ne pas utiliser cet appareil pour dégeler des tuyaux.

Ne pas utiliser cet appareil pour recharger des batteries et/ou des accumulateurs.

Ne pas utiliser cet appareil pour démarrer des moteurs.

1.2 Protection individuelle et de l'entourage



Le procédé de soudage constitue une source nocive de radiations, de bruit, de chaleur et d'émanations gazeuses. Installer une cloison de séparation ignifuge afin de protéger la zone de soudage des rayons, projections et déchets incandescents. Rappeler aux personnes dans la zone de soudage de ne fixer ni les rayons de l'arc, ni les pièces incandescentes et de porter des vêtements de protection appropriés.



Porter des vêtements de protection afin de protéger la peau contre les rayons de l'arc, les projections ou contre le métal incandescent. Les vêtements portés doivent couvrir l'ensemble du corps et:

- être en bon état
- être ignifuges
- être isolants et secs
- coller au corps et ne pas avoir de revers



Toujours porter des chaussures conformes aux normes, résistantes et en mesure de bien isoler de l'eau.



Toujours utiliser des gants conformes aux normes et en mesure de garantir l'isolation électrique et thermique.



Utiliser un masque avec des protections latérales pour le visage et un filtre de protection adéquat pour les yeux (au moins NR10 ou supérieur).



Toujours porter des lunettes de sécurité avec des coques latérales, particulièrement lors du nettoyage manuel ou mécanique des cordons de soudage.



Ne pas utiliser de lentilles de contact!



Utiliser un casque contre le bruit si le procédé de soudage atteint un niveau de bruit dangereux. Si le niveau de bruit dépasse les limites prescrites par la loi, délimiter la zone de travail et s'assurer que les personnes qui y accèdent portent un casque ou des bouchons de protection.



Toujours laisser les panneaux latéraux fermés durant les opérations de soudage. L'installation ne doit absolument pas être modifiée.



Éviter de toucher les pièces qui viennent d'être soudées car la forte chaleur pourrait provoquer des brûlures graves. Suivre également toutes les précautions indiquées plus haut en fin de soudage car des résidus en cours de refroidissement pourraient se détacher des pièces usinées.



S'assurer que la torche est froide avant d'intervenir dessus ou d'effectuer une opération d'entretien quelconque.



S'assurer que le groupe de refroidissement est éteint avant de déconnecter les tuyaux de circulation du liquide réfrigérant. Le liquide chaud en sortie pourrait provoquer des brûlures graves.



Avoir à disposition une trousse de secours.
Ne pas sous-estimer les brûlures ou les blessures.



Avant de quitter le poste de travail, sécuriser la zone afin d'empêcher tout risque d'accident ou de dommages aux personnes ou aux biens.

1.3 Protection contre les fumées et les gaz



Les fumées, les gaz et les poussières produits par le procédé de soudage peuvent être nocifs pour la santé.

Les fumées qui se dégagent durant le processus de soudage peuvent, dans certaines circonstances, provoquer le cancer ou nuire au fœtus chez les femmes enceintes.

- Veiller à ne pas être en contact avec les gaz et les fumées de soudage.
- Prévoir une ventilation adéquate, naturelle ou forcée, dans la zone de travail.
- En cas d'aération insuffisante, utiliser un masque à gaz spécifique.
- En cas d'opérations de soudage dans des locaux de petites dimensions, il est conseillé de faire surveiller l'opérateur par un collègue situé à l'extérieur.
- Ne pas utiliser d'oxygène pour la ventilation.
- S'assurer que l'aspiration est efficace en contrôlant régulièrement si les gaz nocifs ne dépassent pas les valeurs admises par les normes de sécurité.
- La quantité et le niveau de risque des fumées produites dépendent du métal de base utilisé, du métal d'apport et des substances éventuelles utilisées pour nettoyer et dégraisser les pièces à souder. Suivre attentivement les instructions du fabricant et les fiches techniques correspondantes.
- Ne pas effectuer d'opérations de soudage à proximité d'ateliers de dégraissage ou de peinture.
- Placer les bouteilles de gaz dans des endroits ouverts ou dans un local bien aéré.

1.4 Prévention contre le risque d'incendie et d'explosion



Le procédé de soudage peut causer des incendies et/ou des explosions.

- Débarrasser la zone de travail et ses abords de tous les matériaux et objets inflammables ou combustibles.
- Les matériaux inflammables doivent se trouver à au moins 11 mètres (35 pieds) de la zone de soudage et être entièrement protégés.
- Les projections et les particules incandescentes peuvent facilement être projetées à distance, même à travers des fissures. Veiller à ce que les personnes et les biens soient à une distance suffisante de sécurité.
- Ne pas effectuer de soudures sur ou à proximité de récipients sous pression.
- Ne pas effectuer d'opérations de soudage ou de découpage sur des containers ou des tubes fermés. Faire très attention au moment de souder des tuyaux ou des containers, même ouverts, vidés et nettoyés soigneusement. Des résidus de gaz, de carburant, d'huile ou autre pourraient provoquer une explosion.
- Ne pas souder dans une atmosphère contenant des poussières, des gaz ou des vapeurs explosives.
- S'assurer, en fin de soudage, que le circuit sous tension ne peut pas toucher accidentellement des pièces connectées au circuit de masse.
- Installer à proximité de la zone de travail un équipement ou un dispositif anti-incendie.

1.5 Prévention dans l'emploi de bouteilles de gaz



Les bouteilles de gaz inertes contiennent du gaz sous pression et peuvent exploser si les conditions requises en matière de transport, de conservation et d'utilisation ne sont pas garanties.

- Les bouteilles doivent être rangées verticalement contre le mur ou contre un support et être maintenues par des moyens appropriés pour qu'elles ne tombent pas et éviter des chocs mécaniques accidentels.
- Visser le capuchon pour protéger la valve durant le transport ou la mise en service et chaque fois que les opérations de soudage sont terminées.
- Ne pas laisser les bouteilles au soleil et ne pas les exposer aux gros écarts de températures trop élevées ou trop extrêmes. Ne pas exposer les bouteilles à des températures trop basses ou trop élevées.
- Veiller à ce que les bouteilles ne soient pas en contact avec une flamme, avec un arc électrique, avec une torche ou une pince porte-électrodes, ni avec des projections incandescentes produites par le soudage.
- Garder les bouteilles loin des circuits de soudage et des circuits électriques en général.
- Éloigner la tête de l'orifice de sortie du gaz au moment d'ouvrir la valve de la bouteille.
- Toujours refermer la valve de la bouteille quand les opérations de soudage sont terminées.
- Ne jamais souder une bouteille de gaz sous pression.
- Ne jamais relier une bouteille d'air comprimé directement au réducteur de pression de la machine! Si la pression dépasse la capacité du réducteur, celui-ci pourrait exploser!

1.6 Protection contre les décharges électriques



Une décharge électrique peut être mortelle.

- Éviter de toucher les parties normalement sous tension à l'intérieur ou à l'extérieur de l'installation de soudage quand cette dernière est alimentée (les torches, les pinces, les câbles de masse, les électrodes, les fils, les galets et les bobines sont branchés au circuit de soudage).
- Garantir l'isolation de l'installation et de l'opérateur en utilisant des sols et des plans secs et suffisamment isolés de la terre.
- S'assurer que l'installation soit connectée correctement à une fiche et à un réseau muni d'un conducteur de mise à la terre.
- Ne pas toucher en même temps deux torches ou deux pinces porte-électrodes.
- Interrompre immédiatement les opérations de soudage en cas de sensation de décharge électrique.



Le système d'amorçage et de stabilisation d'arc est conçu pour des opérations manuelles ou guidées mécaniquement.



L'augmentation de la longueur des câbles de soudage ou de torche de plus de 8 m augmentera le risque de choc électrique.

1.7 Champs électromagnétiques et interférences



Le passage du courant dans les câbles à l'intérieur et à l'extérieur de l'installation crée un champ électromagnétique à proximité de cette dernière et des câbles de soudage.

- Les champs électromagnétiques peuvent avoir des effets (jusqu'ici inconnus) sur la santé de ceux qui y sont exposés pendant un certain temps.
- Les champs électromagnétiques peuvent interférer avec d'autres appareils tels que les stimulateurs cardiaques ou les appareils acoustiques.



Les personnes qui portent un stimulateur cardiaque (pacemaker) ou un appareil auditif doivent consulter le médecin avant d'effectuer des opérations de soudure à l'arc.

1.7.1 Classification CEM selon la norme: EN 60974-10/A1:2015.

Classe
B

Los dispositivos de clase B cumplen con los requisitos de compatibilidad electromagnética en entornos industriales y residenciales, incluyendo las áreas residenciales en las que la energía eléctrica se suministra desde un sistema público de baja tensión.

Classe
A

Los dispositivos de clase A no están destinados al uso en áreas residenciales en las que la energía eléctrica se suministra desde un sistema público de baja tensión. Il pourrait être difficile d'assurer la compatibilité électromagnétique d'appareils de classe A dans de tels environnements, en raison de perturbations par rayonnement ou conduction.

Pour plus d'informations, consultez le chapitre: PLAQUE DONNÉES ou CARACTÉRISTIQUES TECHNIQUES.

1.7.2 Installation, utilisation et évaluation de la zone

Ce matériel a été fabriqué conformément aux dispositions relatives à la norme harmonisée EN 60974-10/A1:2015 et est considéré comme faisant partie de la "CLASSE A". Cet appareil doit être utilisé exclusivement dans un but professionnel, dans un environnement industriel. Le fabricant n'est pas responsable des dommages causés en cas d'usage domestique.



L'utilisateur, qui doit être un expert dans le domaine, est responsable en tant que tel de l'installation et de l'utilisation de l'appareil selon les instructions du constructeur. Si des perturbations électromagnétiques apparaissent, il est de la responsabilité de l'utilisateur de résoudre le problème en demandant conseil au service après-vente du constructeur.



Dans tous les cas, les perturbations électromagnétiques doivent être réduites de manière à ne plus représenter une gêne.



Avant l'installation de l'appareil, l'utilisateur devra évaluer les problèmes électromagnétiques potentiels qui pourraient survenir aux abords de la zone de travail et en particulier sur la santé des personnes situées à proximité (personnes portant un pacemaker ou un appareil auditif).

1.7.3 Exigences de l'alimentation de secteur

Le courant primaire peut entraîner des distortions du réseau sur les appareils de forte puissance. Aussi les restrictions et exigences de connexion sur les impédances maximum autorisées du réseau (Z_{max}) ou sur la capacité d'alimentation minimum (S_{sc}) requise au point d'interface du réseau public (point de couplage commun, PCC), peuvent s'appliquer à quelques modèles d'appareils (se reporter aux caractéristiques techniques). Dans ce cas, il est de la responsabilité de l'installateur ou de l'utilisateur de l'appareil de s'assurer, en consultant l'opérateur de réseau de distribution si nécessaire, que l'appareil peut être connecté. En cas d'interférence, il pourrait être nécessaire de prendre des précautions supplémentaires, telles que le filtrage de l'alimentation de secteur.

Il faut également envisager la possibilité de blinder le câble d'alimentation.

Pour plus d'informations, consultez le chapitre: CARACTÉRISTIQUES TECHNIQUES.

1.7.4 Précautions concernant les câbles

Se conformer aux règles suivantes pour réduire les effets des champs électromagnétiques:

- Enrouler l'un avec l'autre et fixer, quand cela est possible, le câble de masse et le câble de puissance.
- Ne jamais enrouler les câbles autour du corps.
- Ne pas se placer entre le câble de masse et le câble de puissance (les mettre tous les deux du même côté).
- Les câbles doivent rester les plus courts possible, être placés proche l'un de l'autre à même le sol ou près du niveau du sol.
- Placer l'installation à une certaine distance de la zone de soudage.
- Les câbles ne doivent pas être placés à proximité d'autres câbles.

1.7.5 Branchement equipotentiel

Le branchement à la masse de tous les composants métalliques de l'installation de soudage (découpage) et adjacents à cette installation doit être envisagé. Respecter les normes nationales concernant la branchement equipotentiel.

1.7.6 Mise a la terre de la pièce à souder

Quand la pièce à souder n'est pas reliée à la terre, pour des motifs de sécurité électrique ou à cause de son encombrement et de sa position, un branchement reliant la pièce à la terre pourrait réduire les émissions. Il faut veiller à ce que la mise à la terre de la pièce à souder n'augmente pas le risque d'accident pour les utilisateurs ou de dommages sur d'autres appareils électriques. Respecter les normes nationales concernant la mise à la terre.

1.7.7 Blindage

Le blindage sélectif d'autres câbles et appareils présents à proximité de la zone peut réduire les problèmes d'interférences.

Le blindage de toute l'installation de soudage peut être envisagé pour des applications spéciales.

1.8 Degré de protection IP



IP23S

- Boîtier de protection contre l'accès aux parties dangereuses par un doigt et contre des corps solides étrangers ayant un diamètre supérieur/égal à 12.5 mm.
- Grille de protection contre une pluie tombant à 60°.
- Boîtier protégé contre les effets nuisibles dus à la pénétration d'eau lorsque les parties mobiles de l'appareil ne sont pas encore en fonctionnement.

1.9 Élimination



Ne pas éliminer les équipements électriques avec les déchets ménagers !

Conformément à la Directive européenne 2012/19/UE relative aux déchets d'équipements électriques et électroniques et à sa mise en œuvre conformément aux lois nationales, les équipements électriques qui ont atteint la fin de leur cycle de vie doivent être collectés séparément et envoyés à un centre de récupération et d'élimination. Le propriétaire de l'équipement doit identifier les centres de collecte agréés en se renseignant auprès des autorités locales. L'application de la Directive Européenne permettra de respecter l'environnement et la santé des êtres humains.

» Pour plus d'informations, consulter le site.

2. INSTALLATION



L'installation ne peut être effectuée que par du personnel expérimenté et agréé par le constructeur.



Pendant l'installation, s'assurer que le générateur est déconnecté du réseau.



Il est interdit de connecter, en série ou en parallèle, des générateurs.

2.1 Mode de soulèvement, de transport et de déchargement

- L'appareil est équipé d'une poignée permettant le portage à la main.



Ne pas sous-évaluer le poids de l'installation, se reporter aux caractéristiques techniques.
Ne pas faire passer ou arrêter la charge suspendue au-dessus de personnes ou d'objets.
Ne pas laisser tomber le matériel ou ne pas créer de pression inutile sur l'appareil.

2.2 Installation de l'appareil



Observer les règles suivantes:

- Réserver un accès facile aux commandes et aux connexions de l'appareil.
- Ne pas installer l'appareil dans des locaux de petites dimensions.
- Ne jamais placer la machine sur un plan incliné de plus de 10° par rapport à l'horizontale.
- Installer le matériel dans un endroit sec, propre et avec une aération appropriée.
- Mettre l'installation à l'abri de la pluie battante et ne pas l'exposer aux rayons du soleil.

2.3 Branchement et raccordement



Le générateur est doté d'un câble d'alimentation pour le branchement au réseau.

L'appareil peut être alimenté en:

- 230V triphasé
- 400V triphasé

Le fonctionnement de l'appareil est garanti pour des tensions avec une tolérance de $\pm 15\%$ par rapport à la valeur nominale.



Contrôler la tension sélectionnée et les fusibles AVANT de brancher la machine au réseau pour éviter des dommages aux personnes ou à l'installation. Contrôler également si le câble est branché à une prise munie d'un contact de terre.



L'appareil peut être alimenté par groupe électrogène à condition que celui-ci garantisse une tension d'alimentation stable entre $\pm 15\%$ par rapport à la valeur de tension nominale déclarée par le fabricant, dans toutes les conditions de fonctionnement possibles et à la puissance maximale pouvant être fournie par le générateur. Il est généralement conseillé d'utiliser un groupe électrogène dont la puissance est égale à 2 fois celle du générateur s'il est monophasé et à 1.5 fois s'il est triphasé. Il est conseillé d'utiliser un groupe électrogène à contrôle électronique.



L'installation doit être branchée correctement à la terre pour garantir la sécurité des utilisateurs. Le conducteur (jaune - vert) fourni pour la mise à la terre du câble d'alimentation doit être branché à une fiche munie d'un contact de terre. Ce fil jaune/vert ne doit JAMAIS être utilisé avec d'autres conducteurs de tension. S'assurer que la mise à la terre est bien présente dans l'installation utilisée et vérifier le bon état des prises de courant. Utiliser exclusivement des fiches homologuées conformes aux normes de sécurité.



L'installation électrique doit être réalisée par un personnel technique qualifié, et conformément aux lois du pays dans lequel est effectuée cette opération.

2.4 Mise en service

2.4.1 Raccordement pour le soudage MMA



Le branchement décrit ci-dessous donne comme résultat une soudure avec une polarité inverse. Inverser le branchement pour obtenir une soudure avec une polarité directe.

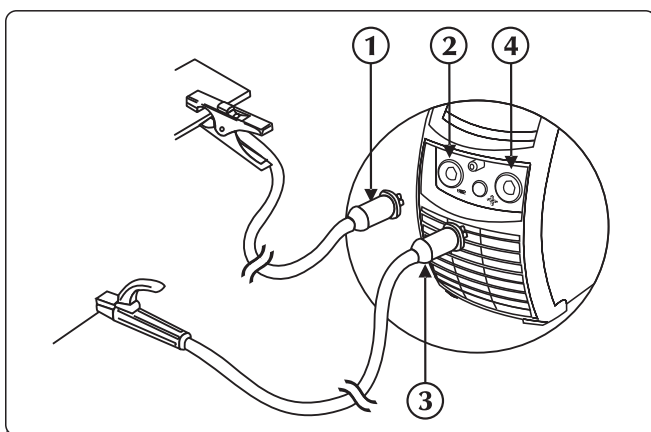

- ① Connecteur de pince de terre
- ② Raccord de puissance négative (-)
- ③ Connecteur de pince porte-électrode
- ④ Raccord de puissance positive (+)

- ▶ Brancher le connecteur du câble de la pince de masse à la prise négative (-) du générateur. Introduire la prise et tourner dans le sens des aiguilles d'une montre jusqu'à ce que les parties soient bien fixées.
- ▶ Brancher le connecteur du câble de la pince porte-électrode à la prise positive(+) du générateur. Introduire la prise et tourner dans le sens des aiguilles d'une montre jusqu'à ce que les parties soient bien fixées.

2.4.2 Raccordement pour le soudage TIG

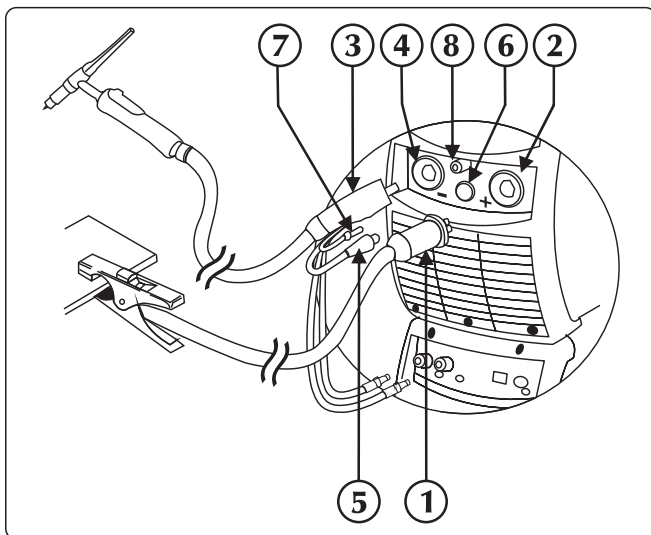

- ① Connecteur de pince de terre
- ② Raccord de puissance positive (+)
- ③ Raccord torche TIG
- ④ Prise de torche
- ⑤ Câble d'interface de torche
- ⑥ Connecteur
- ⑦ Tuyau gaz de torche
- ⑧ Raccord du gaz

- ▶ Brancher le connecteur de câble de la pince de masse à la prise positive (+) du générateur. Introduire la prise et tourner dans le sens des aiguilles d'une montre jusqu'à ce que les parties soient bien fixées.
- ▶ Brancher le raccord de la torche TIG à la prise de la torche du générateur. Introduire la prise et tourner dans le sens des aiguilles d'une montre jusqu'à ce que les parties soient bien fixées.
- ▶ Connecter le câble d'interface de torche au connecteur approprié.
- ▶ Conecte el tubo de gas de la antorcha a la conexión/unión apropiada.
- ▶ Relier le tuyau du liquide de refroidissement de la torche (symbole rouge) au raccord rapide d'entrée (symbole rouge) du refroidisseur.
- ▶ Relier le tuyau du liquide de refroidissement de la torche (symbole bleu) au raccord rapide (symbole bleu) de sortie du refroidisseur.

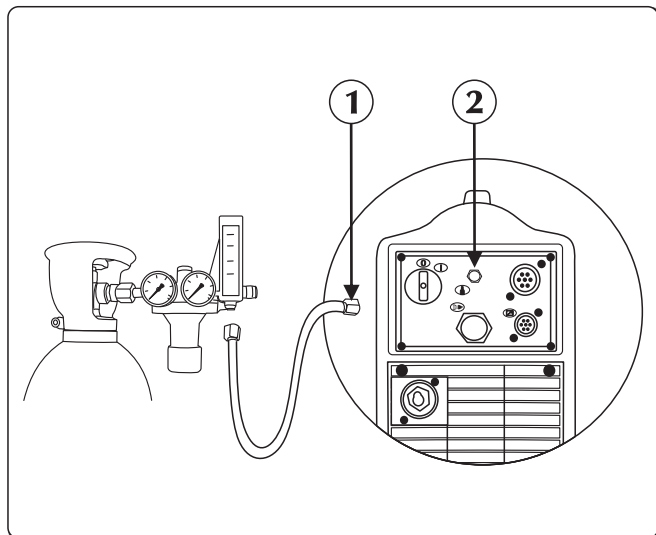

- ① Tuyau gaz
- ② Raccord du gaz

► Relier le tuyau du gaz provenant de la bouteille au raccord arrière du gaz. Régler le débit du gaz de 5 à 15 l/min.

3. PRÉSENTATION DE L'APPAREIL

3.1 Panneau arrière

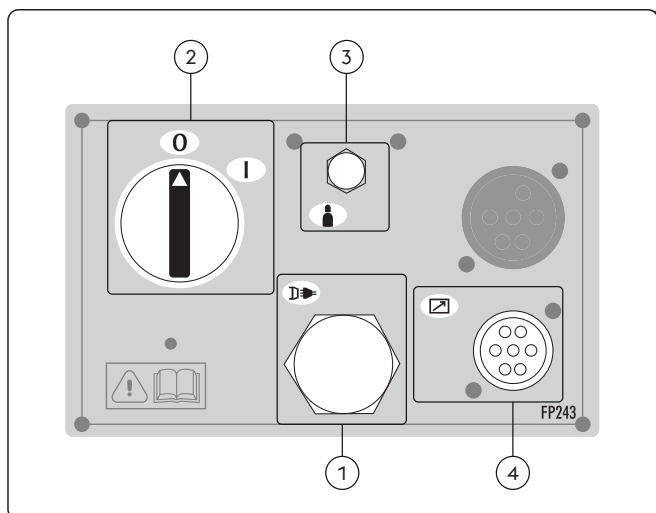

- ① Câble d'alimentation
Il permet d'alimenter l'installation en la branchant au secteur.
- ② Interrupteur Marche/arrêt
Commande l'allumage électrique du système. Il a deux positions, "0" éteint, "I" allumé.
- ③ Raccord gaz
- ④ Entrée du câble d'interface CAN-BUS (RC, RI...)

3.2 Panneau prises

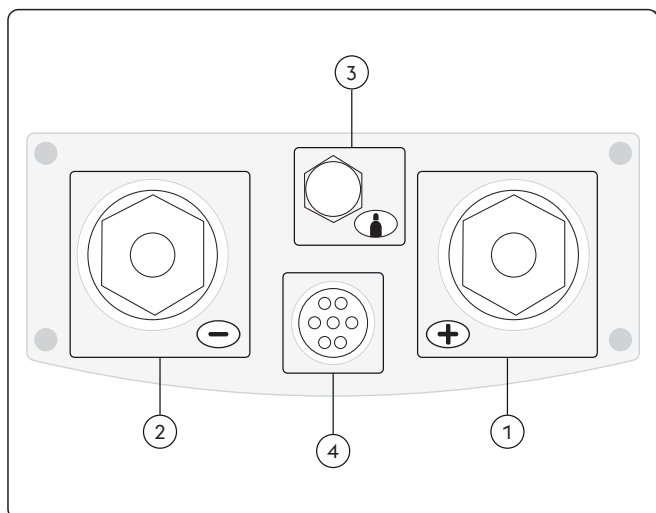





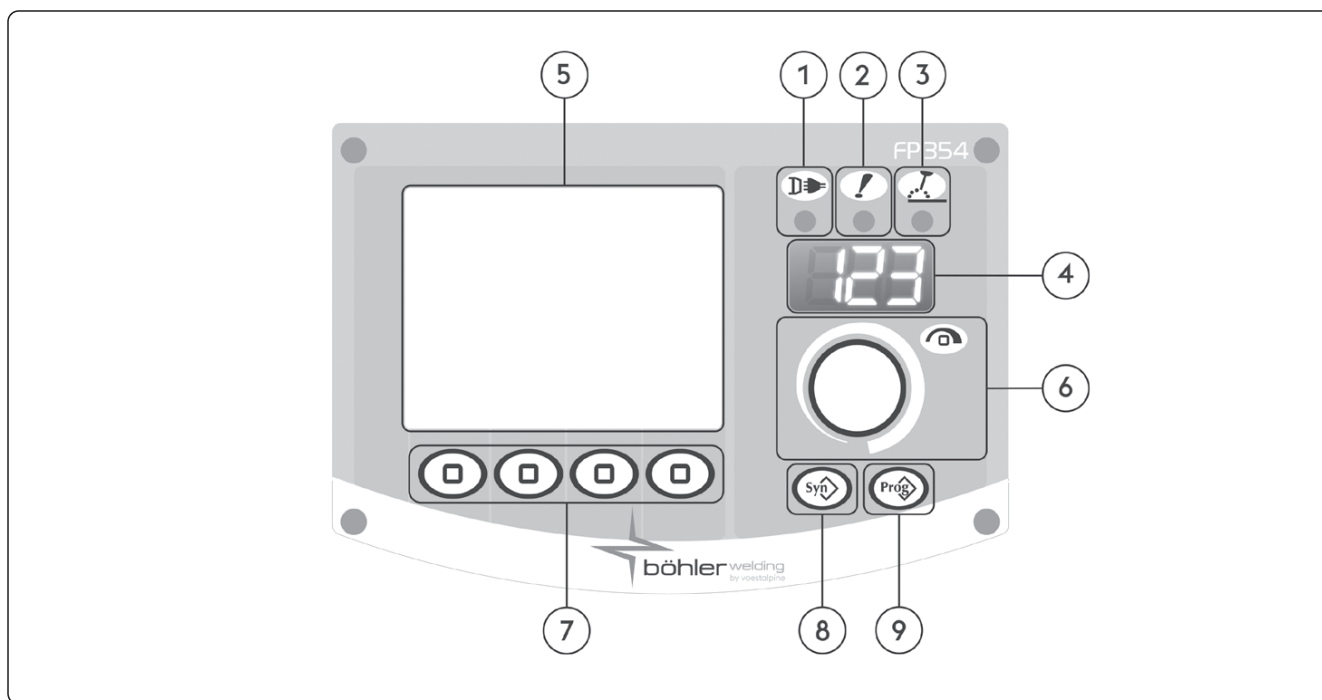



- ① Raccord de puissance positive (+)
Processus MMA: Connexion torche d'électrode
Processus TIG: Connexion câble de masse
- ② Raccord de puissance négative (-)
Processus MMA: Connexion câble de masse
Processus TIG: Connexion de la torche
- ③ Raccord gaz
- ④ Entrée du câble de signal (torche TIG)

3.3 Panneau de commande frontal



FR

- ①  **LED d'alimentation**
Indique que le générateur est connecté au réseau et qu'il est sous tension.
- ②  **LED d'alarme générale**
Indique l'intervention possible des systèmes de protection, tels que la protection thermique.
- ③  **LED de puissance active**
Indique la présence de tension sur les connexions de sortie du générateur.
- ④  **Affichage des données**
Permet l'affichage des différents paramètres de soudage lors de la mise en route, des réglages, la lecture de l'intensité et de la tension pendant le soudage, ainsi que la codification des défauts.
- ⑤  **LCD display**
Permet l'affichage des différents paramètres de soudage lors de la mise en route, des réglages, la lecture de l'intensité et de la tension pendant le soudage, ainsi que la codification des défauts.
Permet l'affichage instantané de toutes les opérations.
- ⑥  **Bouton de réglage principal**
Permet le réglage permanent du courant de soudage.
Permet l'accès au menu et la sélection et le réglage des paramètres de soudage.
- ⑦  **Touches de fonction**
Permet la sélection des diverses fonctions du système:
- Proceso de soldadura
- Procédures de soudage
- Courant de pulsation
- Mode graphique
- ⑧  **Touche non utilisée**
- ⑨  **Touche job**
Permet l'enregistrement et la gestion de 240 job qui peuvent être personnalisés par l'opérateur.

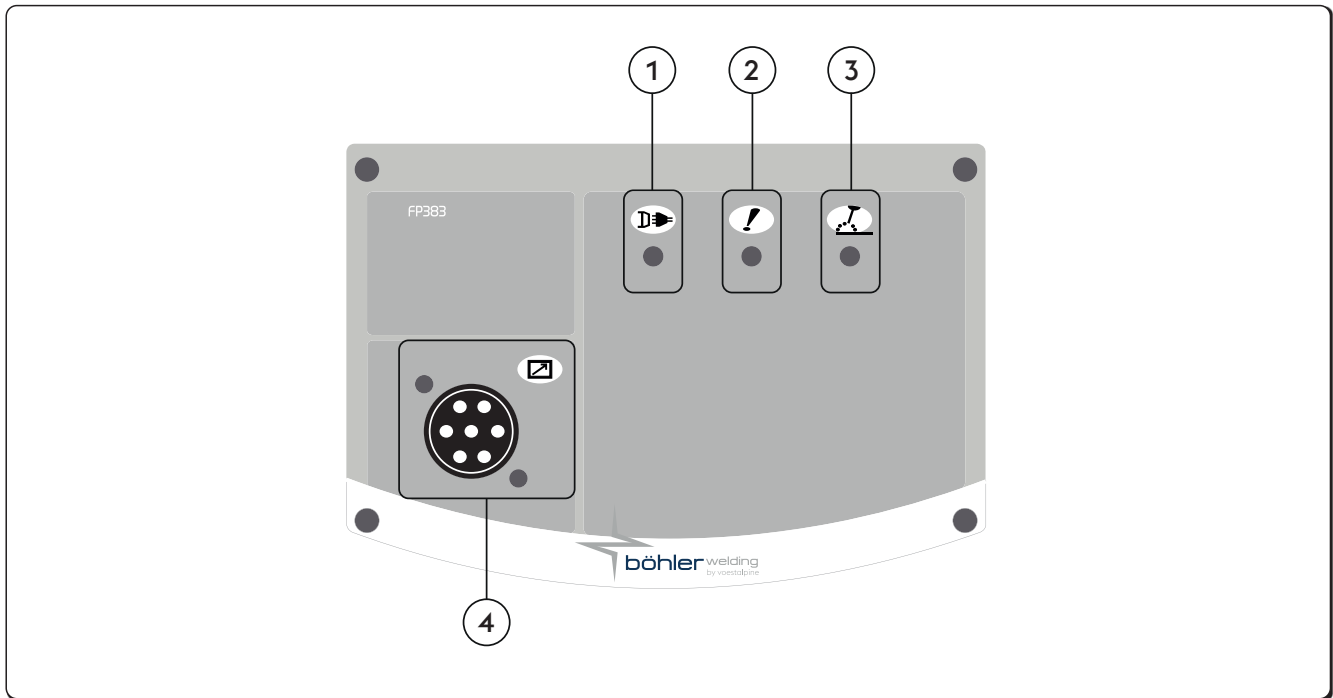

- ① **LED d'alimentation**
Indique que le générateur est connecté au réseau et qu'il est sous tension.
- ② **LED d'alarme générale**
Indique l'intervention possible des systèmes de protection, tels que la protection thermique.
- ③ **LED de puissance active**
Indique la présence de tension sur les connexions de sortie du générateur.
- ④ **Entrée du câble d'interface CAN-BUS (RC, RI...)**

4. UTILISATION DE L'INSTALLATION

4.1 Ecran de démarrage

À l'allumage, le système effectue une série de vérifications pour garantir son bon fonctionnement et celui de tous les dispositifs connectés. A ce stade, le test gaz est également activé pour vérifier la connexion correcte du système d'alimentation gaz.

4.2 Ecran principal

Permet la gestion de l'équipement et du procédé de soudage, en affichant les réglages principaux.

4.3 Écran principal du procédé MMA

- ① Lectures des paramètres
- ② Paramètres de soudage
- ③ Fonctions

Lectures des paramètres

Durant l'opération de soudage, les valeurs de tension et courant réels sont affichées sur l'afficheur LCD.

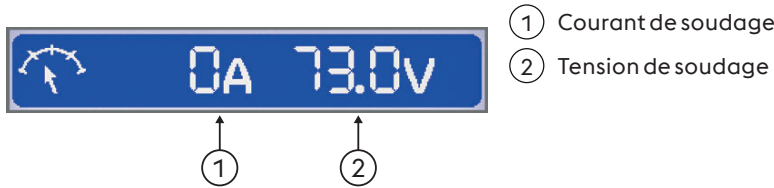

Paramètres de soudage

► Sélectionner le paramètre choisi en appuyant sur le bouton de réglage.

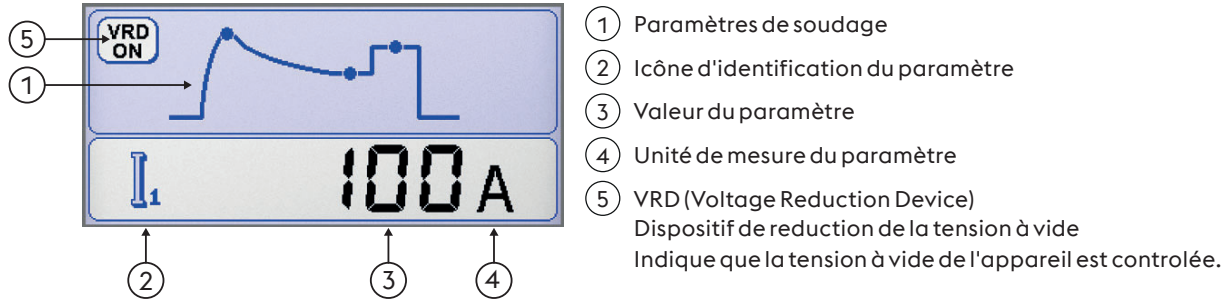

Fonctions

Permet la sélection des plus importantes fonctions de procédé et de mode de soudage.

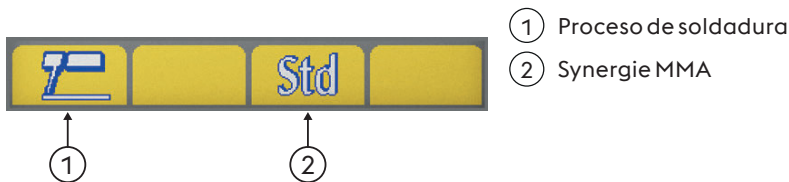

Proceso de soldadura

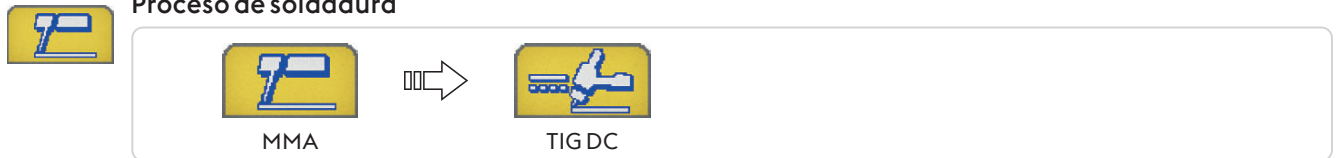

Synergie MMA

Pour saisir la meilleure dynamique d'arc en sélectionnant le type d'électrode utilisée.

La sélection de la bonne dynamique d'arc permet de bénéficier de générateur pour obtenir les meilleures performances de soudage.

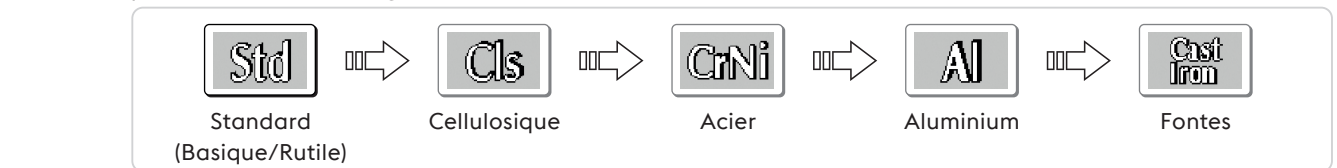

La soudabilité parfaite de l'électrode utilisée n'est pas garantie.

La soudabilité dépend de la qualité des consommables et de leur stockage, des conditions de soudage et d'utilisation, des applications possibles nombreuses..

4.4 Écran principal du procédé TIG

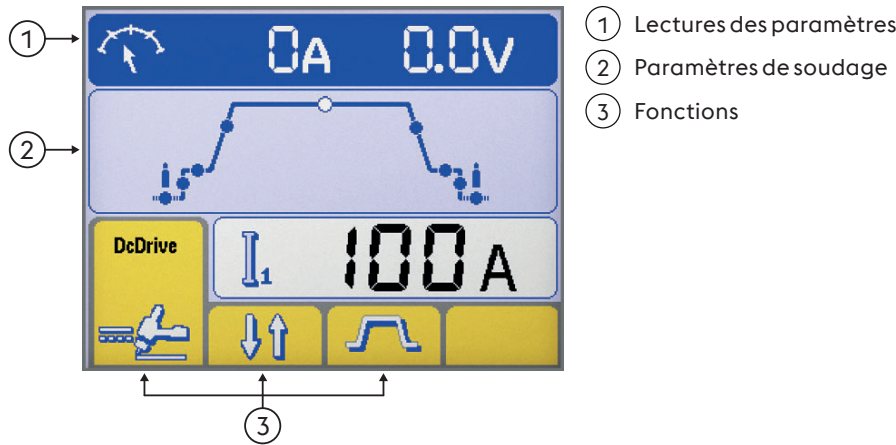

Lectures des paramètres

Durant l'opération de soudage, les valeurs de tension et courant réels sont affichées sur l'afficheur LCD.

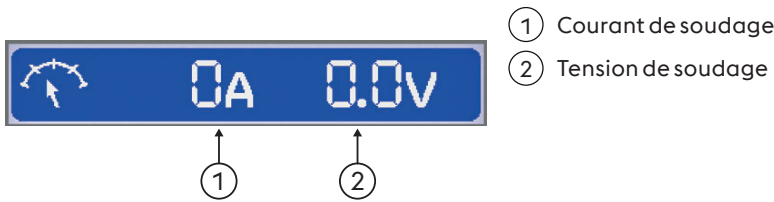

Paramètres de soudage

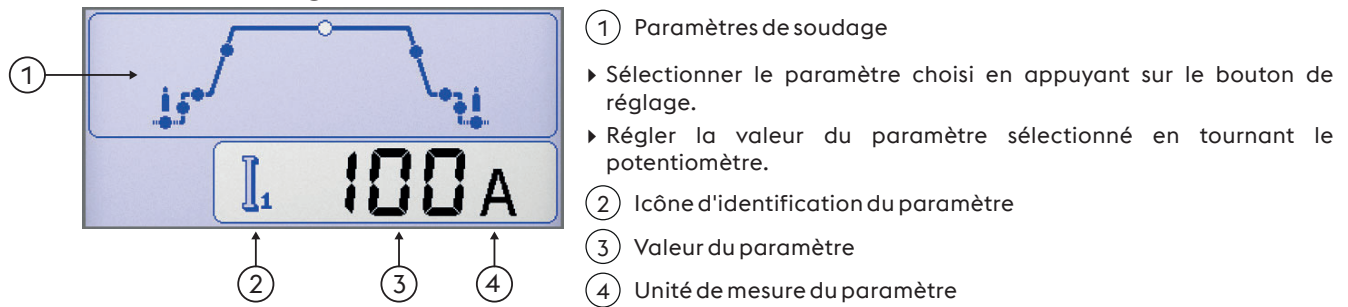

Fonctions

Permet la sélection des plus importantes fonctions de procédé et de mode de soudage.

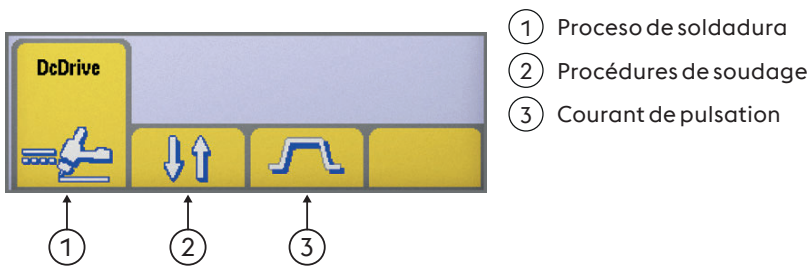

Proceso de soldadura



Procédures de soudage

Permet la sélection du mode de soudage

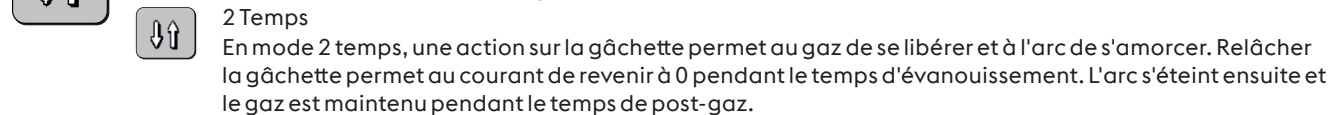

FR



4 Temps

En mode 4 temps une première pression sur la gâchette libère le gaz pendant le temps de pré-gaz manuel.



Bilevel

En bilevel, le soudeur peut souder avec deux courants différents réglés au préalable. La première pression sur la gâchette démarre le temps de pré gaz, l'amorçage de l'arc et le soudage du courant initial. Relâcher la gâchette démarre le temps de montée "I1". Si le soudeur appuie et relâche rapidement la gâchette, le programme change en mode "I2". S'il appuie et relâche la gâchette une nouvelle fois, le programme repasse en mode "I1" et ainsi de suite. Si on appuie plus longtemps, la rampe de diminution du courant démarre et on atteint le courant évanouissement. Relâcher la gâchette permet à l'arc de s'éteindre alors que le gaz est maintenu pendant le temps de post-gaz.



Courant de pulsation



Courant constant



Courant pulse



Fast Pulse



EasyArc

4.5 Ecran de programmes



Permet l'enregistrement et la gestion de 240 job qui peuvent être personnalisés par l'opérateur.

FR

Programmes (JOB)

Consulter la section "Ecran principal"

Programmation

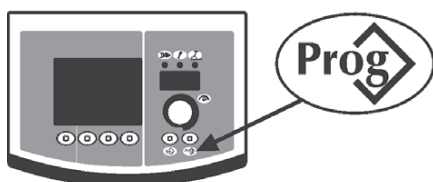

- ▶ Entrer dans le menu « program storage » (enregistrement programme) par une pression sur la touche. pendant au moins une seconde.



- ▶ Sélectionner le programme choisi (ou la mémoire vide) en tournant le potentiomètre.

--- Mémoire vide

Programme enregistré

- ▶ Annuler l'opération par une pression sur la touche .
- ▶ Enregistrer tous les réglages sur le programme sélectionné par une pression sur la touche. .

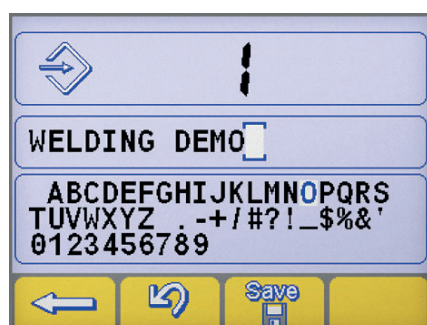

Inscrire la description du programme.

- ▶ Sélectionner la lettre souhaitée en tournant le potentiomètre.
- ▶ Enregistrer la lettre sélectionnée par une pression sur le bouton de réglage.
- ▶ Supprimer la dernière lettre par une pression sur la touche. .
- ▶ Annuler l'opération par une pression sur la touche .
- ▶ Confirmer l'opération par une pression sur la touche .



L'enregistrement d'un nouveau programme sur une position de mémoire déjà occupée nécessite la suppression de la position de la mémoire par une procédure obligatoire.



- ▶ Annuler l'opération par une pression sur la touche
- ▶ Déprogrammer le programme sélectionné par une pression sur la touche
- ▶ Reprendre la procédure d'enregistrement.

Rappel de programme

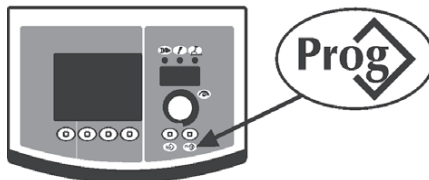

- ▶ Récupérer le 1er programme disponible par une pression sur la touche
 - ▶ Sélectionner le programme souhaité en tournant le potentiomètre.
 - ▶ Sélectionner le programme désiré par une pression sur la touche
- Seules les positions de mémoires occupées par un programme sont retrouvées, les programmes vides seront automatiquement sautés.

Annulation d'un programme



- ▶ Sélectionner le programme souhaité en tournant le potentiomètre.
- ▶ Déprogrammer le programme sélectionné par une pression sur la touche
- ▶ Annuler l'opération par une pression sur la touche



- ▶ Annuler l'opération par une pression sur la touche
- ▶ Déprogrammer le programme sélectionné par une pression sur la touche

5. MENU SET UP

5.1 Set up et paramétrage des paramètres

Il permet de saisir et de régler toute une série de paramètres supplémentaires pour une gestion plus précise du système de soudage.

Les paramètres présents dans le menu set up sont organisés en fonction du processus de soudage sélectionné et possèdent un code numérique.

Entrée dans le menu set up





- ▶ Il suffit d'appuyer pendant 5 secondes sur la touche encodeur.
- ▶ L'entrée sera confirmée par la mention 0 sur l'écran.

Sélection et réglage du paramètre désiré

- ▶ Tourner le potentiomètre pour afficher le code numérique relatif au paramètre désiré.
- ▶ Le fait d'appuyer sur le potentiomètre permet alors d'afficher la valeur saisie pour le paramètre sélectionné et le réglage correspondant.

Sortie du menu set up

- ▶ Appuyer de nouveau sur le potentiomètre pour quitter la section "réglage".
- ▶ Se placer sur le paramètre "0" (memoriser et quitter) et appuyer sur potentiomètre pour quitter le menu set up.
- ▶ Annuler l'opération par une pression sur la touche .
- ▶ Pour enregistrer la modification et quitter la configuration, appuyez sur la touche: .

5.1.1 Liste des paramètres du menu set up (MMA)

0 Mémoriser et quitter



Cette touche permet de mémoriser les modifications et de quitter le menu set up.

1 Réinitialisation (reset)



Cette touche permet de ramener tous les paramètres à la valeur par défaut.

3 Surintensité à l'amorçage



Il permet de régler la valeur de hot start en MMA.

Permet d'avoir un démarrage plus ou moins "chaud" durant les phases d'amorçage de l'arc, ce qui facilite en fait les opérations de démarrage.

Électrode basique

Minimum	Maximum	Réglage par défaut	par
0/off	500%	80%	

Électrode cellulosique

Minimum	Maximum	Réglage par défaut	par
0/off	500%	150%	

Électrode CrNi

Minimum	Maximum	Réglage par défaut	par
0/off	500%	100%	

Électrode aluminium

Minimum	Maximum	Réglage par défaut	par
0/off	500%	120%	

Électrode de fonte

Minimum	Maximum	Réglage par défaut	par
0/off	500%	100%	

Électrode rutilé

Minimum	Maximum	Réglage par défaut	par
0/off	500%	80%	

7 Courant de soudage

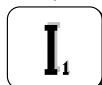

Il permet de régler le courant de soudage.

Minimum	Maximum	Réglage par défaut	par
3 A	Imax	100 A	

8 Arc force



Il permet de régler la valeur de l'Arc force en MMA.

Permet d'avoir une réponse dynamique plus ou moins énergétique durant le soudage, ce qui facilite en fait le travail du soudeur.

Augmenter la valeur de l'arc force pour réduire les risques de collage de l'électrode.

Électrode basique

Minimum	Maximum	Réglage par défaut	par
0/off	500%	30%	

Électrode cellulosique

Minimum	Maximum	Réglage par défaut	par
0/off	500%	350%	

Électrode CrNi

Minimum	Maximum	Réglage par défaut	par
0/off	500%	30%	

Électrode aluminium

Minimum	Maximum	Réglage par défaut	par
0/off	500%	100%	

Électrode de fonte

Minimum	Maximum	Réglage défaut	par
0/off	500%	70%	

Électrode rutile

Minimum	Maximum	Réglage défaut	par
0/off	500%	80%	

204 Dynamic power control (DPC)



Permet aux caractéristiques V/I choisies d'être sélectionnées.

I=C Courant constant

L'augmentation ou la diminution de la hauteur d'arc n'a aucun effet sur le courant de soudage exigé.

Recommandé pour l'électrode: Basique, Rutile, Acide, Acier, Fonte

1÷20 Diminution du gradient de contrôle

L'augmentation de la hauteur d'arc entraîne une baisse du courant de soudage (et vice versa) selon une valeur imposée de 1 à 20 Amps par volt.

Recommandé pour l'électrode: Cellulosique, Aluminium

P=C Puissance constante

L'augmentation de la hauteur d'arc entraîne une baisse du courant de soudage (et vice versa) selon la règle: $V \cdot I = K$

Recommandé pour l'électrode: Cellulosique, Aluminium

312 Tension de coupure de l'arc



Pour saisir la valeur de tension à laquelle l'arc électrique est obligé de s'éteindre.

Cette fonction permet de gérer les différentes conditions de fonctionnement qui se présentent.

Durant la phase de soudure point par point par exemple, une basse tension de coupure de l'arc réduit le réamorçage de l'arc lorsque l'on éloigne l'électrode de la pièce, réduisant ainsi les projections, les brûlures et l'oxydation de cette dernière.



Ne jamais saisir une tension de coupure d'arc supérieure à la tension à vide du générateur.

Électrode basique

Minimum	Maximum	Réglage défaut	par
0/off	Vmax	57.0 V	

Électrode cellulosique

Minimum	Maximum	Réglage défaut	par
0/off	Vmax	70.0 V	

399 Vitesse de découpage



Permet de régler la vitesse de soudage.

Default cm/min: vitesse de référence en soudage manuel.

Syn: valeur sinergique.

Minimum	Maximum	Réglage défaut	par
2 cm/min	200 cm/min	15 cm/min	

500 Configuration de la machine



Permet la sélection de l'interface graphique exigée.

Permet l'accès aux niveaux les plus hauts du set-up (sélection).

Consulter le paragraphe "Personnalisation d'interface (Set up 500)"

Valor	Niveau sélectionné
USER	Utilisateur
SERV	Service
vaBW	vaBW

Valor	Interface Utilisateur
XE	Mode Simple
XA	Mode Avancé
XP	Mode Expert

551 Lock/unlock



Permet le blocage d'accès au panneau de commandes et la possibilité d'insérer un code de protection.

Consulter le paragraphe "Lock/unlock (Set up 551)".

552 Tonalité du vibreur sonore



Pour régler la tonalité du vibreur sonore.

Minimum	Maximum	Réglage défaut	par
0/off	10	10	

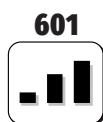
601 Réglage graduel

Permet le réglage graduel d'un paramètre qui peut être personnalisé par l'opérateur.

Minimum	Maximum	Réglage par défaut
1	I _{max}	1

602 Paramètre externe 2

Permet la gestion du paramètre externe 2 (valeur minimum, valeur maximum, valeur par défaut, paramètre sélectionné).

705 Calibration de résistance du circuit

Permet l'étalonnage du système.

Consulter le paragraphe "Calibration de résistance du circuit (set up 705)".

751 Lecture du courant

Permet l'affichage de la valeur réelle du courant de soudage.

752 Lecture de la tension

Permet l'affichage de la valeur réelle de la tension de soudage.

768 Mesure de l'apport de chaleur HI

Permet de lire la valeur de la mesure de l'apport thermique en soudage.

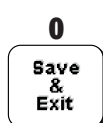
5.1.2 Liste des paramètres de configuration (TIG)

0 Mémoriser et quitter

Cette touche permet de mémoriser les modifications et de quitter le menu set up.

1 Réinitialisation (reset)

Cette touche permet de ramener tous les paramètres à la valeur par défaut.

2 Pré-gaz

Cette touche permet de sélectionner et de régler l'arrivée du gaz avant l'amorçage de l'arc.

Elle permet d'alimenter le gaz dans la torche et de préparer la soudure.

Minimum	Maximum	Réglage par défaut
0/off	99.9 s	0.1 s

3 Courant initial

Permet le réglage du courant de départ de la soudure.

Permet d'obtenir un bain de soudage plus chaud ou plus froid immédiatement après l'amorçage de l'arc.

Minimum	Maximum	Réglage par défaut	Minimum	Maximum	Réglage par défaut
1%	200%	50%	3 A	I _{max}	-

5 Temps de courant initial

Permet le réglage du temps durant lequel le courant initial est maintenu.

Minimum	Maximum	Réglage par défaut
0/off	99.9 s	0/off

FR

6 Rampe de montée



Elle permet de passer graduellement du courant initial au courant de soudage.

Minimum	Maximum	Réglage défaut	par
0/off	99.9 s	0/off	

7 Courant de soudage

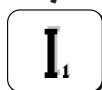

Il permet de régler le courant de soudage.

Minimum	Maximum	Réglage défaut	par
3 A	Imax	100 A	

8 Courant de bilevel

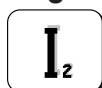

Il permet de régler le courant secondaire dans le mode de soudage bilevel.

Quand on appuie une première fois sur le bouton-poussoir de la torche, on obtient la sortie du gaz avant l'amorçage de l'arc, l'amorçage de l'arc et le soudage en courant de départ.

Au premier relâchement, on passe au niveau du courant "I1".

En appuyant sur la gachette et puis en la relâchant rapidement, on passe au niveau "I2".

Chaque fois qu'on répète cette opération on change le niveau du courant de "I1" à "I2" et vice versa.

Si on appuie plus longtemps, la rampe de diminution du courant démarre et on atteint le courant évanouissement.

Réglages des paramètres: Ampères (A) - Pourcentages (%).

Minimum	Maximum	Réglage défaut	par
3 A	Imax	-	

Minimum	Maximum	Réglage défaut	par
1%	500%	off	

10 Courant de base



Il permet de régler le courant de base en mode pulsé et double pulsation.

Minimum	Maximum	Réglage défaut	par
3 A	Isald	-	

Minimum	Maximum	Réglage défaut	par
1%	100%	50%	

12 Fréquence de pulsation



Permet le réglage de la fréquence de pulsation.

Permet d'obtenir de meilleurs résultats de soudage sur de fines épaisseurs et un meilleur aspect du cordon de soudure.

Minimum	Maximum	Réglage défaut	par
0.1 Hz	25 Hz	5 Hz	

13 Facteur de marche de pulsation



Permet le réglage du facteur de marche en soudage pulsé.

Permet de maintenir le courant de crête pendant un temps plus ou moins long.

Minimum	Maximum	Réglage défaut	par
1 %	99 %	50 %	

14 Fréquence de pulsation rapide

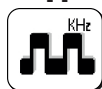

Permet le réglage de la fréquence de pulsation.

Permet de focaliser l'action et d'obtenir une meilleure stabilité de l'arc électrique.

Minimum	Maximum	Réglage défaut	par
0.02 KHz	2.5 KHz	0.25 KHz	

15 Rampes de pulsation



Permet le réglage du temps de pente durant le mode de pulsation.

Permet le passage progressif entre le courant de crête et le courant de base afin d'obtenir un arc de soudage plus ou moins doux.

Minimum	Maximum	Réglage défaut	par
0/off	100 %	0/off	

16 Evanouissement

Elle permet de passer graduellement du courant de soudage au courant final.

Minimum	Maximum	Réglage par défaut	par
0/off	99.9 s	0/off	

17 Courant final

Il permet de régler le courant final.

Minimum	Maximum	Réglage par défaut	par	Minimum	Maximum	Réglage par défaut	par
3 A	Imax	10 A		1 %	200 %	50 %	

19 Temps de courant final

Permet de régler le temps durant lequel le courant final est maintenu.

Minimum	Maximum	Réglage par défaut	par
0/off	99.9 s	0/off	

20 Post gaz



Il permet de régler l'arrivée du gaz en fin de soudage.

Minimum	Maximum	Réglage par défaut	par
0/off	99.9 s	syn	

203 Tig start (HF)

Permet la sélection des modes d'amorçage de l'arc:

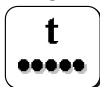
Valor	Réglage par défaut	par	Fonction de rappel
on	X		HF START
off	-		LIFT START

204 Soudage par point

Permet l'accès au mode « soudage par point » et le réglage de la durée du point.

Permet le minutage du procédé de soudage.

Minimum	Maximum	Réglage par défaut	par
0/off	99.9 s	0/off	

205 Redémarrage

Permet l'activation de la fonction redémarrage.

Permet l'arrêt immédiat de l'arc durant la période d'évanouissement ou le redémarrage du cycle de soudage.

Valor	Réglage par défaut	par	Fonction de rappel
0/off	-		off
1/on	X		on
2/of1	-		off

206 Easy joining

Permet l'amorçage de l'arc en courant pulsé et le minutage de la fonction avant la réinstallation automatique des conditions de soudage pré-enregistrées.

Permet une grande vitesse et une précision durant les opérations de soudage de pointe sur les pièces.

Minimum	Maximum	Réglage par défaut	par
0.1 s	25.0 s	0/off	

FR

208 Microtime spot welding



Cette touche permet d'activer le mode "microtime spot welding".
Permet le minutage du procédé de soudage.

Minimum	Maximum	Réglage par défaut
0.01 s	1.00 s	0/off

399 Vitesse de découpage



Permet de régler la vitesse de soudage.
Default cm/min: vitesse de référence en soudage manuel.
Syn: valeur synergique.

Minimum	Maximum	Réglage par défaut
2 cm/min	200 cm/min	10 cm/min

500 Configuration de la machine



Permet la sélection de l'interface graphique exigée.
Permet l'accès aux niveaux les plus hauts du set-up (sélection).
Consulter le paragraphe "Personnalisation d'interface (Set up 500)"

Valor	Niveau sélectionné
USER	Utilisateur
SERV	Service
vaBW	vaBW

Valor	Interface Utilisateur
XE	Mode Simple
XA	Mode Avancé
XP	Mode Expert

551 Lock/unlock



Permet le blocage d'accès au panneau de commandes et la possibilité d'insérer un code de protection.
Consulter le paragraphe "Lock/unlock (Set up 551)".

552 Tonalité du vibreur sonore



Pour régler la tonalité du vibreur sonore.

Minimum	Maximum	Réglage par défaut
0/off	10	10

601 Réglage graduel



Permet le réglage graduel d'un paramètre qui peut être personnalisé par l'opérateur.

Minimum	Maximum	Réglage par défaut
1	Imax	1

602 Paramètre externe CH1, CH2, CH3, CH4



Permet la gestion du paramètre externe 1, 2, 3, 4 (valeur minimum, valeur maximum, valeur par défaut, paramètre sélectionné).

Consulter le paragraphe "Gestion des commandes externes (Set up 602)".

606 Torche U/D



Permet la gestion du paramètre externe (U/D).

Valor	Réglage par défaut	par	Fonction de rappel
0/off	-		off
1/11	X		Courant
	-		Rappel de programme

612 Réglage de la torche DgTig
**DiGi
TIG**

Permet la gestion des canaux de la torche numérique.

Valor	Réglage par défaut	Fonction de rappel
0/off	-	off
1/I1	-	Courant
2/ 	-	Rappel de programme
3/CH3	-	CH3
4/CH4	-	CH4
5/STD	X	STD

705 Calibration de résistance du circuit

Permet l'étalonnage du système.

Consulter le paragraphe "Calibration de résistance du circuit (set up 705)".

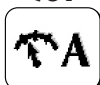
751 Lecture du courant

Permet l'affichage de la valeur réelle du courant de soudage.

752 Lecture de la tension

Permet l'affichage de la valeur réelle de la tension de soudage.

758 Vitesse du mouvement robot

Permet l'affichage de la vitesse du mouvement du bras d'un robot ou d'un dispositif d'automatisation.

764 Lecture du débit du liquide réfrigérant

Permet l'affichage de la valeur du liquide réfrigérant.

765 Lecture du température du liquide réfrigérant

Permet l'affichage de la valeur réelle du température du liquide réfrigérant.

768 Mesure de l'apport de chaleur HI

Permet de lire la valeur de la mesure de l'apport thermique en soudage.

801 Limites de sécurité

Permet la sélection des limites d'avertissement et de sécurité.

Permet de contrôler le procédé de soudage en mettant des limites de sécurité et d'avertissement sur les principaux paramètres de soudage mesurables.

Permet le contrôle précis des différentes phases de soudage.

FR

5.2 Procédures spécifiques d'utilisation des paramètres

5.2.1 Personnalisation de l'écran à 7 segments

Permet d'afficher en permanence la valeur d'un paramètre sur l'écran à 7 segments.

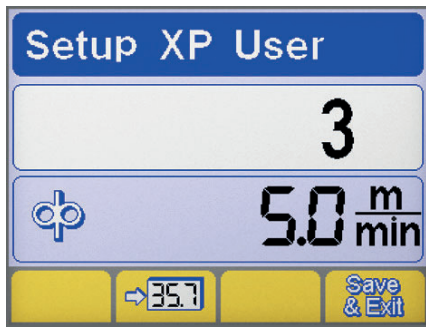

- ▶ Entrer dans le menu de sélection (Set-up) par une pression d'au moins 5 secondes sur le bouton de réglage.
- ▶ Sélectionner le paramètre souhaité en tournant le potentiomètre.
- ▶ Enregistrer le paramètre sélectionné dans l'écran à 7 segments par une pression sur la touche **35.7**.
- ▶ Sauvegarder et sortir de l'écran en cours par une pression sur la touche **Save**.

5.2.2 Personnalisation d'interface (Set up 500)

Permet la personnalisation des paramètres sur le menu principal.

500 Configuration de la machine



Permet la sélection de l'interface graphique exigée.

Valor	Interface Utilisateur
XE	Mode Simple
XA	Mode Avancé
XP	Mode Expert

MODEXE

MMA

Paramètres de soudage

TIG

Paramètres de soudage

Fonctions

MODEXA

MMA

Paramètres de soudage

Fonctions

TIG

Paramètres de soudage

Fonctions

MODE XP

MMA	
Paramètres de soudage	
Fonctions	
TIG	
Paramètres de soudage	
Fonctions	

5.2.3 Lock/unlock (Set up 551)

Permet le blocage d'accès au panneau de commandes et la possibilité d'insérer un code de protection.

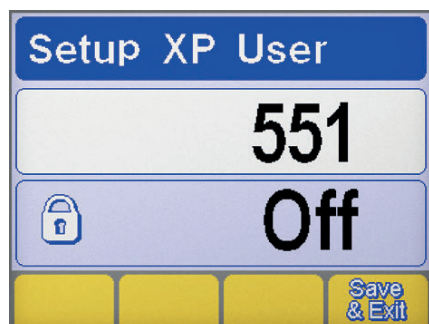
Sélection du paramètre

- ▶ Entrer dans le menu de sélection (Set-up) par une pression d'au moins 5 secondes sur le bouton de réglage.
- ▶ Sélectionner le paramètre désiré (551).
- ▶ Activer le réglage du paramètre sélectionné par une pression sur le bouton de réglage.

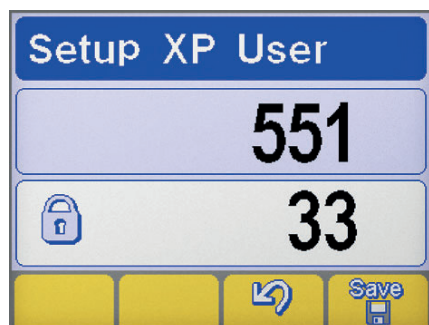
Réglage du mot de passe

- ▶ Sélectionner un code numérique (mot de passe) en tournant le potentiomètre.
- ▶ Confirmez l'opération en appuyant sur la touche de l'encodeur.
- ▶ Annuler l'opération par une pression sur la touche .
- ▶ Pour enregistrer la modification, appuyez sur la touche: .

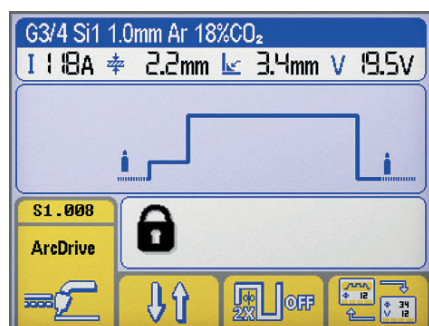
Fonctions du panneau



La poursuite de toute opération sur un panneau de contrôle bloqué fait apparaître un écran spécial.

- ▶ Accéder temporairement (5 minutes) aux fonctionnalités du panneau en tournant le potentiomètre et en entrant le mot de passe correct.
- ▶ Confirmez l'opération en appuyant sur la touche de l'encodeur.
- ▶ Déverrouiller définitivement le panneau de commande en entrant dans le menu de sélection (Set-up) (suivre les instructions décrites ci-dessus) et ramener le paramètre 551 en position « off ».
- ▶ Confirmez l'opération en appuyant sur la touche de l'encodeur.
- ▶ Pour enregistrer la modification, appuyez sur la touche: .

FR

5.2.4 Gestion des commandes externes (Set up 602)

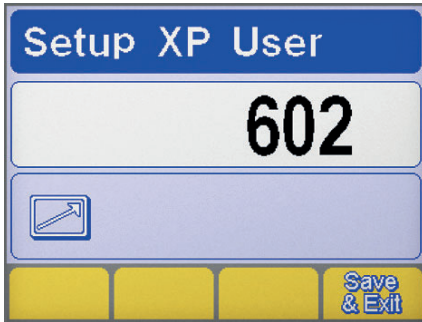
Permet la gestion du paramètre externe 2 (valeur minimum, valeur maximum, valeur par défaut, paramètre sélectionné).



Sélection du paramètre

- ▶ Entrer dans le menu de sélection (Set-up) par une pression d'au moins 5 secondes sur le bouton de réglage.
- ▶ Sélectionner le paramètre désiré (602).
- ▶ Entrer dans l'écran de « Gestion des commandes externes » par une pression sur le bouton de réglage.

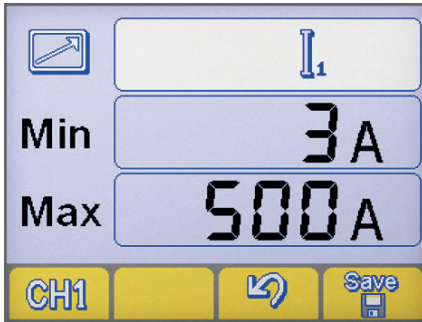

Gestion des commandes externes

- ▶ Sélectionner la sortie de commande à distance RC désirée (CH1, CH2, CH3, CH4) par une pression sur la touche **CH1**.
- ▶ Sélectionner le paramètre souhaité (Min-Max-parametre) par une pression sur le bouton de réglage.
- ▶ Régler le paramètre souhaité (Min-Max-parametre) en tournant le potentiomètre.
- ▶ Pour enregistrer la modification, appuyez sur la touche: **Save**.
- ▶ Annuler l'opération par une pression sur la touche **ESC**.

FR

5.2.5 Calibration de résistance du circuit (set up 705)

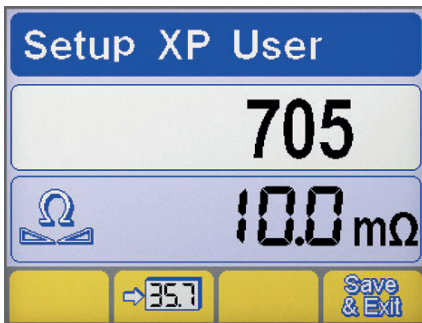

Sélection du paramètre

- ▶ Entrer dans le menu de sélection (Set-up) par une pression d'au moins 5 secondes sur le bouton de réglage.
- ▶ Sélectionner le paramètre désiré (705).
- ▶ Activer le réglage du paramètre sélectionné par une pression sur le bouton de réglage.

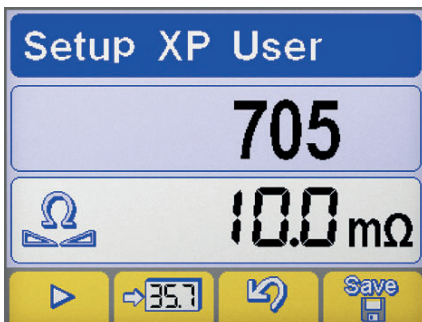

Étalonnage

- ▶ Placer l'électrode en tungstène en contact électrique avec la pièce à souder. (TIG)
- ▶ Mettre en contact la torche porte-électrode et la pièce à souder. (MMA)
- ▶ Appuyez sur la touche **▶** (ou le bouton de la torche) pour lancer la procédure.
- ▶ Maintenez le contact pendant au moins une seconde.
- ▶ La valeur affichée sur l'écran sera mise à jour après l'étalonnage.
- ▶ Confirmer l'opération par une pression sur la touche **Save**.
- ▶ Annuler l'opération par une pression sur la touche **ESC**.
- ▶ Pour enregistrer la modification et quitter la configuration, appuyez sur la touche: **Save & Exit**.

5.2.6 Limites de sécurité (Set up 801)

Permet la sélection des limites d'avertissement et de sécurité.

Permet de contrôler le procédé de soudage en mettant des limites de sécurité et d'avertissement sur les principaux paramètres de soudage mesurables.

Permet le contrôle précis des différentes phases de soudage.

Consulter le paragraphe "Limites de sécurité (Set up 801)".



I Courant de soudage

V Tension de soudage

⚡ Lecture du débit gaz

⚙️ Vitesse du mouvement robot



Lecture du courant (moteur 1)



Lecture du courant (moteur 2)



Lecture du débit du liquide réfrigérant



Lecture vitesse fil

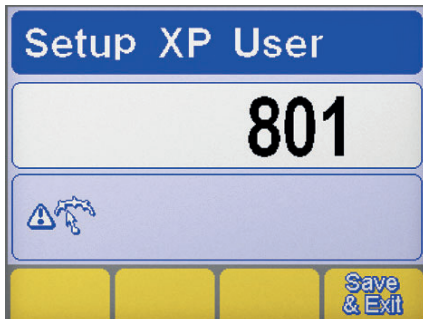

Lecture du température du liquide réfrigérant

Sélection du paramètre

- ▶ Entrer dans le menu de sélection (Set-up) par une pression d'au moins 5 secondes sur le bouton de réglage.
- ▶ Sélectionner le paramètre désiré (801).
- ▶ Entrer sur l'écran « Limites de sécurité » par une pression sur le bouton de réglage.

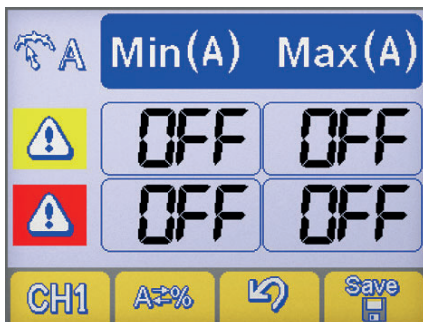
Sélection du paramètre

- ▶ Sélectionner le paramètre souhaité par une pression sur la touche **CH1**.
- ▶ Sélectionner le mode de sélection des limites de sécurité par une pression sur la touche **A=%**.

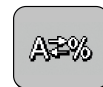
Configuration de la machine

Valeur absolue

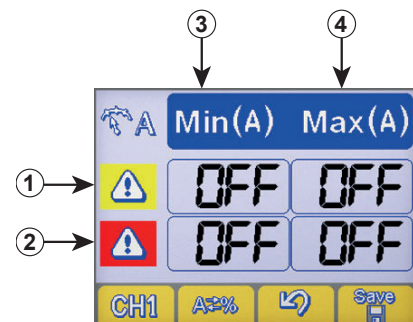

Valeur en pourcentage

Configuration des seuils de protection

- ① Ligne de limite d'avertissement
- ② Ligne de limites d'alarmes
- ③ Colonne de niveaux minimums
- ④ Colonne de niveaux maximums

- ▶ Sélectionner la case souhaitée par une pression sur le bouton de réglage (la case sélectionnée apparaît en surbrillance).
- ▶ Régler le niveau de la limite sélectionnée en tournant le potentiomètre.
- ▶ Pour enregistrer la modification, appuyez sur la touche: **Save**.



Dépasser une des limites d'avertissement déclenche un signal visuel sur le panneau de commandes.



Dépasser une des limites d'alarme déclenche un signal visuel sur le panneau de commandes et le blocage immédiat des opérations de soudage.



Il est possible de mettre des filtres de début et de fin de soudure afin d'éviter des messages d'erreur durant l'amorçage et l'extinction de l'arc (consulter le paragraphe « Set up » - Paramètres 802-803-804).

6. ENTRETIEN



Effectuer l'entretien courant de l'installation selon les indications du constructeur. Toutes les portes d'accès et de service et les couvercles doivent être fermés et bien fixés lorsque l'appareil est en marche. L'installation ne doit absolument pas être modifiée. Eviter l'accumulation de poussière métallique à proximité et sur les grilles d'aération.



Toute opération éventuelle de maintenance doit exclusivement être effectuée par du personnel qualifié. La réparation ou le remplacement de pièces de la part de personnel non autorisé implique l'annulation immédiate de la garantie du produit. La réparation ou le remplacement de pièces doit exclusivement être effectué par du personnel technique qualifié.



Couper l'alimentation électrique de l'installation avant toute intervention!

6.1 Contrôles périodiques sur le générateur

6.1.1 Système



Effectuer le nettoyage interne avec de l'air comprimé à basse pression et des brosses souples. Contrôler les connexions électriques et tous les câbles de branchement.

6.1.2 Pour la maintenance ou le remplacement des composants des torches, de la pince porte-électrode et/ou des câbles de masse:



Contrôler la température des composants et s'assurer qu'ils ne sont pas trop chauds.



Toujours porter des gants conformes aux normes.



Utiliser des clefs et des outils adéquats.

6.2 Responsabilité



Le constructeur décline toute responsabilité si l'opérateur ne respecte pas ces instructions. Le constructeur décline toute responsabilité si l'opérateur ne respecte pas ces instructions. En cas de doute et/ou de problème, n'hésitez pas à consulter le dépanneur agréé le plus proche.

7. CODES D'ALARMES



ALARME

L'intervention d'une alarme ou le dépassement d'un seuil critique de protection entraîne une signalisation visuelle sur le panneau de commande et le blocage immédiat des opérations de soudage.



ATTENTION

Le dépassement d'un seuil de protection entraîne une signalisation visuelle sur le panneau de commande, mais permet de poursuivre les opérations de soudage.

Ci-dessous figure la liste de toutes les alarmes et de tous les seuils critiques de protection du système.

E01	Surtempérature		E02	Surtempérature	
E03	Surtempérature		E05	Surintensité	
E06	Surintensité du module de puissance (Boost)		E07	Défaut du système d'alimentation du moteur du dévidoir	

 E08	Moteur bloqué		 E10	Surintensité du module de puissance (Inverter)	
 E11	Erreur de configuration du système		 E13	Erreur de communication (FP)	
 E14.xx	Programme non valide le sous-code de l'erreur indique le numéro du job supprimé		 E15	Programme non valide	
 E16	Erreur de communication (RI) (Automatisation et robotique)		 E18.xx	Programme non valide le sous-code de l'erreur indique le numéro du job supprimé	
 E19	Erreur de configuration du système		 E20	Mémoire défectueuse	
 E21	Perte de données		 E22	Erreur de communication (DSP)	
 E27	Mémoire défectueuse (RTC)		 E29	Mesures incompatibles	
 E30	Erreur de communication (H.F.)		 E32	Perte de données	
 E33	Erreur de configuration du système (LCD 3.5")		 E38	Sous-tension	
 E39	Défaut d'alimentation du système		 E40	Défaut d'alimentation du système	
 E41	Surtension		 E42	Sous-tension	
 E43	Liquide de refroidissement manquant		 E49	Interrupteur d'urgence (Automatisation et robotique)	
 E51	Paramètres non pris en charge (Automatisation et robotique)		 E52	Anti-collision (Automatisation et robotique)	
 E53	Erreur de fluxostat externe (Automatisation et robotique)		 E54	Niveau de courant dépassé (Limite inférieure)	
 E55	Niveau de courant dépassé (Limite supérieure)		 E56	Niveau de tension dépassé (Limite inférieure)	
 E57	Niveau de tension dépassé (Limite supérieure)		 E58	Niveau de flux de gaz dépassé (Limite inférieure)	
 E59	Niveau de flux de gaz dépassé (Limite supérieure)		 E62	Niveau de courant dépassé (Limite inférieure)	

E63	Niveau de courant dépassé (Limite supérieure)		E64	Niveau de tension dépassé (Limite inférieure)	
E65	Niveau de tension dépassé (Limite supérieure)		E66	Niveau de flux de gaz dépassé (Limite inférieure)	
E67	Niveau de flux de gaz dépassé (Limite supérieure)		E71	Surchauffe liquide de refroidissement	
E72	Surintensité du moteur push-pull		E73	Limite de vitesse du fil dépassée (speed meter)	
E75	Niveau de courant moteur 2 dépassé		E76	Niveau de débit du liquide de refroidissement dépassé	
E77	Niveau de température du liquide de refroidissement		E78	Maintenance active (Automatisation et robotique)	
E81	Surintensité (pompe WU)		E82	Erreur de communication (WU)	
E83	Pompe bloquée		E99	Alarme générale	

8. DIAGNOSTIC ET SOLUTIONS

L'installation ne s'allume pas (le voyant vert est éteint)

Cause

- » Pas de tension de réseau au niveau de la prise d'alimentation.
- » Connecteur ou câble d'alimentation défectueux.
- » Fusible grillé.
- » Interrupteur marche/arrêt défectueux.
- » Installation électronique défectueuse.

Solution

- » Effectuer une vérification et procéder à la réparation de l'installation électrique.
- » S'adresser à un personnel spécialisé.
- » Remplacer le composant endommagé.
- » S'adresser service après-vente le plus proche pour la réparation de l'installation.
- » Remplacer le composant endommagé.
- » Remplacer le composant endommagé.
- » S'adresser service après-vente le plus proche pour la réparation de l'installation.
- » S'adresser service après-vente le plus proche pour la réparation de l'installation.

Absence de puissance à la sortie (l'installation ne soude pas)

Cause

- » Gâchette de torche défectueux.
- » Installation a surchauffé (défaut thermique - voyant jaune allumé).
- » Connexion à la masse incorrecte.
- » Tension de réseau hors plage (voyant jaune allumé).

Solution

- » Remplacer le composant endommagé.
- » S'adresser service après-vente le plus proche pour la réparation de l'installation.
- » Attendre que le système refroidisse sans éteindre l'installation.
- » Procéder à la connexion correcte à la masse.
- » Consulter le paragraphe "Mise en service".
- » Ramener la tension de réseau dans la plage d'alimentation du générateur
- » Effectuer le raccordement correct de l'installation.
- » Consulter le paragraphe "Raccordement".

» Contacteur défectueux.

» Remplacer le composant endommagé.

» S'adresser service après-vente le plus proche pour la réparation de l'installation.

» Installation électronique défectueuse.

» S'adresser service après-vente le plus proche pour la réparation de l'installation.

Courant de sortie incorrect

Cause

- » Sélection erronée du mode de soudage ou sélecteur défectueux.
- » Réglages erronés des paramètres et des fonctions de l'installation.
- » Potentiomètre d'interface du réglage du courant de soudage défectueux.
- » Tension de réseau hors plage.
- » Phase manquante.
- » Installation électronique défectueuse.

Solution

- » Procéder à la sélection correcte du mode de soudage.
- » Réinitialiser l'installation et régler de nouveau les paramètres de soudage.
- » Remplacer le composant endommagé.
- » S'adresser service après-vente le plus proche pour la réparation de l'installation.
- » Effectuer le raccordement correct de l'installation.
- » Consulter le paragraphe "Raccordement".
- » Effectuer le raccordement correct de l'installation.
- » Consulter le paragraphe "Raccordement".
- » S'adresser service après-vente le plus proche pour la réparation de l'installation.

Instabilité de l'arc

Cause

- » Gaz de protection insuffisant.
- » Présence d'humidité dans le gaz de soudage.
- » Paramètres de soudage incorrects.

Solution

- » Régler le débit de gaz.
- » Vérifier le bon état de la buse et du diffuseur gaz de la torche.
- » Toujours utiliser des produits et des matériaux de qualité.
- » Veiller à maintenir l'installation d'alimentation du gaz en parfaites conditions.
- » Effectuer un contrôle de l'installation de soudage.
- » S'adresser service après-vente le plus proche pour la réparation de l'installation.

Projections excessives

Cause

- » Longueur de l'arc incorrecte.
- » Paramètres de soudage incorrects.
- » Gaz de protection insuffisant.
- » Dynamique d'arc incorrecte.
- » Mode de soudage incorrect.

Solution

- » Réduire la distance entre l'électrode et la pièce.
- » Réduire la tension de soudage.
- » Réduire la tension de soudage.
- » Régler le débit de gaz.
- » Vérifier le bon état de la buse et du diffuseur gaz de la torche.
- » Changer la masse de place sur une valeur supérieure.
- » Réduire l'inclinaison de la torche.

Pénétration insuffisante

Cause

- » Mode de soudage incorrect.
- » Paramètres de soudage incorrects.
- » Electrode inadaptée.
- » Préparation incorrecte des bords.
- » Connexion à la masse incorrecte.
- » Dimension des pièces à souder trop importante.

Solution

- » Réduire la vitesse de progression du soudage.
- » Augmenter l'intensité de soudage.
- » Utiliser une électrode de diamètre inférieur.
- » Augmenter le chanfrein.
- » Procéder à la connexion correcte à la masse.
- » Consulter le paragraphe "Mise en service".
- » Augmenter l'intensité de soudage.

Inclusions de scories

Cause

- » Encrassage.
- » Diamètre de l'électrode trop gros.
- » Préparation incorrecte des bords.
- » Mode de soudage incorrect.

Solution

- » Effectuer un nettoyage des pièces avant d'effectuer le soudage.
- » Utiliser une électrode de diamètre inférieur.
- » Augmenter le chanfrein.
- » Réduire la distance entre l'électrode et la pièce.
- » Avancer régulièrement pendant toutes les phases de soudage.

Inclusions de tungstène

Cause

- » Paramètres de soudage incorrects.
- » Electrode inadaptée.
- » Mode de soudage incorrect.

Solution

- » Réduire la tension de soudage.
- » Utiliser une électrode de diamètre supérieur.
- » Toujours utiliser des produits et des matériaux de qualité.
- » Affûter correctement l'électrode.
- » Eviter les contacts entre l'électrode et le bain de soudure.

Soufflures

Cause

- » Gaz de protection insuffisant.

Solution

- » Régler le débit de gaz.
- » Vérifier le bon état de la buse et du diffuseur gaz de la torche.

Collages

Cause

- » Longueur de l'arc incorrecte.
- » Paramètres de soudage incorrects.
- » Mode de soudage incorrect.
- » Dimension des pièces à souder trop importante.
- » Dynamique d'arc incorrecte.

Solution

- » Augmenter la distance entre l'électrode et la pièce.
- » Augmenter la tension de soudage.
- » Augmenter l'intensité de soudage.
- » Augmenter la tension de soudage.
- » Augmenter l'inclinaison de la torche.
- » Augmenter l'intensité de soudage.
- » Augmenter la tension de soudage.
- » Changer la masse de place sur une valeur supérieure.

Effondrement du métal

Cause

- » Paramètres de soudage incorrects.
- » Longueur de l'arc incorrecte.
- » Mode de soudage incorrect.
- » Gaz de protection insuffisant.

Solution

- » Réduire la tension de soudage.
- » Utiliser une électrode de diamètre inférieur.
- » Réduire la distance entre l'électrode et la pièce.
- » Réduire la tension de soudage.
- » Réduire la vitesse d'oscillation latérale de remplissage.
- » Réduire la vitesse de progression du soudage.
- » Utiliser des gaz adaptés aux matériaux à souder.

Oxydations

Cause

- » Gaz de protection insuffisant.

Solution

- » Régler le débit de gaz.
- » Vérifier le bon état de la buse et du diffuseur gaz de la torche.

Porosité

Cause

- » Présence de graisse, de peinture, de rouille ou de saleté sur les pièces à souder.

Solution

- » Effectuer un nettoyage des pièces avant d'effectuer le soudage.

» Présence de graisse, de peinture, de rouille ou de saleté sur métal d'apport.	» Toujours utiliser des produits et des matériaux de qualité. » Toujours conserver le d'apport en parfaites conditions.
» Présence d'humidité dans le métal d'apport.	» Toujours utiliser des produits et des matériaux de qualité. » Toujours conserver le d'apport en parfaites conditions.
» Longueur de l'arc incorrecte.	» Réduire la distance entre l'électrode et la pièce. » Réduire la tension de soudage.
» Présence d'humidité dans le gaz de soudage.	» Toujours utiliser des produits et des matériaux de qualité. » Veiller à maintenir l'installation d'alimentation du gaz en parfaites conditions.
» Gaz de protection insuffisant.	» Régler le débit de gaz. » Vérifier le bon état de la buse et du diffuseur gaz de la torche.
» Solidification du bain de soudure trop rapide.	» Réduire la vitesse de progression du soudage. » Préchauffer les pièces à souder. » Augmenter l'intensité de soudage.

Faissures chaudes

Cause

- » Paramètres de soudage incorrects.
- » Présence de graisse, de peinture, de rouille ou de saleté sur les pièces à souder.
- » Présence de graisse, de peinture, de rouille ou de saleté sur métal d'apport.
- » Mode de soudage incorrect.
- » Pièces à souder présentant des caractéristiques différentes.

Solution

- » Réduire la tension de soudage.
- » Utiliser une électrode de diamètre inférieur.
- » Effectuer un nettoyage des pièces avant d'effectuer le soudage.
- » Toujours utiliser des produits et des matériaux de qualité.
- » Toujours conserver le d'apport en parfaites conditions.
- » Suivre les étapes correctes pour le type de joint à souder.
- » Effectuer un beurrage avant de procéder au soudage.

Faissures froides

Cause

- » Présence d'humidité dans le métal d'apport.
- » Géométrie spéciale du joint à souder.

Solution

- » Toujours utiliser des produits et des matériaux de qualité.
- » Toujours conserver le d'apport en parfaites conditions.
- » Préchauffer les pièces à souder.
- » Effectuer un post-chauffage.
- » Suivre les étapes correctes pour le type de joint à souder.

9. MODE D'EMPLOI

9.1 Soudage à l'électrode enrobée (MMA)

Préparation des bords

Pour obtenir une bonne soudure, il est toujours conseillé de travailler sur des pièces propres, sans oxydation, ni rouille ou autre agent contaminant.

Choix de l'électrode

Le diamètre de l'électrode à utiliser dépend de l'épaisseur de la pièce, de la position, du type de joint et du type de préparation de la pièce à souder.

Les électrodes de gros diamètre ont besoin d'intensité et de températures plus élevées pendant le soudage.

Type d'enrobage	Propriétés	Utilisation
Rutile	Facilité d'emploi	Toutes positions
Acide	Vitesse de fusion élevée	Plat
Basique	Caract. mécaniques	Toutes positions

Choix du courant de soudage

La gamme du courant de soudage relative au type d'électrode utilisé est spécifiée sur le boîtier des électrodes.

FR

Amorçage et maintien de l'arc

On amorce l'arc électrique en frottant la pointe de l'électrode sur la pièce à souder connectée à un câble de masse, et une fois que l'arc a jailli, retirer la baguette rapidement jusqu'à la distance de soudage normale.

En général une surintensité de l'intensité par rapport l'intensité initiale du soudage (Hot-Start) est utile pour améliorer l'amorçage de l'arc.

Après l'amorçage de l'arc, la fusion de la partie centrale de l'électrode commence; celle-ci se dépose sur la pièce à souder sous forme de gouttes.

L'enrobage extérieur de l'électrode consommée fournit le gaz de protection pour la soudure, assurant ainsi une bonne qualité de soudure.

Pour éviter que les gouttes fondues éteignent l'arc en court-circuitant et collant l'électrode sur le cordon, par un rapprochement accidentel entre les deux éléments, une augmentation momentanée de l'intensité de soudage est produite jusqu'à la fin du court-circuit (Arc Force).

Réduire le courant de court-circuit au minimum (anti-collage) si l'électrode reste collée à la pièce à souder.

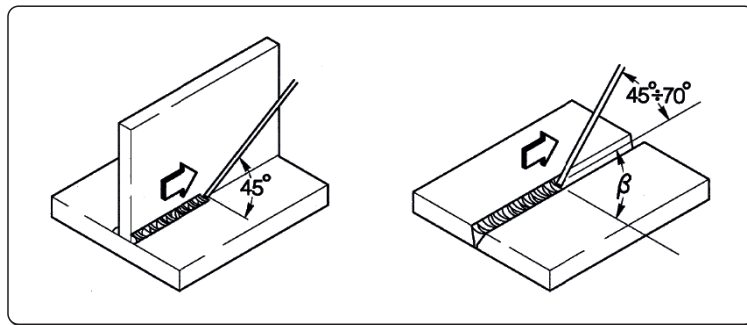

Exécution de la soudure

L'angle d'inclinaison de l'électrode varie en fonction du nombre de passes, le mouvement de l'électrode est normalement exécuté par oscillations et arrêts sur les bords du cordon de façon à éviter une accumulation excessive de dépôt au centre.

FR

Nettoyage des scories

Le soudage par électrodes enrobées implique obligatoirement le prélèvement des scories après chaque passe.

Le nettoyage se fait à l'aide d'un petit marteau ou d'une brosse métallique en cas de scories friables.

9.2 Soudage TIG (arc en soudure continue)

Description

Les principes du mode de soudage TIG (Tungsten Inert Gas) est basé sur un arc électrique qui jaillit entre une électrode infusible (tungstène pur ou alliage, température de fusion à environ 3370°C) et la pièce. Une atmosphère de gaz inerte (argon) protège le bain.

Afin d'éviter des inclusions de tungstène dangereuses dans la soudure, l'électrode ne doit jamais toucher la pièce à souder, et c'est pour cela qu'on génère une décharge à l'aide d'un générateur HF, ce qui permet d'amorcer l'arc électrique à distance.

Il existe un autre type d'amorçage, avec des inclusions de tungstène en faible quantité: l'amorçage au contact (lift arc) qui ne prévoit pas une haute fréquence mais seulement un court-circuit à faible intensité entre l'électrode et la pièce; en éloignant l'électrode l'arc s'amorcera et l'intensité augmentera jusqu'à atteindre la valeur de soudage programmée.

Pour améliorer la qualité de la fin du cordon de soudure, il est utile de pouvoir vérifier avec précision l'évanouissement de l'intensité. Le gaz doit continuer à sortir sur le bain de soudure pendant quelques secondes après l'extinction de l'arc.

Dans de nombreuses conditions opérationnelles, il est utile de disposer de 2 intensités de soudage préprogrammées et de pouvoir passer facilement de l'une à l'autre (BILEVEL, 4 temps à 2 niveaux).

Polarité du soudage

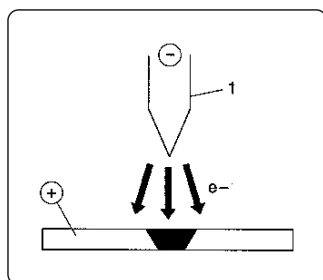

D.C.S.P. (Direct Current Straight Polarity)

Il s'agit de la polarité la plus utilisée (polarité directe ou normale), permettant une usure limitée de l'électrode (1) du fait que 70% de la chaleur se concentre sur l'anode (pièce).

On obtient des bains étroits et profonds avec de grandes vitesses d'avance et donc un apport thermique peu élevé.

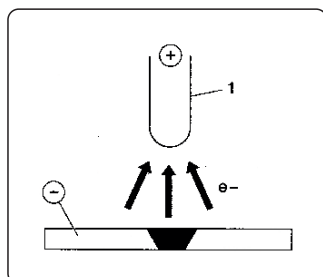

D.C.R.P (Direct Current Reverse Polarity)

La polarité est inverse et cela permet de souder des alliages recouverts par une couche d'oxyde réfractaire avec une température de fusion supérieure à celle du métal.

On ne peut cependant pas employer des courants élevés car ils seraient la cause d'une usure importante de l'électrode.

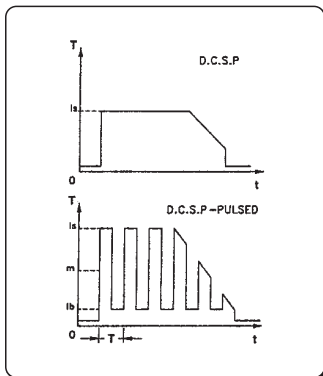
D.C.S.P.-Pulsed (Direct Current Straight Polarity Pulsed)

L'adoption d'un courant continu pulsé permet de mieux contrôler le bain de soudure, en des conditions d'exploitation spéciales.

Le bain de soudure se forme suite aux impulsions de crête (I_p), tandis que le courant de base (I_b) maintient l'arc allumé. Ce procédé facilite le soudage des faibles épaisseurs en obtenant des résultats de soudure avec moindres déformations, un meilleur facteur de marche et par conséquent un danger de fissures chaudes et d'inclusions gazeuses réduit.

Quand on augmente la fréquence (moyenne fréquence), on obtient un arc plus étroit, plus concentré et plus stable, et par la suite une plus grande qualité de la soudure des épaisseurs faibles.

Caractéristiques du soudage TIG

Le procédé TIG est très efficace pour souder de l'acier au carbone ou des alliages, pour la première passe sur les tubes et pour les soudures qui doivent avoir un aspect esthétique parfait.

La polarité directe (D.C.S.P.) est nécessaire dans ce cas.

Préparation des bords

Le procédé impose un nettoyage parfait des bords et une préparation soignée.

Choix et préparation de l'électrode

Il est conseillé d'utiliser des électrodes en tungstène au thorium (2% de thorium couleur rouge) ou bien des électrodes au cérium ou au lanthane avec les diamètres suivants:

Gamme de courant			Électrode	
(DC-)	(DC+)	(AC)	Ø	α
3-20 A	-	3-20 A	0,5 mm	30°
15-80 A	-	20-30 A	1,0 mm	30-60°
70-150 A	10-20 A	30-80 A	1,6 mm	60-90°
150-250 A	15-30 A	60-130 A	2,4 mm	90-120°
250-400 A	25-40 A	100-180 A	3,2 mm	120-150°
400-500 A	40-55 A	160-240 A	4,0 mm	150-180°
500-750 A	55-80 A	190-300 A	4,8 mm	150-180°
750-1100 A	80-125 A	325-450 A	6,4 mm	150-180°

L'électrode doit être affûtée comme indiqué sur le schéma.

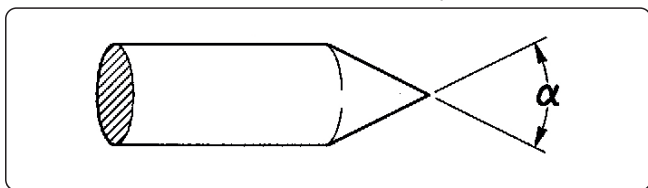
Métal d'apport

Les baguettes d'apport doivent avoir des propriétés mécaniques identiques à celles du matériau de base.

Il est déconseillé d'utiliser des chutes provenant pièce à souder car elles peuvent contenir des impuretés dues à la manipulation et compromettre le soudage.

Gaz de protection

On utilise presque toujours l'Argon pur (99,99%).

Gamme de courant			Gaz	
(DC-)	(DC+)	(AC)	Buse	Flux
3-20 A	-	3-20 A	n° 4	5-6 l/min
15-80 A	-	20-30 A	n° 5	6-8 l/min
70-150 A	10-20 A	30-80 A	n° 6	7-10 l/min
150-250 A	15-30 A	60-130 A	n° 7	8-12 l/min
250-400 A	25-40 A	100-180 A	n° 8	10-14 l/min

FR

Gamme de courant			Gaz	
400-500 A	40-55 A	160-240 A	n° 8	12-16 l/min
500-750 A	55-80 A	190-300 A	n° 10	15-20 l/min
750-1100 A	80-125 A	325-450 A	n° 12	20-25 l/min

10. CARACTÉRISTIQUES TECHNIQUES

Caractéristiques électriques			U.M.
Tension d'alimentation U1 (50/60 Hz)	3x230 (±15%)	3x400 (±15%)	Vac
Zmax (@PCC) *	53	53	mΩ
Fusible retardé	25	16	A
Communication bus	DIGITAL	DIGITAL	
Puissance maximum absorbée	10.5	10.5	kVA
Puissance maximum absorbée	10.1	10.1	kW
Puissance absorbée à l'état inactif	51	51	W
Facteur de puissance (PF)	0.96	0.96	
Rendement (μ)	83	83	%
Cos φ	0.99	0.99	
Courant maximum absorbé I1max	30.8	15.3	A
Courant effectif I1eff	18	9	A
Gamme de réglage	3-270	3-270	A
Tension du moteur de dévidoir Uo	80	80	Vdc
Tension de crête Up	10.1	10.1	kV

* Cet appareil pas conforme à la norme EN / IEC 61000-3-11.

* Ce matériel répond aux normes EN / IEC 61000-3-12 si l'impédance maximum possible du réseau au point d'interface du réseau public (point commun de couplage, PCC) est inférieure ou égale à la valeur donnée "Zmax". S'il est connecté à un réseau public basse tension, il est de la responsabilité de l'installateur ou de l'utilisateur de s'assurer, en consultant l'opérateur de réseau de distribution si nécessaire, que l'appareil peut être connecté.

Facteur d'utilisation	3x230V	3x400V	U.M.
Facteur d'utilisation (40°C)			
(X=35%)	270	270	A
(X=60%)	230	230	A
(X=100%)	180	180	A
Facteur d'utilisation (25°C)			
(X=80%)	270	270	A
(X=100%)	240	240	A

Caractéristiques physiques			U.M.
Degré de protection IP	IP23S		
Classe d'isolation	H		
Dimensions (lxdxh)	500x190x400		mm
Poids	18.8		Kg
Section câble d'alimentation	4x4		mm ²
Longueur du câble d'alimentation	5		m
Normes de construction	EN IEC 60974-1/A1:2019 EN IEC 60974-3:2019 EN 60974-10/A1:2015		

11. PLAQUE DONNÉES

VOESTALPINE BÖHLER WELDING SELCO S.R.L. Via Palladio,19 - ONARA (PADOVA) - ITALY					
URANOS NX 2700 TLH			N°		
		EN 60974-1/A1:2019 IEC 60974-10/A1:2015 Class A		60974-3:2019	
Up 10.1 kV					
3A/10.0V - 270A (270A)/20.8V (20.8V)					
X (40°C)					
35% 60% 100%					
S	U ₀	I _z	270A (270A)	230A (230A)	180A (180A)
	80V	U _z	20.8V (20.8V)	19.2V (19.2V)	17.2V (17.2V)
3A/20.0V - 270A (270A)/30.8V (30.8V)					
X (40°C)					
35% 60% 100%					
S	U ₀	I _z	270A (270A)	230A (230A)	180A (180A)
	80V	U _z	30.8V (30.8V)	29.2V (29.2V)	27.2V (27.2V)
U ₁ 400V(230V)		I _{1max} 15.3A(30.8A)		I _{1eff} 9A(18A)	
IP 23 S					
MADE IN ITALY					

12. SIGNIFICATION DE LA PLAQUE DES DONNÉES

1		2			
3		4			
5		6			
7	9	23			
		11			
8	10	12	15	16	17
		13	15A	16A	17A
		14	15B	16B	17B
7	9	11			
		12	15	16	17
8	10	13	15A	16A	17A
		14	15B	16B	17B
		18	19	20	21
22					
MADE IN ITALY					

- 1 Marque de fabrique
- 2 Nom et adresse du constructeur
- 3 Modèle de l'appareil
- 4 N° de série
- XXXXXXX Année de fabrication
- 5 Symbole du type de générateur
- 6 Référence aux normes de construction
- 7 Symbole du mode de soudage
- 8 Symbole pour les générateurs susceptibles d'être utilisés dans des locaux à fort risque de décharges électriques. I>
- 9 Symbole du courant de soudage
- 10 Tension nominale à vide
- 11 Gamme du courant maximum et minimum et de la tension conventionnelle de charge correspondante.
- 12 Symbole du cycle d'intermittence
- 13 Symbole du courant nominal de soudage
- 14 Symbole de la tension nominale de soudage
- 15 Valeurs du cycle d'intermittence
- 16 Valeurs du cycle d'intermittence
- 17 Valeurs du cycle d'intermittence
- 15A Valeurs du courant nominal de soudage
- 16A Valeurs du courant nominal de soudage
- 17A Valeurs du courant nominal de soudage
- 15B Valeurs de la tension conventionnelle de charge
- 16B Valeurs de la tension conventionnelle de charge
- 17B Valeurs de la tension conventionnelle de charge
- 18 Symbole pour l'alimentation
- 19 Tension nominale d'alimentation
- 20 Courant maximum nominal d'alimentation
- 21 Courant maximum effectif d'alimentation
- 22 Degré de protection
- 23 Tension nominal de pic

CE Déclaration de conformité UE
 EAC Déclaration de conformité EAC
 UKCA Déclaration de conformité UKCA

FR

DECLARACIÓN UE DE CONFORMIDAD

El constructor

voestalpine Böhler Welding Selco S.r.l. - Via Palladio, 19 - 35019 Onara di Tombolo (PD) - ITALY
Tel. +39 049 9413/111 - Fax +39 049 9413/311 - www.voestalpine.com/welding

declara bajo su exclusiva responsabilidad que el siguiente producto:

URANOS NX 2700 TLH 55.07.042
55.07.043

es conforme a las directivas EU:

2014/35/EU LOW VOLTAGE DIRECTIVE

2014/30/EU EMC DIRECTIVE

2011/65/EU RoHS DIRECTIVE

2019/1784/EU EcoDesign

2009/125/EU EcoDesign

y que se han aplicado las siguientes normas armonizadas:

EN IEC 60974-1/A1:2019 WELDING POWER SOURCE

EN IEC 60974-3:2019 ARC STRIKING AND STABILIZING DEVICES

EN 60974-10/A1:2015 ELECTROMAGNETIC COMPATIBILITY REQUIREMENTS

La documentación que acredite el cumplimiento de las directivas se mantendrá disponible para inspecciones en el mencionado fabricante.

Toda reparación, o modificación, no autorizada por voestalpine Böhler Welding Selco S.r.l. hará decaer la validez e invalidará esta declaración.

Onara di Tombolo, 01/07/2024

voestalpine Böhler Welding Selco s.r.l.



Mirco Frasson **Ivo Bonello**

Managing Directors

INDICE

1. ADVERTENCIA	152
1.1 Entorno de utilización	152
1.2 Protección personal y de terceros.....	152
1.3 Protección contra los humos y gases.....	153
1.4 Prevención contra incendios/explosiones.....	154
1.5 Prevención durante el uso de las botellas de gas.....	154
1.6 Protección contra descargaseléctricas	154
1.7 Campos electromagnéticos y interferencias	154
1.8 Grado de protección IP	156
1.9 Eliminación	156
2. INSTALACIÓN	156
2.1 Elevación, transporte y descarga.....	156
2.2 Colocación del equipo	156
2.3 Conexión.....	156
2.4 Instalación.....	157
3. PRESENTACIÓN DEL SISTEMA	158
3.1 Panel posterior.....	158
3.2 Panel de las tomas.....	158
3.3 Panel de mandos frontal.....	159
4. UTILIZACIÓN DEL EQUIPO	160
4.1 Pantalla de inicio.....	160
4.2 Pantalla principal.....	160
4.3 Pantalla principal del proceso MMA.....	160
5. CONFIGURACIÓN.....	164
5.1 Configuración y ajuste de los parámetros.....	164
5.2 Procedimientos específicos de uso de los parámetros.....	171
6. MANTENIMIENTO	175
6.1 Controles periódicos de la fuente de alimentación.....	175
6.2 Responsabilidad.....	175
7. CODIFICACIÓN DE ALARMAS	176
8. DIAGNÓSTICO Y SOLUCIÓN DE PROBLEMAS.....	178
9. INSTRUCCIONES DE USO.....	181
9.1 Soldaduras con electrodo recubierto (MMA).....	181
9.2 Soldadura TIG (arco continuo).....	182
10. CARACTERÍSTICAS TÉCNICAS.....	184
11. PLACA DE DATOS	185
12. SIGNIFICADO DE LA ETIQUETA DE LOS DATOS.....	185
13. ESQUEMA	438
14. CONECTORES.....	440
15. LISTA DE REPUESTOS.....	441

ES

SÍMBOLOS



Advertencia



Prohibiciones



Obligaciones



Indicaciones generales

1. ADVERTENCIA



Antes de comenzar cualquier tipo de operación, tiene que haber comprendido el contenido del presente manual. No efectúe modificaciones ni mantenimientos no descritos en este manual. El fabricante no es responsable por daños a personas o cosas causados por una lectura, o una puesta en aplicación negligente de cuanto escrito del contenido de este manual.

El manual de instrucciones debe permanecer guardado en el lugar de empleo del equipo. Complementariamente al manual de instrucciones, se deben tener en cuenta las reglas válidas a modo general, así como las reglas locales respecto a la prevención de accidentes y la protección medioambiental.

voestalpine Böhler Welding Selco S.r.l. se reserva el derecho de efectuar modificaciones en cualquier momento y sin aviso previo.

Reservados todos los derechos de traducción, reproducción y adaptación total o parcial con cualquier medio (incluidas las copias foto-estáticas, películas y microfilms), sin la autorización escrita por parte de voestalpine Böhler Welding Selco S.r.l.

Los temas tratados en este manual son de vital importancia, y por tanto imprescindibles para poder aplicar las garantías.

Si el operador no se atiende a lo descrito, el fabricante declina cualquier tipo de responsabilidad.



Todas las personas implicadas en la puesta en servicio, el manejo, el mantenimiento y la conservación del equipo deben:

- poseer la cualificación correspondiente
- Poseer conocimientos de soldadura
- Leer completamente y seguir escrupulosamente este manual de instrucciones

En caso de dudas o problemas sobre la utilización del equipo, aunque no se indiquen aquí, consulte con personal cualificado.

ES

1.1 Entorno de utilización



El equipo debe utilizarse exclusivamente para las operaciones para las cuales ha sido diseñado, en los modos y dentro de los campos previstos en la placa de identificación y/o en este manual, según las directivas nacionales e internacionales sobre la seguridad. Un uso diferente del declarado por el fabricante se considera inadecuado y peligroso; en dicho caso, el fabricante no asumirá ninguna responsabilidad.



Este equipo tiene que debe utilizarse sólo para fines profesionales en un local industrial. El fabricante no responde de daños provocados por un uso del equipo en entornos domésticos.



El equipo debe utilizarse en locales con una temperatura comprendida entre -10°C y +40°C (entre +14°F y +104°F). El equipo debe transportarse y almacenarse en locales con una temperatura comprendida entre -25°C y +55°C (entre -13°F y 131°F).

El equipo debe utilizarse en locales sin polvo, ácidos, gases ni otras sustancias corrosivas.

El equipo debe utilizarse en locales con una humedad relativa no superior al 50% a 40°C (104°F).

El equipo debe utilizarse en locales con una humedad relativa no superior al 90% a 20°C (68°F).

El equipo debe utilizarse a una altitud máxima sobre el nivel del mar de 2000 m (6500 pies).



No utilizar dicho aparato para descongelar tubos.

No utilice el equipo para cargar baterías ni acumuladores.

No utilice el equipo para hacer arrancar motores.

1.2 Protección personal y de terceros



El proceso de soldadura es una fuente nociva de radiaciones, ruido, calor y emanaciones gaseosas. Coloque una pared divisoria ignífuga para proteger la zona de soldadura de los rayos, chispas y escorias incandescentes. Advierta a las demás personas que se protejan de los rayos del arco, o del metal incandescente y que no los fijamente.



Póngase prendas de protección para proteger la piel de los rayos del arco y de las chispas, o del metal incandescente. La indumentaria utilizada debe cubrir todo el cuerpo y debe ser:

- íntegra y en buenas condiciones
- ignífuga
- aislante y seca
- ceñida al cuerpo y sin dobleces



Utilice siempre zapatos resistentes y herméticos al agua.



Utilice siempre guantes que garanticen el aislamiento eléctrico y térmico.



Use máscaras con protecciones laterales para la cara y filtro de protección adecuado para los ojos (al menos NR10 o mayor).



Utilice siempre gafas de seguridad con aletas laterales, especialmente cuando tenga que deba retirar manual o mecánicamente las escorias de soldadura.



¡No use lentes de contacto!



Use auriculares si el proceso de soldadura es muy ruidoso. Si el nivel de ruido supera los límites indicados por la ley, delimite la zona de trabajo y cerciórese de que las personas que entren en la misma estén protegidas con auriculares.



Mantenga siempre las tapas laterales cerradas durante los trabajos de soldadura. El equipo no debe ser modificado.



No toque las piezas recién soldadas, el calor excesivo podría provocar graves quemaduras.



Tome todas las medidas de precaución anteriores incluso durante los trabajos de post-soldadura, puesto que de las piezas que se están enfriando podrían saltar escorias.



Compruebe que la antorcha se haya enfriado antes de efectuar trabajos o mantenimientos.



Compruebe que el grupo de refrigeración esté apagado antes de desconectar los tubos de suministro y de retorno del líquido refrigerante. El líquido caliente que sale podría provocar graves quemaduras.



Tenga a mano un equipo de primeros auxilios.
No subestime quemaduras o heridas.



Antes de abandonar el puesto de trabajo, tome todas las medidas de seguridad para dejar la zona de trabajo segura y así impedir accidentes graves a personas o bienes.

1.3 Protección contra los humos y gases



Los humos, gases y polvos producidos por la soldadura pueden ser perjudiciales para la salud.

El humo producido durante la soldadura en determinadas circunstancias, puede provocar cáncer o daños al feto en las mujeres embarazadas.

- Mantenga la cabeza lejos de los gases y del humo de soldadura.
- Proporcione una ventilación adecuada, natural o forzada, en la zona de trabajo.
- En el caso de ventilación insuficiente, utilice mascarillas con respiradores.
- En el caso de soldaduras en lugares angostos, se aconseja que una persona controle al operador desde el exterior.
- No use oxígeno para la ventilación.
- Compruebe la eficacia de la aspiración, comparando periódicamente las emisiones de gases nocivos con los valores admitidos por las normas de seguridad.
- La cantidad y el peligro de los humos producidos dependen del material utilizado, del material de soldadura y de las sustancias utilizadas para la limpieza y el desengrase de las piezas a soldar. Respete escrupulosamente las indicaciones del fabricante y las fichas técnicas.
- No suelde en lugares donde se efectúen desengrases o donde se pinte.
- Coloque las botellas de gas en espacios abiertos, o con una buena circulación de aire.

1.4 Prevención contra incendios/explosiones



El proceso de soldadura puede originar incendios y/o explosiones.

- Retire de la zona de trabajo y de aquella la circundante los materiales, o u objetos inflamables o combustibles.
- Los materiales inflamables deben estar a 11 metros (35 pies) como mínimo del local de soldadura o deben estar protegidos perfectamente.
- Las proyecciones de chispas y partículas incandescentes pueden llegar fácilmente a las zonas de circundantes, incluso a través de pequeñas aberturas. Observe escrupulosamente la seguridad de las personas y de los bienes.
- No suelde encima o cerca de recipientes bajo presión.
- No suelde recipientes o tubos cerrados. Tenga mucho cuidado durante la soldadura de tubos o recipientes, incluso si éstos están abiertos, vacíos y bien limpios. Los residuos de gas, combustible, aceite o similares podrían provocar explosiones.
- No suelde en lugares donde haya polvos, gas, o vapores explosivos.
- Al final de la soldadura, compruebe que el circuito bajo tensión no puede tocar accidentalmente piezas conectadas al circuito de masa.
- Coloque en la cerca de la zona de trabajo un equipo o dispositivo antiincendio.

1.5 Prevención durante el uso de las botellas de gas



Las botellas de gas inerte contienen gas bajo presión y pueden explotar si no se respetan las condiciones mínimas de transporte, mantenimiento y uso.

- Las botellas deben estar sujetas verticalmente a paredes o a otros soportes con elementos adecuados para que no se caigan ni se choquen contra otros objetos.
- Enrosque la tapa de protección de la válvula durante el transporte, la puesta en servicio y cuando concluyan las operaciones de soldadura.
- No exponga las botellas directamente a los rayos solares, a cambios bruscos de temperatura, a temperaturas muy altas o muy bajas. No exponga las botellas a temperaturas muy rígidas ni demasiado altas o bajas.
- Las botellas no deben tener contacto con llamas libres, con arcos eléctricos, antorchas, pinzas portaelectrodos, ni con las proyecciones incandescentes producidas por la soldadura.
- Mantenga las botellas lejos de los circuitos de soldadura y de los circuitos de corriente eléctrica en general.
- Mantenga la cabeza lejos del punto de salida del gas cuando abra la válvula de la botella.
- Cierre la válvula de la botella cuando haya terminado de soldar.
- Nunca suelde sobre una botella de gas bajo presión.
- No conecte una botella de aire comprimido directamente con al reductor de la máquina! Si la presión sobrepasa la capacidad del reductor, éste podría estallar!

1.6 Protección contra descargas eléctricas



Las descargas eléctricas suponen un peligro de muerte.

- No toque las piezas internas ni externas bajo tensión del equipo de soldadura mientras el equipo éste se encuentre activado (antorchas, pinzas, cables de masa, electrodos, alambres, rodillos y bobinas están conectados eléctricamente al circuito de soldadura).
- Compruebe el aislamiento eléctrico del equipo, utilizando superficies y bases secas y aisladas perfectamente del potencia de tierra y de masa de la tierra.
- Compruebe que el equipo esté conectado correctamente a una toma y a una fuente de alimentación dotada de conductor de protección de tierra.
- No toque simultáneamente dos antorchas, o dos pinzas portaelectrodos.
- Interrumpa inmediatamente la soldadura si nota una descarga eléctrica.



El dispositivo de inicio y estabilización del arco se proyecta para el funcionamiento con guía manual o mecánica.



El aumento de la longitud de la antorcha o de los cables de soldadura de más de 8 m aumentará el riesgo de descarga eléctrica.

1.7 Campos electromagnéticos e interferencias



El paso de la corriente a través de los cables internos y externos del equipo crea un campo electromagnético cerca de los cables de soldadura y del mismo equipo.

- Los campos electromagnéticos pueden ser perjudiciales (desconocen los efectos exactos) para la salud de una persona expuesta durante mucho tiempo.

- Los campos electromagnéticos pueden interferir con otros equipos tales como marcapasos o aparatos acústicos.



Las personas con aparatos electrónicos vitales (marcapasos) deberían consultar al médico antes de acercarse al área donde se están efectuando soldaduras por arco.

1.7.1 Clasificación EMC in acuerdo con la Normativa: EN 60974-10/A1:2015.



Le matériel de classe B est conforme aux exigences de compatibilité électromagnétique en milieu industriel et résidentiel, y compris en environnement résidentiel où l'alimentation électrique est distribuée par un réseau public basse tension.



Le matériel de classe A n'est pas conçu pour être utilisé en environnement résidentiel où l'alimentation électrique est distribuée par un réseau public basse tension. Puede ser potencialmente difícil asegurar la compatibilidad electromagnética de los dispositivos de clase A en estas áreas, a causa de las perturbaciones irradiadas y conducidas.

Para más información, consulte el capítulo: PLACA DE DATOS o CARACTERÍSTICAS TÉCNICAS.

1.7.2 Instalación, uso y evaluación del área

Este equipo responde a las indicaciones especificaciones de la norma armonizada EN 60974-10/A1:2015 y se identifica como de "CLASE A". Este equipo tiene que debe utilizarse sólo para fines profesionales en un local industrial. El fabricante no responde de daños provocados por un uso del equipo en entornos domésticos.



El usuario debe ser un experto del sector y como tal es responsable de la instalación y del uso del aparato según las indicaciones del fabricante. Si se detectasen perturbaciones electromagnéticas, el usuario del equipo tendrá que resolver la situación sirviéndose de la asistencia técnica del fabricante.



Debe procurar reducir las perturbaciones electromagnéticas hasta un nivel que no resulte molesto.



Antes de instalar este equipo, el usuario tiene que evaluar los potenciales problemas electro-magnéticos que podrían producirse en la zona circundante y, en particular, la salud de las personas expuestas, por ejemplo: personas con marcapasos y aparatos acústicos.

1.7.3 Requisitos de alimentación de red

Los dispositivos de elevada potencia pueden influir en la calidad de la energía de la red de distribución a causa de la corriente absorbida. Consiguientemente, para algunos tipos de dispositivos (consulte los datos técnicos) pueden aplicarse algunas restricciones de conexión o algunos requisitos en relación con la máxima impedancia de red admitida (Z_{max}) o la mínima potencia de instalación (S_{sc}) disponible en el punto de interacción con la red pública (punto de acoplamiento común - "Point of Common Coupling" PCC). En este caso, es responsabilidad del instalador o del usuario, consultando al gestor de la red si es necesario, asegurarse de que el dispositivo se puede conectar. En caso de interferencia, podría ser necesario tomar adicionales, como por ejemplo colocar filtros en la alimentación de la red.

Además, considere la posibilidad de blindar el cable de alimentación.

Para más información, consulte el capítulo: CARACTERÍSTICAS TÉCNICAS.

1.7.4 Precauciones en el uso de los cables

Para minimizar los efectos de los campos electromagnéticos, respete las siguientes reglas:

- Enrolle juntos y fije, cuando sea posible, el cable de masa y el cable de potencia.
- No se enrolle los cables alrededor del cuerpo.
- No se coloque entre el cable de masa y el cable de potencia (mantenga ambos cables del mismo lado).
- Los cables tienen que ser lo más cortos posible, estar situarse cerca el uno del otro y pasar por encima o cerca del nivel del suelo.
- Coloque el equipo a una cierta distancia de la zona de soldadura.
- Los cables deben estar apartados de otros cables.

1.7.5 Conexión equipotencial

Tenga en cuenta que todos los componentes metálicos de la instalación del equipo de soldadura (corte) y aquéllos los que se encuentran cerca tienen que estar conectados a tierra. Respete las normativas nacionales referentes a la conexión equipotencial.

1.7.6 Puesta a tierra de la pieza de trabajo

Cuando la pieza de trabajo no está conectada a tierra por motivos de seguridad eléctrica, o a debido a sus dimensiones y posición, la conexión a tierra entre la pieza y la tierra de la pieza podría reducir las emisiones. Es importante procurar en que la conexión a tierra de la pieza de trabajo no aumente el riesgo de accidente de los operadores, y que no dañe otros aparatos eléctricos. Respete las normativas nacionales referentes a la conexión a tierra.

1.7.7 Blindaje

El blindaje selectivo de otros cables y aparatos presentes en la zona circundante puede reducir los problemas de interferencia. En caso de aplicaciones especiales, también puede considerarse el blindaje de todo el equipo de soldadura.

1.8 Grado de protección IP



IP23S

- Para evitar el contacto de los dedos con partes peligrosas y la entrada de cuerpos sólidos extraños de diámetro mayor/igual a 12.5 mm.
- Envoltura protegida contra la lluvia a 60° sobre la vertical.
- Envoltura protegida contra los efectos perjudiciales debidos a la entrada de agua, cuando las partes móviles del aparato no están en movimiento.

1.9 Eliminación



¡No arroje nunca el equipo eléctrico entre los residuos comunes!

Con arreglo a la Directiva Europea 2012/19/UE sobre Residuos de Aparatos Eléctricos y Electrónicos y su implementación de acuerdo con las leyes nacionales, los aparatos eléctricos que hayan llegado al final de su ciclo de vida deben recogerse por separado y enviarse a un centro de recuperación y eliminación. El propietario del aparato debe identificar los centros de recogida autorizados consultando con las Administraciones Locales. La aplicación de la Directiva Europea permitirá mejorar el medio ambiente y la salud humana.

» Para más información, consulte el sitio web.

2. INSTALACIÓN



La instalación debe efectuarla solamente personal experto y habilitado por el fabricante.



Durante la instalación compruebe que el la fuente de alimentación esté desconectada de la toma de corriente.



La conexión de los fuentes de alimentación en serie o en paralelo está prohibida.

2.1 Elevación, transporte y descarga

- El equipo incorpora un asa que permite desplazarlo a mano.



No subestime el peso del equipo, consulte las características técnicas.
No traslade ni detenga la carga encima de personas u objetos.
No aplique una presión excesiva sobre el equipo.

2.2 Colocación del equipo



Observe las siguientes normas:

- El acceso a los mandos y conexiones tiene que ser fácil.
- No coloque el equipo en lugares estrechos.
- No coloque nunca el equipo sobre una superficie con una inclinación superior a 10° respecto del plano horizontal.
- Coloque el equipo en un lugar seco, limpio y con ventilación apropiada.
- Proteja la instalación de la lluvia y del sol.

2.3 Conexión



El equipo incluye un cable de alimentación para la conexión a la red.

El equipo puede alimentarse con:

- 230V trifásica
- 400V trifásica

El funcionamiento del equipo está garantizado para tensiones que se alejan de hasta el $\pm 15\%$ del valor nominal.



Para evitar daños a las personas o a la instalación, es necesario controlar la tensión de red seleccionada y los fusibles ANTES de conectar la máquina a la red. Compruebe también que el cable esté conectado a una toma con contacto de tierra.



Es posible alimentar el equipo mediante un grupo electrógeno, siempre que garantice una tensión de alimentación estable entre el $\pm 15\%$ respecto del valor de la tensión nominal declarado por el fabricante, en todas las condiciones de funcionamiento posibles y con la máxima potencia suministrable por el generador nominal. Por lo general, se aconseja utilizar grupos electrógenos de potencia con el doble de potencia de la fuente de alimentación si es monofásica, y equivalente a 1,5 veces si es trifásica. Se aconseja la utilización de grupos electrógenos con controlador electrónico.



Para la protección de los usuarios, el equipo debe estar correctamente conectado a tierra. El cable de alimentación cuenta con un conductor (amarillo - verde) para la puesta a tierra, que debe ser conectarse a una clavija con contacto de tierra. NUNCA use el cable amarillo/verde junto con otro cable para tomar la corriente. Compruebe que el equipo disponga de conexión a tierra y que las tomas de corriente estén en buenas condiciones. Instale sólo enchufes homologados de acuerdo con las normativas de seguridad.



La instalación eléctrica debe efectuarla personal técnico con requisitos técnico profesionales específicos y de conformidad con las leyes del país en el cual se efectúa la instalación.

2.4 Instalación

2.4.1 Conexión para la soldadura MMA



La conexión que muestra la figura da como resultado una soldadura con polaridad invertida. Para obtener una soldadura con polaridad directa, invierta la conexión.

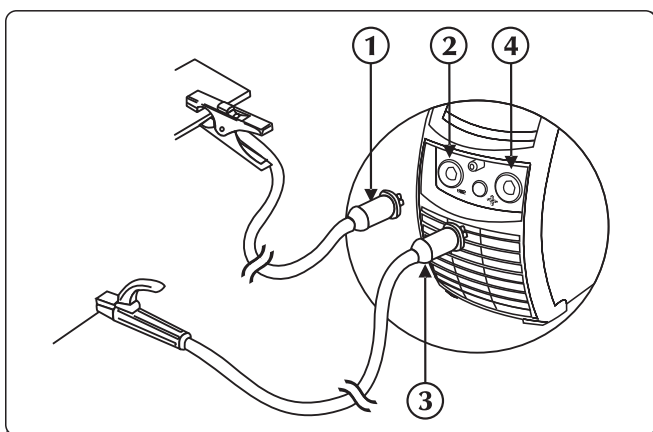

- ① Conector de la pinza de masa
- ② Toma negativa de potencia (-)
- ③ Conector de la pinza portaelectrodos
- ④ Toma positiva de potencia (+)

- ▶ Conecte el conector del cable de la pinza de masa a la toma negativa (-) del generador. Inserte la clavija y gire hacia la derecha que todas las piezas queden fijadas.
- ▶ Conecte el conector del cable de la pinza portaelectrodo a la toma positiva (+) del generador. Inserte la clavija y gire hacia la derecha que todas las piezas queden fijadas.

2.4.2 Conexión para la soldadura TIG

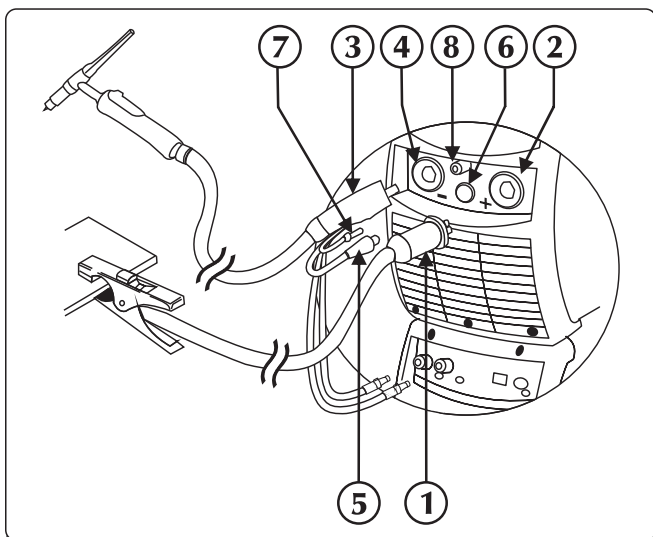

- ① Conector de la pinza de masa
- ② Toma positiva de potencia (+)
- ③ Conexión de la antorcha TIG
- ④ Toma de antorcha
- ⑤ Cable de señal de antorcha
- ⑥ Conectore
- ⑦ Tubo de gas antorcha
- ⑧ Conexión/unión de gas

- ▶ Conecte el conector del cable de la pinza de masa a la toma positiva (+) del generador. Inserte la clavija y gire hacia la derecha que todas las piezas queden fijadas.
- ▶ Conecte la unión de la antorcha TIG a la toma de la antorcha del generador. Inserte la clavija y gire hacia la derecha que todas las piezas queden fijadas.
- ▶ Conecte el cable de señal de la antorcha al conector apropiado.
- ▶ Connecter le tuyau gaz de la torche à la connexion appropriée.
- ▶ Conecte el tubo de retorno del líquido refrigerante agua de color rojo de la antorcha al conector de entrada de la unidad de refrigeración (color rojo - símbolo ).

ES

► Conecte el tubo de alimentación del líquido refrigerante agua de color azul de la antorcha al conector de salida de la unidad de refrigeración (color azul - símbolo).

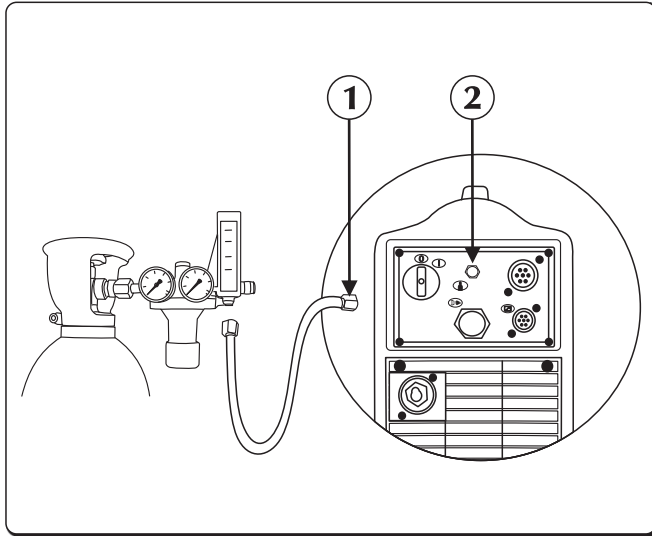

- ① Tubo de gas
- ② Conexión/unión de gas

► Conecte el tubo de gas que proviene de la botella al racor de gas posterior. Ajuste el flujo de gas de 5 a 15 l/min.

3. PRESENTACIÓN DEL SISTEMA

3.1 Panel posterior

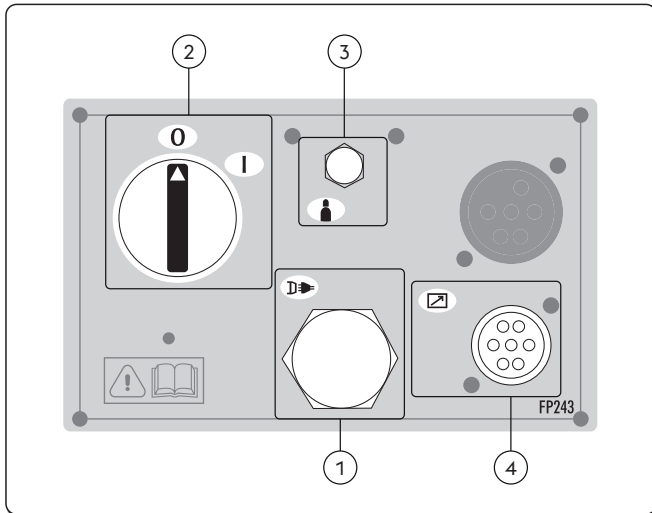

- ① Cable de alimentación.
Conecta el sistema a la red.
- ② Conmutador de activación
Acciona el encendido eléctrico del equipo.
Tiene dos posiciones "O" desactivado; "I" activado.
- ③ Conexión de gas
- ④ Entrada de cable de señal CAN-BUS (RC, RI...)



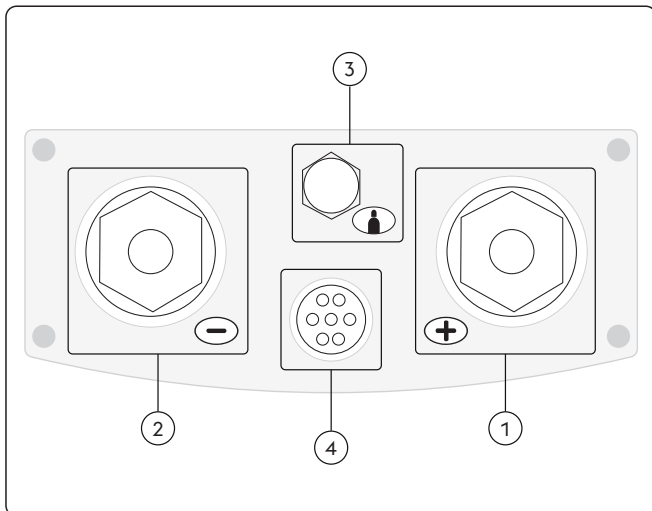



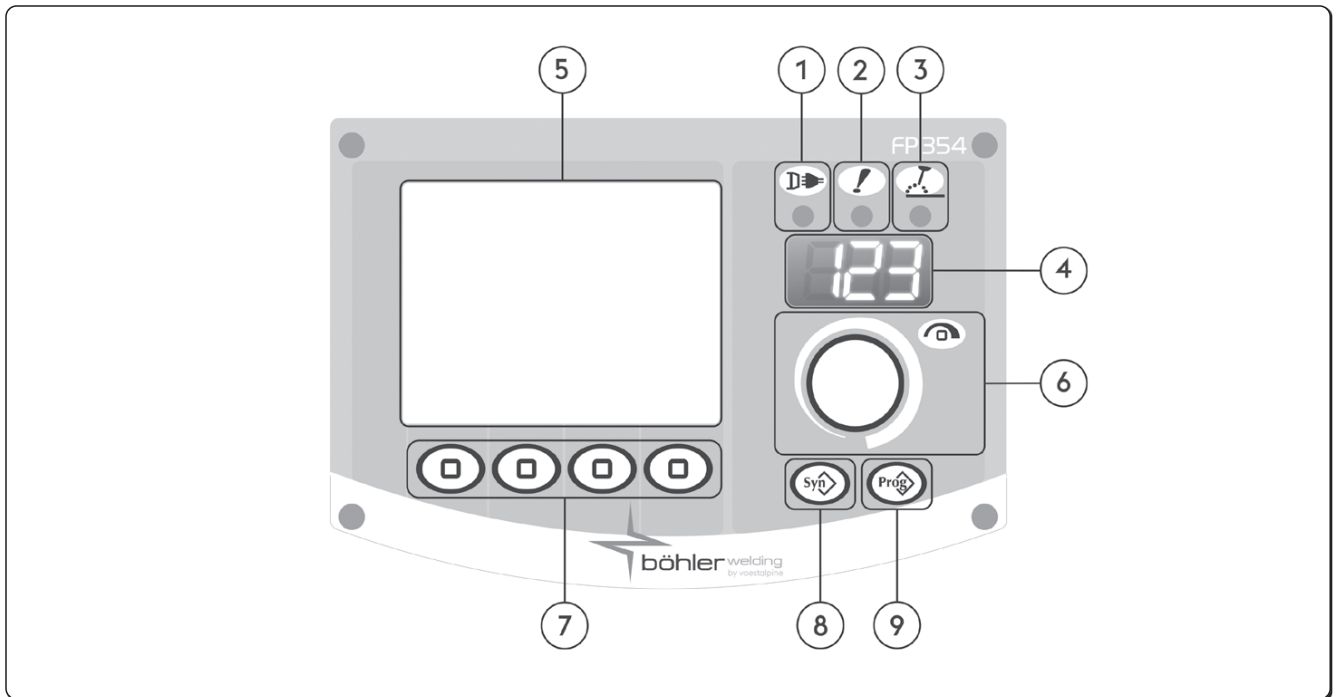

3.2 Panel de las tomas



- ① Toma positiva de potencia (+)
Proceso MMA: Conexión antorcha de electrodos
Proceso TIG: Conexión cable de tierra
- ② Toma negativa de potencia (-)
Proceso MMA: Conexión cable de tierra
Proceso TIG: Conexión de la antorcha
- ③ Conexión de gas
- ④ Entrada del cable de señal (Antorcha TIG)

3.3 Panel de mandos frontal



- 1  **Led de encendido**
Indica que el equipo está conectado a la red y está activado.
- 2  **Led de alarma general**
Indica la posible intervención de dispositivos de protección como la protección de temperatura.
- 3  **Led de potencia activa**
Indica la presencia de tensión en las conexiones de la toma del equipo.
- 4  **Pantalla de 7 segmentos**
Permite que se visualicen los parámetros generales de soldadura de la máquina durante el arranque, los ajustes, las lecturas de corriente y tensión, durante la soldadura, y en la codificación de las alarmas.
- 5  **Pantalla LCD**
Permite que se visualicen los parámetros generales de soldadura de la máquina durante el arranque, los ajustes, las lecturas de corriente y tensión, durante la soldadura, y en la codificación de las alarmas.
Permite visualizar instantáneamente todas las operaciones.
- 6  **Encoder**
Permite ajustar la corriente de soldadura de forma continua.
Permite que la entrada se configure, así como la selección y la configuración de los parámetros de soldadura.
- 7  **Botones de función**
Permiten seleccionar las diferentes funciones del equipo:
- Procédé de soudage
- Sequencia del micro interruptor
- Tipos de corriente
- Modalidad gráfica
- 8  **Botón no utilizado**
- 9  **Botón job**
Permite memorizar y gestionar 240 job personalizables por el usuario.

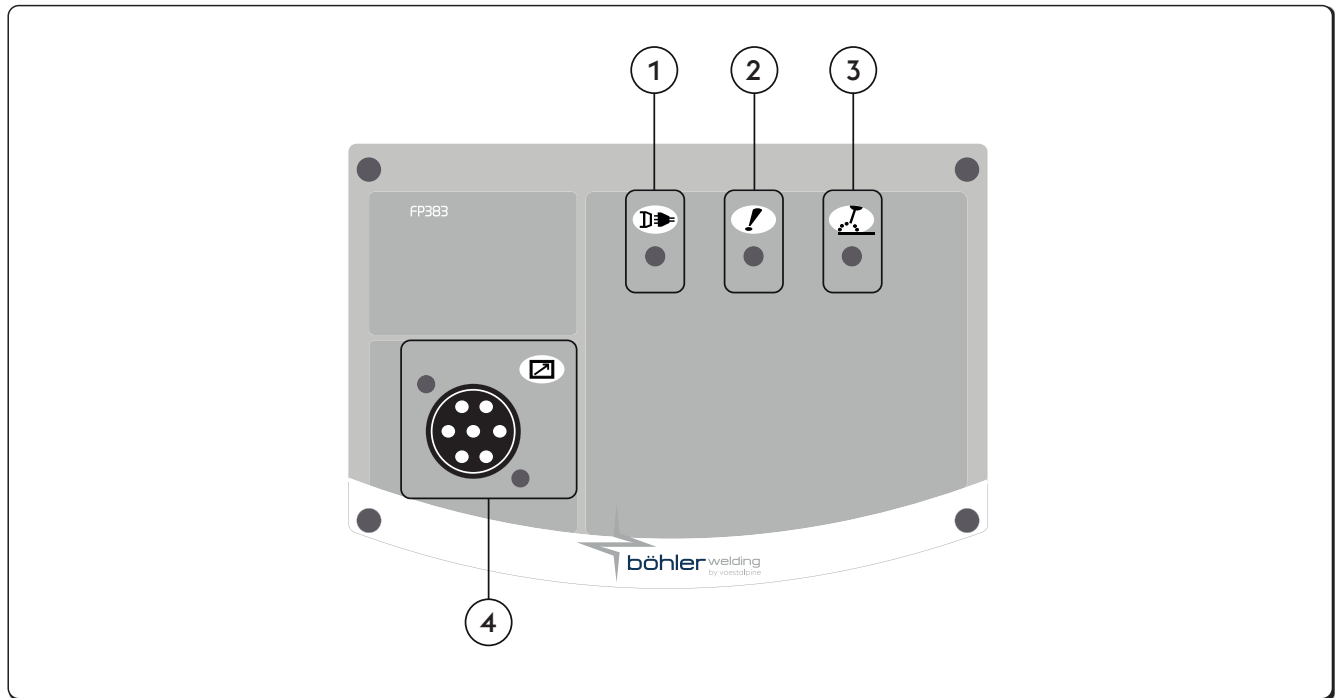

ES

- ① **Led de encendido**
Indica que el equipo está conectado a la red y está activado.
- ② **Led de alarma general**
Indica la posible intervención de dispositivos de protección como la protección de temperatura.
- ③ **Led de potencia activa**
Indica la presencia de tensión en las conexiones de la toma del equipo.
- ④ **Entrada de cable de señal CAN-BUS (RC, RI...)**

4. UTILIZACIÓN DEL EQUIPO

4.1 Pantalla de inicio

Cuando se enciende, el equipo realiza una serie de comprobaciones para garantizar su correcto funcionamiento y el de todos los dispositivos conectados al mismo. En esta fase también se realiza la prueba de gas para establecer la correcta conexión con el sistema de alimentación del gas.

4.2 Pantalla principal

Permite la gestión del equipo y del proceso de soldadura, mostrando los ajustes principales.

4.3 Pantalla principal del proceso MMA

- ① **Medidas**
- ② **Parámetros de soldadura**
- ③ **Funciones**

Medidas

Durante las fases de soldadura, se visualizan en la pantalla LCD los valores reales de corriente y de tensión.

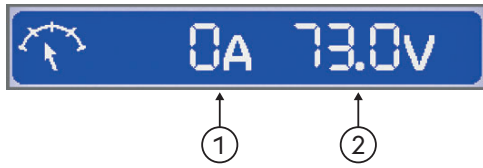

- ① Corriente de soldadura
- ② Tensión de soldadura

Parámetros de soldadura

► Seleccione el parámetro deseado pulsando la tecla encoder.

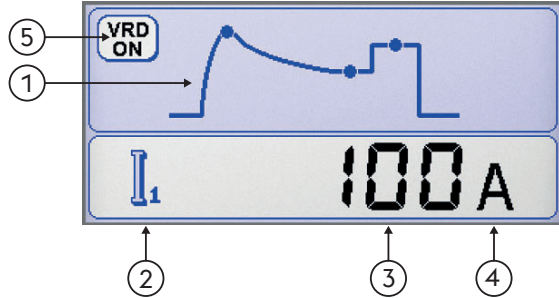

- ① Parámetros de soldadura
- ② Icono del parámetro
- ③ Valor del parámetro
- ④ Unidad de medida del parámetro
- ⑤ VRD (Voltage Reduction Device)
Dispositivo de reducción de tensión
Señala que la tensión en vacío del equipo está controlado.

Funciones

Permiten el ajuste de las funciones de proceso y del modo de soldadura más importantes.

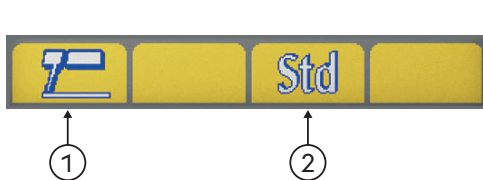

- ① Procédé de soudage
- ② Sinergia MMA



Procédé de soudage

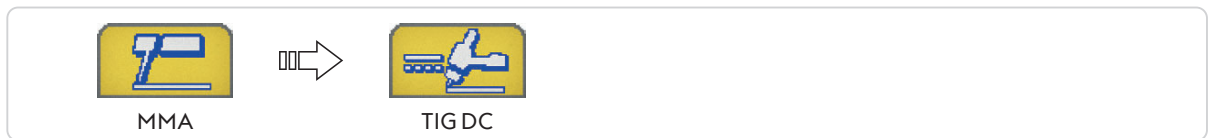

Sinergia MMA

Permite configurar la mejor dinámica de arco seleccionando el tipo de electrodo utilizado.

Si selecciona una dinámica de arco correcta podrá aprovechar al máximo el equipo con el objetivo de obtener las mejores prestaciones posibles en soldadura.



No se garantiza una soldadura perfecta del electrodo utilizado.

La soldadura depende de la calidad de los consumibles y de su conservación, de los modos operativos y de las condiciones de soldadura, de las numerosas aplicaciones posibles...

4.4 Pantalla principal del proceso TIG

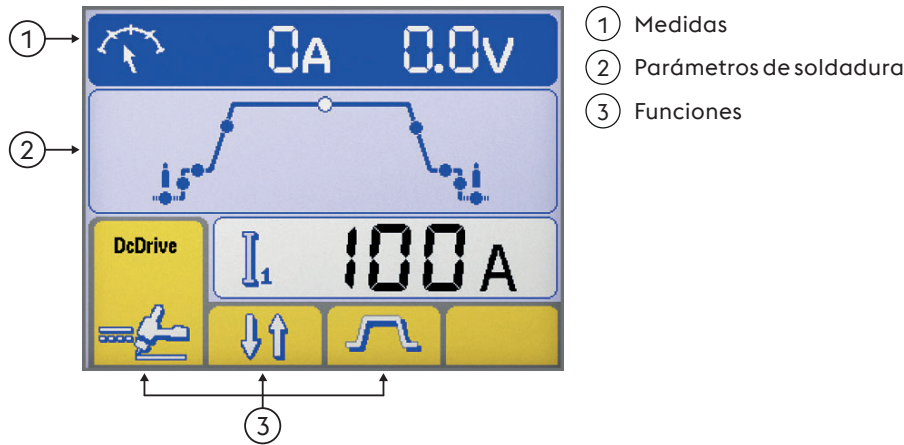

- ① Medidas
- ② Parámetros de soldadura
- ③ Funciones

Medidas

Durante las fases de soldadura, se visualizan en la pantalla LCD los valores reales de corriente y de tensión.

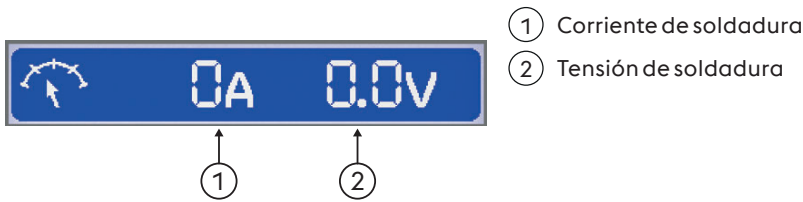

- ① Corriente de soldadura
- ② Tensión de soldadura

ES

Parámetros de soldadura

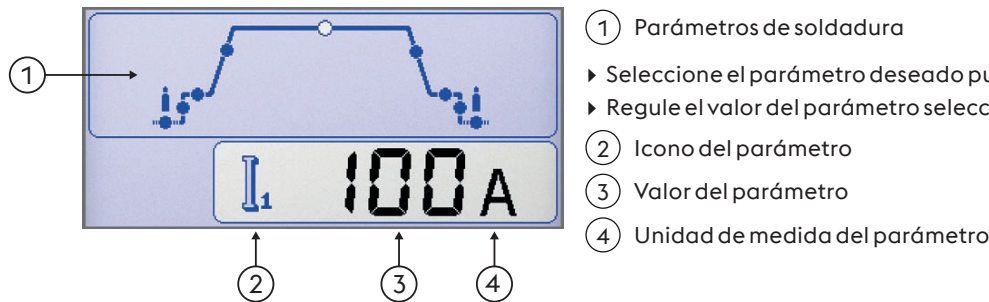

- ① Parámetros de soldadura
 - ▶ Seleccione el parámetro deseado pulsando la tecla encoder.
 - ▶ Regule el valor del parámetro seleccionado girando el encoder.
- ② Icono del parámetro
- ③ Valor del parámetro
- ④ Unidad de medida del parámetro

Funciones

Permiten el ajuste de las funciones de proceso y del modo de soldadura más importantes.

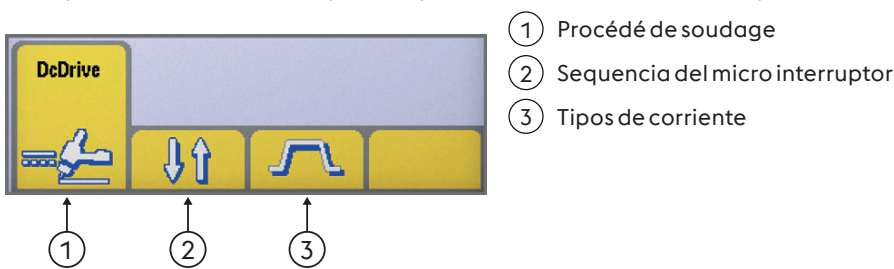

- ① Procédé de soudage
- ② Sequencia del micro interruptor
- ③ Tipos de corriente

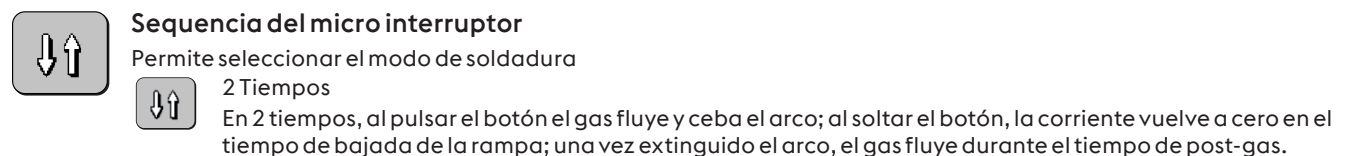



4 Tiempos

En 4 tiempos, la primera presión del botón hace que fluya el gas, realizando un pre-gas manual; cuando se suelta, se ceba el arco.



Bilevel

En bilevel, el soldador puede soldar con dos corrientes diferentes configuradas anteriormente. La primera presión del botón conlleva el tiempo de pre-gas, el cebado del arco y la soldadura con la corriente inicial. Al soltar el botón por primera vez pasamos a la rampa de subida de corriente "I1". Si el soldador pulsa y suelta el botón rápidamente, se produce un cambio en "I2". Si pulsa y suelta el botón rápidamente vuelve a "I1", etcétera. Si se aprieta durante un tiempo más largo, inicia la rampa de descenso de la corriente hasta la corriente final. Si suelta el botón se extingue el arco, mientras que el gas continúa fluyendo durante el tiempo de post-gas.



Tipos de corriente



Corriente constante



Corriente de impulsos



Fast Pulse



EasyArc

4.5 Pantalla de programas



Permite memorizar y gestionar 240 job personalizables por el usuario.

Programas (JOB)

Consulte la sección "Pantalla principal"

Memorizar programas

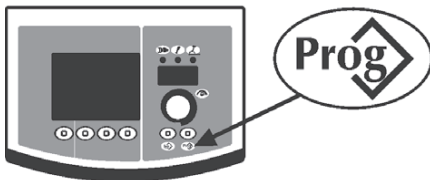

- ▶ Entre en la pantalla "memorización programa" pulsando la tecla durante al menos un segundo.



- ▶ Seleccione el programa (o la memoria vacía) deseado girando el encoder.

--- Memoria vacía

Programa memorizado

- ▶ Anule la operación pulsando la tecla .
- ▶ Guarde todos los ajustes actuales en el programa seleccionado pulsando la tecla .

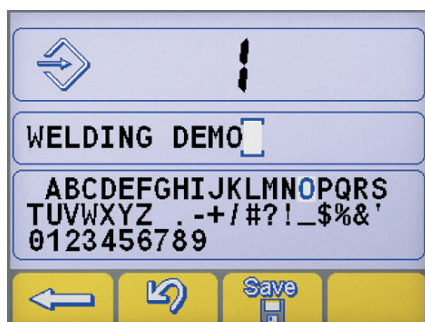

Introduzca una descripción del programa.

- ▶ Seleccione la letra deseada girando el encoder.
- ▶ Memorice la letra seleccionada pulsando el encoder.
- ▶ Cancele la última letra pulsando la tecla .
- ▶ Anule la operación pulsando la tecla .
- ▶ Anule la operación pulsando la tecla .



La memorización de un nuevo programa en una memoria ya ocupada implica la cancelación de la memoria mediante un procedimiento obligatorio.



- ▶ Anule la operación pulsando la tecla
- ▶ Elimine el programa seleccionado pulsando la tecla
- ▶ Reanude el procedimiento de memorización.

Recuperar programas

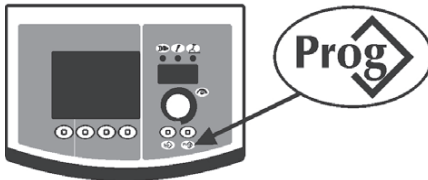

- ▶ Recupere el 1er programa disponible pulsando la tecla
- ▶ Seleccione el programa deseado girando el encoder.
- ▶ Seleccione el programa deseado pulsando la tecla



Se recupera sólo la memoria ocupada por un programa, mientras que las vacías se omiten automáticamente.

Cancelar programa



- ▶ Seleccione el programa deseado girando el encoder.
- ▶ Elimine el programa seleccionado pulsando la tecla
- ▶ Anule la operación pulsando la tecla



- ▶ Anule la operación pulsando la tecla
- ▶ Elimine el programa seleccionado pulsando la tecla

ES

5. CONFIGURACIÓN

5.1 Configuración y ajuste de los parámetros

Permite la configuración y el ajuste de una serie de parámetros adicionales para garantizar un mejor y más preciso control del sistema de soldadura.

Los parámetros presentes en la configuración están organizados según el proceso de soldadura seleccionado y tienen una codificación numérica.

Entrada a la configuración





- ▶ Se produce pulsando durante 5 segundos la tecla encoder.
- ▶ La entrada será confirmada con un 0 en la pantalla.

Selección y ajuste del parámetro deseado

- ▶ El parámetro se selecciona girando el encoder hasta visualizar el código numérico relativo al parámetro deseado.
- ▶ Si pulsa la tecla encoder en este momento, podrá ver y ajustar el valor definido para el parámetro seleccionado.

Salida de la "configuración"

- ▶ Para salir de la sección "ajuste", pulse nuevamente el encoder.
- ▶ Para salir de la configuración, pase al parámetro "0" (guardar y salir) y pulse la tecla encoder.
- ▶ Anule la operación pulsando la tecla .
- ▶ Para guardar la modificación y salir de la configuración, pulse el botón: .

5.1.1 Lista de los parámetros de la configuración (MMA)

0 Guardar y salir



Permite guardar las modificaciones y salir de la configuración.

1 Reset



Permite recuperar los valores por defecto de todos los parámetros.

3 Hot start



Permite ajustar el valor de hot start en MMA.

Permite un arranque más o menos "caliente" durante el cebado del arco, facilitando las operaciones de comienzo de la soldadura.

Electrodos básico

Mínimo	Máximo	Por defecto
0/off	500%	80%

Electrodos celulósico

Mínimo	Máximo	Por defecto
0/off	500%	150%

Electrodos CrNi

Mínimo	Máximo	Por defecto
0/off	500%	100%

Electrodos de aluminio

Mínimo	Máximo	Por defecto
0/off	500%	120%

Electrodos de hierro fundido

Mínimo	Máximo	Por defecto
0/off	500%	100%

Electrodo de rutilo

Mínimo	Máximo	Por defecto
0/off	500%	80%

7 Corriente de soldadura

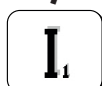

Permite ajustar la corriente de soldadura.

Mínimo	Máximo	Por defecto
3 A	I _{max}	100 A

8 Arc force



Permite ajustar el valor del Arc force en MMA.

Permite una respuesta dinámica, más o menos energética, durante la soldadura facilitando el trabajo del soldador.

Aumentar el valor del Arc force para reducir los riesgos de adhesión del electrodo.

Electrodos básico

Mínimo	Máximo	Por defecto
0/off	500%	30%

Electrodos celulósico

Mínimo	Máximo	Por defecto
0/off	500%	350%

Electrodos CrNi

Mínimo	Máximo	Por defecto
0/off	500%	30%

Electrodos de aluminio

Mínimo	Máximo	Por defecto
0/off	500%	100%

Electrodos de hierro fundido

Mínimo	Máximo	Por defecto
0/off	500%	70%

Electrodo de rutilo

Mínimo	Máximo	Por defecto
0/off	500%	80%

ES

204 Dynamic power control (DPC)



Permite la selección de la característica V/I deseada.

I=C Corriente constante

El aumento o la reducción de la altura del arco no tiene ninguna influencia sobre la corriente de soldadura generada.

Recomendado para electrodo: Básico, Rutilo, Ácido, Acero inox, Hierro colado

1÷20 Característica declinante con regulación de rampa

El aumento de la altura del arco provoca la reducción de la corriente de soldadura (y viceversa) según el valor ajustado de 1 a 20 Amperios para cada Voltio.

Recomendado para electrodo: Celulosico, Aluminio

P=C Potencia constante

El aumento de la altura del arco provoca la reducción de la corriente de soldadura (y viceversa) según la fórmula $V \cdot I = K$

Recomendado para electrodo: Celulosico, Aluminio

312 Tensión de desprendimiento del arco



Permite ajustar el valor de tensión al que se fuerza la desactivación del arco eléctrico.

Permite una gestión mejorada de las diferentes condiciones de funcionamiento que se crean.

Por ejemplo, durante la soldadura por puntos, una baja tensión de desprendimiento del arco reduce las llamas al alejarse el electrodo de la pieza reduciendo las salpicaduras, quemaduras y la oxidación de la pieza.



Nunca ajuste una tensión de desprendimiento del arco mayor que la tensión en vacío de la fuente de alimentación.

Electrodos básico

Mínimo	Máximo	Por defecto
0/off	Vmax	57.0 V

Electrodos celulósico

Mínimo	Máximo	Por defecto
0/off	Vmax	70.0 V

399 Velocidad de desplazamiento



Permite configurar la velocidad de ejecución de la soldadura.

Default cm/min: velocidad de referencia para la soldadura manual.

Syn: valor sinérgico.

Mínimo	Máximo	Por defecto
2 cm/min	200 cm/min	15 cm/min

500 Configuración de la máquina



Permite seleccionar el interface gráfico deseado.

Permite acceder a los niveles superiores de la configuración.

Consulte la sección "Personalizar el interfaz (Set up 500)"

Valeur	Nivel seleccionado
USER	Usuario
SERV	Servicio
vaBW	vaBW

Valeur	Interfaz Usuario
XE	Modo Easy
XA	Modo Advanced
XP	Modo Professional

551 Lock/unlock



Permite bloquear los comandos del panel e introducir un código de protección.

Consulte la sección "Lock/unlock (Set up 551)".

552 Tono zumbador



Permite ajustar el tono del zumbador.

Mínimo	Máximo	Por defecto
0/off	10	10

601 Paso de regulación



Permite regular un parámetro con paso personalizable del operario.

Mínimo	Máximo	Por defecto
1	Imax	1

602 Parámetro externo 2



Permite la gestión del parámetro externo 2 (valor mínimo, valor máximo, valor por defecto, parámetro seleccionado).

705 Ajuste resistencia del circuito
 Permite ajustar el equipo.
 Consulte la sección "Ajuste resistencia del circuito (set up 705)".



751 Lectura de corriente
 Permite visualizar el valor real de la corriente de soldadura.



752 Lectura de tensión
 Permite visualizar el valor real de la tensión de soldadura.



768 Medición del aporte térmico HI
 Permite leer el valor de la medida del aporte térmico en la soldadura.



5.1.2 Lista de los parámetros de configuración (TIG)

0 Guardar y salir
 Permite guardar las modificaciones y salir de la configuración.



1 Reset
 Permite recuperar los valores por defecto de todos los parámetros.



2 Pre gas
 Permite ajustar y regular el flujo de gas antes del cebado del arco.
 Permite la salida del gas en la antorcha y la preparación del ambiente entorno para la soldadura.



Mínimo	Máximo	Por defecto
0/off	99.9 s	0.1 s

3 Corriente inicial
 Permite regular la corriente de inicio de soldadura.
 Permite obtener un baño de soldadura con algo de calor en las fases inmediatamente posteriores al inicio.



Mínimo	Máximo	Por defecto	Mínimo	Máximo	Por defecto
1%	200%	50%	3 A	I _{max}	-

5 Tiempo de la corriente inicial
 Permite ajustar el tiempo en el cual se mantiene la corriente inicial.



Mínimo	Máximo	Por defecto
0/off	99.9 s	0/off

6 Rampa de subida
 Permite configurar un paso gradual entre la corriente inicial y la corriente de soldadura.



Mínimo	Máximo	Por defecto
0/off	99.9 s	0/off

7 Corriente de soldadura
 Permite ajustar la corriente de soldadura.



Mínimo	Máximo	Por defecto
3 A	I _{max}	100 A

8 Corriente Bilevel (dos niveles)



Permite ajustar la corriente secundaria en el modo de soldadura Bilevel.

A la primera presión del pulsador portaelectrodos se obtiene el pre-gas, el cebado del arco y la soldadura con corriente inicial.

Cuando se suelta por primera vez, se obtiene la rampa de subida hasta la corriente "I1".

Si el soldador aprieta y suelta rápidamente el pulsador se pasa a "I2".

Volviendo a apretar y soltar rápidamente el pulsador, se pasa a "I1" y así sucesivamente.

Si se aprieta durante un tiempo más largo, inicia la rampa de descenso de la corriente hasta la corriente final.

Soltando el pulsador se obtiene el apagado del arco y el gas sigue fluyendo durante el tiempo de post-gas.

Mínimo	Máximo	Por defecto	Mínimo	Máximo	Por defecto
3 A	I _{max}	-	1%	500%	off

10 Corriente de base



Permite ajustar la corriente de base en modo de impulsos y "fast pulse".

Mínimo	Máximo	Por defecto	Mínimo	Máximo	Por defecto
3 A	I _{sald}	-	1%	100%	50%

12 Frecuencia de impulsos



Permite regular la frecuencia de pulsación.

Permite obtener mejores resultados en la soldadura de grosores reducidos y una calidad estética superior del cordón.

Mínimo	Máximo	Por defecto
0.1 Hz	25 Hz	5 Hz

13 Ciclo de trabajo de impulsos



Permite regular el duty cycle en pulsado.

Permite el mantenimiento de la corriente de pico durante un tiempo considerable.

Mínimo	Máximo	Por defecto
1 %	99 %	50 %

14 Frecuencia Fast Pulse



Permite regular la frecuencia de pulsación.

Permite obtener una mayor concentración y una mejor estabilidad del arco eléctrico.

Mínimo	Máximo	Por defecto
0.02 KHz	2.5 KHz	0.25 KHz

15 Rampas de impulsos



Permite ajustar un tiempo de rampa en la fase de pulsación.

Permite obtener una transición gradual entre la corriente de pico y la corriente de base, permitiendo así un arco relativamente "ligero".

Mínimo	Máximo	Por defecto
0/off	100 %	0/off

16 Rampa bajada



Permite configurar un paso gradual entre la corriente de soldadura y la corriente final.

Mínimo	Máximo	Por defecto
0/off	99.9 s	0/off

17 Corriente final



Permite ajustar la corriente final.

Mínimo	Máximo	Por defecto	Mínimo	Máximo	Por defecto
3 A	I _{max}	10 A	1 %	200 %	50 %

19 Tiempo de la corriente final



Permite ajustar el tiempo en el cual se mantiene la corriente final.

Mínimo	Máximo	Por defecto
0/off	99.9 s	0/off

20 Post-gas



Permite ajustar el flujo de gas al final de la soldadura.

Mínimo	Máximo	Por defecto
0/off	99.9 s	syn

203 Tig start (HF)

Permite la selección del modo de inicio deseado.

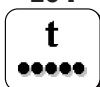
Valeur	Por defecto	Función de devolución de llamada
on	X	HF START
off	-	LIFT START

204 Soldadura por puntos

Permite activar el proceso de "soldadura por puntos" y establecer el tiempo de soldadura.

Permite la temporización del proceso de soldadura.

Mínimo	Máximo	Por defecto
0/off	99.9 s	0/off

205 Re-start

Permite activar la función restart.

Permite la extinción inmediata del arco durante la rampa de descenso o la reanudación del ciclo de soldadura.

Valeur	Por defecto	Función de devolución de llamada
0/off	-	off
1/on	X	on
2/of1	-	off

206 Easy joining

Permite el inicio del arco en corriente pulsada y la temporización de la función antes del restablecimiento automático de las condiciones de soldadura predefinidas.

Permite una mayor rapidez y precisión en las operaciones de soldadura por puntos de las piezas.

Mínimo	Máximo	Por defecto
0.1 s	25.0 s	0/off

208 Microtime spot welding

Permite habilitar el proceso de "microtime spot welding".

Permite la temporización del proceso de soldadura.

Mínimo	Máximo	Por defecto
0.01 s	1.00 s	0/off

399 Velocidad de desplazamiento

Permite configurar la velocidad de ejecución de la soldadura.

Default cm/min: velocidad de referencia para la soldadura manual.

Syn: valor sinérgico.

Mínimo	Máximo	Por defecto
2 cm/min	200 cm/min	10 cm/min

500 Configuración de la máquina

Permite seleccionar el interface gráfico deseado.

Permite acceder a los niveles superiores de la configuración.

Consulte la sección "Personalizar el interfaz (Set up 500)"

Valeur	Nivel seleccionado	Valeur	Interfaz Usuario
USER	Usuario	XE	Modo Easy
SERV	Servicio	XA	Modo Advanced
vaBW	vaBW	XP	Modo Professional

551 Lock/unlock



Permite bloquear los comandos del panel e introducir un código de protección. Consulte la sección "Lock/unlock (Set up 551)".

552 Tono zumbador



Permite ajustar el tono del zumbador.

Mínimo	Máximo	Por defecto
0/off	10	10

601 Paso de regulación



Permite regular un parámetro con paso personalizable del operario.

Mínimo	Máximo	Por defecto
1	Imax	1

602 Parámetro externo CH1, CH2, CH3, CH4



Permite la gestión del parámetro externo 1, 2, 3, 4 (valor mínimo, valor máximo, valor por defecto, parámetro seleccionado).

Consulte la sección "Gestión de comandos externos (Set up 602)".

606 Antorcha U/D



Permite la gestión del parámetro externo (U/D).

Valeur	Por defecto	Función de devolución de llamada
0/off	-	off
1/11	X	Corriente
	-	Recuperar programas

612 Ajuste Antorcha DgTig



Permite la gestión de los canales de la antorcha digital.

Valeur	Por defecto	Función de devolución de llamada
0/off	-	off
1/11	-	Corriente
2/	-	Recuperar programas
3/CH3	-	CH3
4/CH4	-	CH4
5/STD	X	STD

705 Ajuste resistencia del circuito



Permite ajustar el equipo.

Consulte la sección "Ajuste resistencia del circuito (set up 705)".

751 Lectura de corriente



Permite visualizar el valor real de la corriente de soldadura.

752 Lectura de tensión



Permite visualizar el valor real de la tensión de soldadura.

758 Velocidad de desplazamiento del robot



Permite visualizar la velocidad de desplazamiento del brazo de un robot o de una automatización.

764 Lectura del flujo del líquido refrigerante

Permite visualizar el valor del líquido refrigerante.

765 Lectura de temperatura del líquido refrigerante

Permite visualizar el valor real de la temperatura del líquido refrigerante.

768 Medición del aporte térmico HI

Permite leer el valor de la medida del aporte térmico en la soldadura.

801 Límites de seguridad

Permite ajustar los límites de atención y los límites de seguridad.

Permite controlar el proceso de soldadura ajustando en los principales parámetros mensurables límites de atención y límites de seguridad.

Permite un control preciso de las distintas fases de soldadura.

5.2 Procedimientos específicos de uso de los parámetros

5.2.1 Personalizar pantalla 7 segmentos

Permite visualizar constantemente el valor de un parámetro en la pantalla de 7 segmentos.

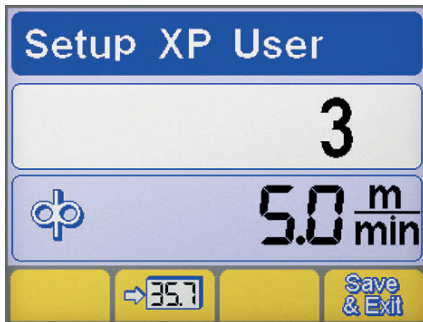

- ▶ Entre en la configuración pulsando la tecla encoder durante al menos 5 segundos.
- ▶ Seleccione el parámetro deseado girando el encoder.
- ▶ Memorice el parámetro seleccionado en la pantalla de 7 segmentos pulsando la tecla .
- ▶ Guarde y salga de la pantalla actual pulsando la tecla .

ES

5.2.2 Personalizar el interfaz (Set up 500)

Permite personalizar los parámetros en la pantalla principal.

500 Configuración de la máquina

Permite seleccionar el interface gráfico deseado.

Valeur	Interfaz Usuario
XE	Modo Easy
XA	Modo Advanced
XP	Modo Professional

MODALIDAD XE

MMA	
Parámetros de soldadura	
TIG	
Parámetros de soldadura	
Funciones	

MODALIDAD XA

MMA	
Parámetros de soldadura	
Funciones	
TIG	
Parámetros de soldadura	
Funciones	

MODALIDAD XP

MMA	
Parámetros de soldadura	
Funciones	
TIG	
Parámetros de soldadura	
Funciones	

5.2.3 Lock/unlock (Set up 551)

Permite bloquear los comandos del panel e introducir un código de protección.

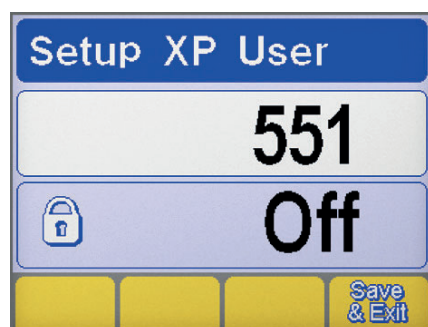

Selección parámetro

- ▶ Entre en la configuración pulsando la tecla encoder durante al menos 5 segundos.
- ▶ Seleccione el parámetro deseado (551).
- ▶ Active la regulación del parámetro seleccionado pulsando la tecla encoder.

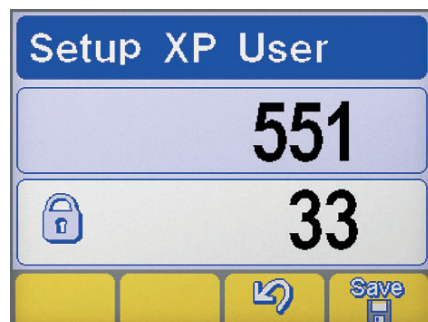

Configuración contraseña

- ▶ Ajuste una codificación numérica (contraseña) girando el encoder.
- ▶ Confirme la operación pulsando el botón encoder.
- ▶ Anule la operación pulsando la tecla .
- ▶ Para guardar la modificación, pulse el botón: .

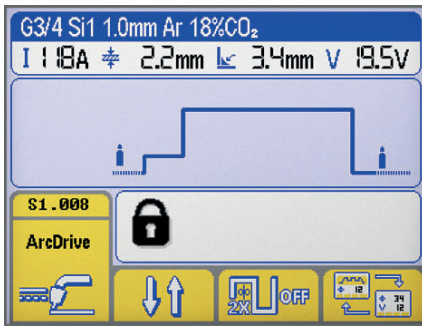

Funciones del panel



Al ejecutar cualquier operación en un panel de comandos bloqueado, aparecerá una pantalla especial.

- ▶ Acceda temporalmente (5 minutos) a las funciones del panel girando el encoder e introduciendo el código numérico correcto.
- ▶ Confirme la operación pulsando el botón encoder.
- ▶ Puede desbloquear definitivamente el panel de comandos entrando en la configuración (siga las indicaciones descritas anteriormente) y reajustando el parámetro 551 a "off".
- ▶ Confirme la operación pulsando el botón encoder.
- ▶ Para guardar la modificación, pulse el botón: .

5.2.4 Gestión de comandos externos (Set up 602)

Permite la gestión del parámetro externo 2 (valor mínimo, valor máximo, valor por defecto, parámetro seleccionado).

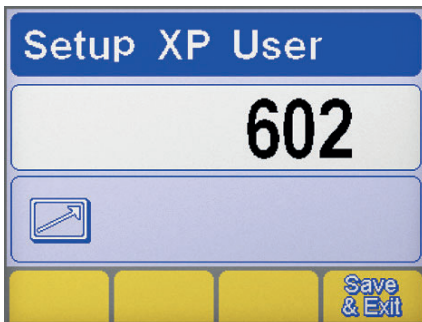

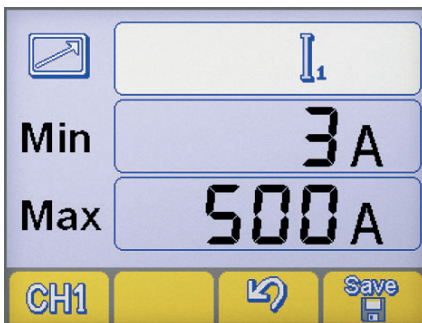

Selección parámetro

- ▶ Entre en la configuración pulsando la tecla encoder durante al menos 5 segundos.
- ▶ Seleccione el parámetro deseado (602).
- ▶ Entre en la pantalla "Gestión de comandos externos" pulsando la tecla encoder.



Gestión de comandos externos

- ▶ Seleccione la salida de control RC deseada (CH1, CH2, CH3, CH4) pulsando la tecla. 
- ▶ Seleccione el parámetro deseado (Mín.-Máx.-parámetro) pulsando la tecla encoder.
- ▶ Regule el parámetro deseado (Mín.-Máx.-parámetro) girando el encoder.
- ▶ Para guardar la modificación, pulse el botón: .
- ▶ Anule la operación pulsando la tecla .

5.2.5 Ajuste resistencia del circuito (set up 705)

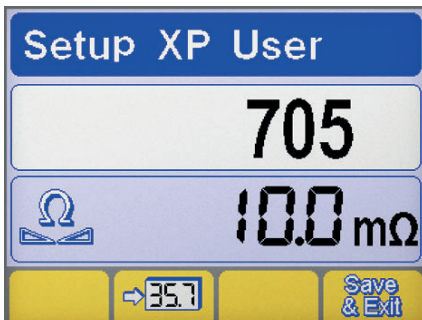



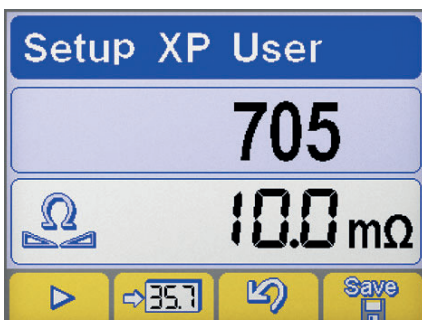

Selección parámetro

- ▶ Entre en la configuración pulsando la tecla encoder durante al menos 5 segundos.
- ▶ Seleccione el parámetro deseado (705).
- ▶ Active la regulación del parámetro seleccionado pulsando la tecla encoder.



Pantalla de "INFO"

- ▶ Ponga en contacto eléctrico el electrodo de tungsteno y la pieza a soldar. (TIG)
- ▶ Poner en contacto la antorcha portaelectrodos y la pieza a soldar. (MMA)
- ▶ Pulse el botón  (o el botón de la antorcha) para iniciar el procedimiento.
- ▶ Mantenga el contacto durante al menos un segundo.
- ▶ El valor que se visualiza en la pantalla se actualizará cuando se complete el ajuste.
- ▶ Anule la operación pulsando la tecla .
- ▶ Anule la operación pulsando la tecla .
- ▶ Para guardar la modificación y salir de la configuración, pulse el botón: .

5.2.6 Límites de seguridad (Set up 801)

Permite ajustar los límites de atención y los límites de seguridad.

Permite controlar el proceso de soldadura ajustando en los principales parámetros mensurables límites de atención y límites de seguridad.

Permite un control preciso de las distintas fases de soldadura.

Consulte la sección "Límites de seguridad (Set up 801)".

Límites de atención	<input type="button" value="MIN"/> <input type="button" value="MAX"/>	Límites de seguridad	<input type="button" value="MIN"/> <input type="button" value="MAX"/>
---------------------	---	----------------------	---

- | | |
|--|--|
| <ul style="list-style-type: none"> Corriente de soldadura Lectura de capacidad del gas Lectura de corriente (motor 1) Lectura del flujo del líquido refrigerante Lectura de temperatura del líquido refrigerante | <ul style="list-style-type: none"> Tensión de soldadura Velocidad de desplazamiento del robot Lectura de corriente (motor 2) Lectura de la velocidad del alambre |
|--|--|

ES

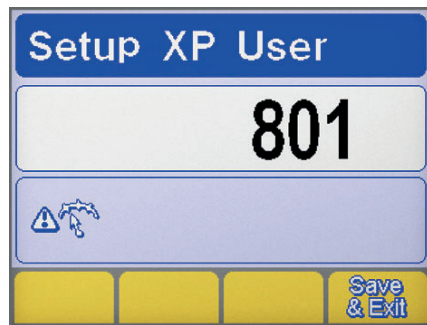

Selección parámetro

- ▶ Entre en la configuración pulsando la tecla encoder durante al menos 5 segundos.
- ▶ Seleccione el parámetro deseado (801).
- ▶ Entre en la pantalla "Límites de seguridad" pulsando la tecla encoder.

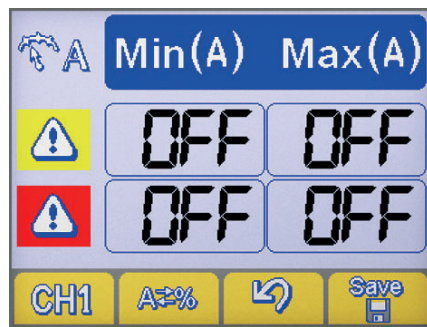

Selección del parámetro

- ▶ Seleccione el parámetro deseado pulsando la tecla **CH1**.
- ▶ Seleccione el modo de ajuste de los límites de seguridad pulsando la tecla **A=%**.

Configuración de la máquina

Valor absoluto

Valor porcentual

Configuración límites de protección

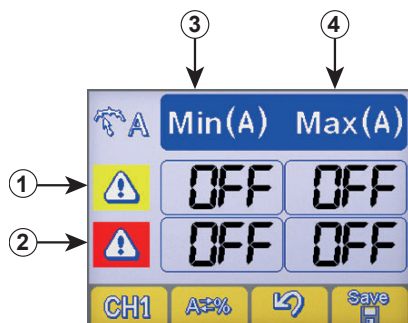

- ① Línea de los límites de atención
- ② Línea de los límites de alarma
- ③ Columna de los niveles mínimos
- ④ Columna de los niveles máximos

- ▶ Seleccione la casilla deseada pulsando la tecla encoder (la casilla seleccionada se visualiza con contraste invertido).
- ▶ Regule el nivel del límite seleccionado girando el encoder.
- ▶ Para guardar la modificación, pulse el botón: .



Si supera uno de los límites de atención, se visualizará una señal en el panel de comandos.



Si supera uno de los límites de alarma, se visualizará una señal en el panel de comandos y se bloquearán inmediatamente las operaciones de soldadura.



Es posible ajustar los filtros de inicio y finalización de la soldadura para evitar señales de error en las fases de inicio y fin del arco (consulte la sección "Configuración" - Parámetros 802-803-804).

6. MANTENIMIENTO



Efectúe el mantenimiento ordinario del equipo según las indicaciones del fabricante. Cuando el equipo esté funcionando, todas las puertas de acceso y de servicio y las tapas tienen que estar cerradas y fijadas perfectamente. El equipo no debe ser modificado. Procure que no se forme polvo metálico en proximidad y cerca o encima de las aletas de ventilación.



El mantenimiento debe efectuarlo personal cualificado. La reparación o la sustitución de componentes del sistema por parte de personal no autorizado provoca la caducidad inmediata de la garantía del producto. La reparación o sustitución de componentes del equipo debe ser hecha realizarla personal técnico cualificado.



¡Antes de cada operación, desconecte el equipo!

6.1 Controles periódicos de la fuente de alimentación

6.1.1 Equipo



Limpie el interior con aire comprimido a baja presión y con pinceles de cerdas suaves. Compruebe las conexiones eléctricas y todos los cables de conexión.

6.1.2 Para el mantenimiento o la sustitución de los componentes de las antorchas, de la pinza portaelectrodo y/o de los cables de masa:



Controle la temperatura de los componentes y compruebe que no estén sobrecalentados.



Utilice siempre guantes conformes a las normativas.



Use llaves y herramientas adecuadas.

6.2 Responsabilidad



La carencia de este mantenimiento, provocará la caducidad de todas las garantías y el fabricante se considerará exento de toda responsabilidad. Si el operador no respetara las instrucciones descritas, el fabricante declina cualquier responsabilidad. Si tuviera dudas y/o problemas no dude en consultar al centro de asistencia técnica más cercano.

7. CODIFICACIÓN DE ALARMAS



ALARMA

La activación de una alarma o la superación de un límite de seguridad crítico provoca una señal visual en el panel de mandos y el bloqueo inmediato de las operaciones de soldadura.



ATENCIÓN

Si se supera un límite de protección, se activa una señal visual en el panel de mandos, pero es posible continuar con las operaciones de soldadura.

A continuación se enumeran todas las alarmas y todos los límites de protección relativos al sistema.

E01	Exceso de temperatura		E02	Exceso de temperatura	
E03	Exceso de temperatura		E05	Sobrecorriente	
E06	Sobrecorriente módulo de potencia (Boost)		E07	Fallo del sistema de alimentación del motor del alimentador de alambre	
E08	Motor bloqueado		E10	Sobrecorriente módulo de potencia (Inverter)	
E11	Error de configuración del sistema		E13	Error de comunicación (FP)	
E14.xx	Programa no válido el subcódigo del error indica el número del trabajo eliminado		E15	Programa no válido	
E16	Error de comunicación (RI) (Automatización y robótica)		E18.xx	Programa no válido el subcódigo del error indica el número del trabajo eliminado	
E19	Error de configuración del sistema		E20	Memoria averiada	
E21	Pérdida de datos		E22	Error de comunicación (DSP)	
E27	Memoria averiada (RTC)		E29	Medidas incompatibles	
E30	Error de comunicación (H.F.)		E32	Pérdida de datos	
E33	Error de configuración del sistema (LCD 3.5")		E38	Subtensión	
E39	Fallo alimentación del equipo		E40	Fallo alimentación del equipo	
E41	Sobretensión		E42	Subtensión	

 E43	Falta líquido refrigerante		 E49	Interruptor de emergencia (Automatización y robótica)	
 E51	Configuraciones no admitidas (Automatización y robótica)		 E52	Anticolisión (Automatización y robótica)	
 E53	Error interruptor de flujo externo (Automatización y robótica)		 E54	Superado el nivel de corriente (Límite inferior)	
 E55	Superado el nivel de corriente (Límite superior)		 E56	Superado el nivel de tensión (Límite inferior)	
 E57	Superado el nivel de tensión (Límite superior)		 E58	Superado el nivel de flujo de gas (Límite inferior)	
 E59	Superado el nivel de flujo de gas (Límite superior)		 E62	Superado el nivel de corriente (Límite inferior)	
 E63	Superado el nivel de corriente (Límite superior)		 E64	Superado el nivel de tensión (Límite inferior)	
 E65	Superado el nivel de tensión (Límite superior)		 E66	Superado el nivel de flujo de gas (Límite inferior)	
 E67	Superado el nivel de flujo de gas (Límite superior)		 E71	Sobretensión líquido refrigerante	
 E72	Sobrecorriente motor push-pull		 E73	Superado el límite de velocidad del alambre (speed meter)	
 E75	Superado el nivel de corriente motor 2		 E76	Superado el nivel de flujo líquido refrigerante	
 E77	Nivel de temperatura líquido refrigerante		 E78	Mantenimiento activo (Automatización y robótica)	
 E81	Sobrecorriente (bomba WU)		 E82	Error de comunicación (WU)	
 E83	Bomba bloqueada		 E99	Alarma general	

8. DIAGNÓSTICO Y SOLUCIÓN DE PROBLEMAS

El sistema no se activa (led verde apagado)

Causa	Solución
» No hay tensión de red en la toma de alimentación.	» Compruebe y repare la instalación eléctrica. » Consulte con personal experto.
» Enchufe o cable de alimentación averiado.	» Sustituya el componente averiado. » Contacte con el centro de asistencia más cercano para la reparación del sistema.
» Fusible de línea quemado.	» Sustituya el componente averiado.
» Conmutador de alimentación averiado.	» Sustituya el componente averiado. » Contacte con el centro de asistencia más cercano para la reparación del sistema.
» Electrónica averiada.	» Contacte con el centro de asistencia más cercano para la reparación del sistema.

Falta de potencia de salida (el sistema no suelda)

Causa	Solución
» Botón de la antorcha averiado.	» Sustituya el componente averiado. » Contacte con el centro de asistencia más cercano para la reparación del sistema.
» Equipo sobrecalentado (alarma de temperatura - led amarillo iluminado).	» Espere a que se enfríe el sistema desactivarlo.
» Conexión de masa incorrecta.	» Conecte correctamente la masa. » Consulte el párrafo "Instalación".
» Tensión de red fuera de rango (led amarillo iluminado).	» Restablezca la tensión de red dentro del campo de la fuente de alimentación. » Conecte correctamente el equipo. » Consulte el párrafo "Conexiones".
» Telerruptor averiado.	» Sustituya el componente averiado. » Contacte con el centro de asistencia más cercano para la reparación del sistema.
» Electrónica averiada.	» Contacte con el centro de asistencia más cercano para la reparación del sistema.

Suministro de potencia incorrecto

Causa	Solución
» Selección incorrecta del proceso de soldadura o selector averiado.	» Seleccione correctamente el proceso de soldadura.
» Configuraciones incorrectas de los parámetros y de las funciones de la instalación.	» Reinicie el sistema y vuelva a configurar los parámetros de soldadura.
» Potenciómetro/encoder para el ajuste de la corriente de soldadura averiado.	» Sustituya el componente averiado. » Contacte con el centro de asistencia más cercano para la reparación del sistema.
» Tensión de red fuera de rango.	» Conecte correctamente el equipo. » Consulte el párrafo "Conexiones".
» Falta una fase.	» Conecte correctamente el equipo. » Consulte el párrafo "Conexiones".
» Electrónica averiada.	» Contacte con el centro de asistencia más cercano para la reparación del sistema.

Inestabilidad del arco

Causa	Solución
» Protección de gas insuficiente.	» Ajuste el flujo de gas. » Compruebe que el difusor y la boquilla de gas de la antorcha estén en buenas condiciones.

» Presencia de humedad en el gas de soldadura.	» Utilice siempre productos y materiales de calidad.
	» Mantenga en perfectas condiciones el sistema de suministro del gas.
» Parámetros de soldadura incorrectos.	» Compruebe cuidadosamente el sistema de soldadura.
	» Contacte con el centro de asistencia más cercano para la reparación del sistema.

Proyecciones excesivas de salpicaduras

Causa	Solución
» Longitud de arco incorrecta.	» Reduzca la distancia entre electrodo y pieza.
	» Reduzca la tensión de soldadura.
» Parámetros de soldadura incorrectos.	» Reduzca la tensión de soldadura.
» Protección de gas insuficiente.	» Ajuste el flujo de gas.
	» Compruebe que el difusor y la boquilla de gas de la antorcha estén en buenas condiciones.
» Dinámica de arco incorrecta.	» Aumente el valor inductivo del circuito.
» Modo de soldadura incorrecto.	» Reduzca la inclinación de la antorcha.

Insuficiente penetración

Causa	Solución
» Modo de soldadura incorrecto.	» Reduzca la velocidad de avance durante la soldadura.
» Parámetros de soldadura incorrectos.	» Aumente la corriente de soldadura.
» Electrodo inadecuado.	» Utilice un electrodo de diámetro más pequeño.
» Preparación incorrecta de los bordes.	» Aumente la apertura del achaflanado.
» Conexión de masa incorrecta.	» Conecte correctamente la masa.
	» Consulte el párrafo "Instalación".
» Las piezas a soldar son demasiado grandes.	» Aumente la corriente de soldadura.

Inclusiones de escoria

Causa	Solución
» Limpieza incompleta.	» Limpie perfectamente las piezas antes de la soldadura.
» Electrodo de diámetro muy grueso.	» Utilice un electrodo de diámetro más pequeño.
» Preparación incorrecta de los bordes.	» Aumente la apertura del achaflanado.
» Modo de soldadura incorrecto.	» Reduzca la distancia entre electrodo y pieza.
	» Avance regularmente durante la soldadura.

Inclusiones de tungsteno

Causa	Solución
» Parámetros de soldadura incorrectos.	» Reduzca la tensión de soldadura.
	» Utilice un electrodo de diámetro superior.
» Electrodo inadecuado.	» Utilice siempre productos y materiales de calidad.
	» Afile correctamente el electrodo.
» Modo de soldadura incorrecto.	» Evite los contactos entre electrodo y soldadura de inserción.

Sopladuras

Causa	Solución
» Protección de gas insuficiente.	» Ajuste el flujo de gas.
	» Compruebe que el difusor y la boquilla de gas de la antorcha estén en buenas condiciones.

Encoladura

Causa	Solución
» Longitud de arco incorrecta.	» Aumente la distancia entre electrodo y pieza.
	» Aumente la tensión de soldadura.

» Parámetros de soldadura incorrectos.

» Aumente la corriente de soldadura.

» Aumente la tensión de soldadura.

» Modo de soldadura incorrecto.

» Aumente el ángulo de inclinación de la antorcha.

» Las piezas a soldar son demasiado grandes.

» Aumente la corriente de soldadura.

» Aumente la tensión de soldadura.

» Dinámica de arco incorrecta.

» Aumente el valor inductivo del circuito.

Incisiones marginales

Causa

» Parámetros de soldadura incorrectos.

Solución

» Reduzca la tensión de soldadura.

» Utilice un electrodo de diámetro más pequeño.

» Longitud de arco incorrecta.

» Reduzca la distancia entre electrodo y pieza.

» Reduzca la tensión de soldadura.

» Modo de soldadura incorrecto.

» Reduzca la velocidad de oscilación lateral en el llenado.

» Reduzca la velocidad de avance durante la soldadura.

» Protección de gas insuficiente.

» Utilice gases adecuados para los materiales a soldar.

Oxidaciones

Causa

» Protección de gas insuficiente.

Solución

» Ajuste el flujo de gas.

» Compruebe que el difusor y la boquilla de gas de la antorcha estén en buenas condiciones.

Porosidades

Causa

» Presencia de grasa, pintura, óxido o suciedad en las piezas a soldar.

Solución

» Limpie perfectamente las piezas antes de la soldadura.

» Presencia de grasa, pintura, óxido o suciedad en el material de aportación.

» Utilice siempre productos y materiales de calidad.

» Mantenga siempre en perfectas condiciones el material de aportación.

» Presencia de humedad en el material de aportación.

» Utilice siempre productos y materiales de calidad.

» Mantenga siempre en perfectas condiciones el material de aportación.

» Longitud de arco incorrecta.

» Reduzca la distancia entre electrodo y pieza.

» Reduzca la tensión de soldadura.

» Presencia de humedad en el gas de soldadura.

» Utilice siempre productos y materiales de calidad.

» Mantenga en perfectas condiciones el sistema de suministro del gas.

» Protección de gas insuficiente.

» Ajuste el flujo de gas.

» Compruebe que el difusor y la boquilla de gas de la antorcha estén en buenas condiciones.

» Solidificación muy rápida de la soldadura de inserción.

» Reduzca la velocidad de avance durante la soldadura.

» Precaliente las piezas a soldar.

» Aumente la corriente de soldadura.

Grietas en caliente

Causa

» Parámetros de soldadura incorrectos.

Solución

» Reduzca la tensión de soldadura.

» Utilice un electrodo de diámetro más pequeño.

» Presencia de grasa, pintura, óxido o suciedad en las piezas a soldar.

» Limpie perfectamente las piezas antes de la soldadura.

» Presencia de grasa, pintura, óxido o suciedad en el material de aportación.

» Utilice siempre productos y materiales de calidad.

» Mantenga siempre en perfectas condiciones el material de aportación.

» Modo de soldadura incorrecto.

» Siga las secuencias operativas correctas para el tipo de unión a soldar.

» Piezas a soldar con características diferentes.

» Aplique un depósito superficial preliminar antes de la soldadura.

Grietas en frío
Causa

» Presencia de humedad en el material de aportación.

» Forma especial de la unión a soldar.

Solución

» Utilice siempre productos y materiales de calidad.

» Mantenga siempre en perfectas condiciones el material de aportación.

» Precaliente las piezas a soldar.

» Haga un postcalentamiento.

» Siga las secuencias operativas correctas para el tipo de unión a soldar.

9. INSTRUCCIONES DE USO

9.1 Soldaduras con electrodo recubierto (MMA)

Preparación de los bordes

Para obtener buenas soldaduras es recomendable trabajar sobre piezas limpias, no oxidadas, sin herrumbre ni otros agentes contaminadores.

Elección del electrodo

El diámetro del electrodo que se ha de emplear depende del espesor del material, de la posición, del tipo de unión y del tipo de preparación de la pieza a soldar.

Los electrodos de mayor diámetro requieren corrientes muy elevadas y en consecuencia una mayor aportación térmica en la soldadura.

Tipo de revestimiento	Propiedades	Uso
Rútilo	Facilidad de uso	Todas las posiciones
Ácido	Alta velocidad de fusión	Plano
Básico	Alta calidad de la unión	Todas las posiciones

Elección de la corriente de soldadura

La gama de la corriente de soldadura relativa al tipo de electrodo utilizado está especificada por el fabricante en el mismo embalaje de los electrodos.

Encendido y mantenimiento del arco

El arco eléctrico se produce al frotar la punta del electrodo sobre la pieza a soldar conectada al cable de masa y, una vez encendido el arco, retirando rápidamente el electrodo hasta situarlo en la distancia de soldadura normal.

Para mejorar el encendido del arco es útil, en general, un incremento inicial de corriente respecto a la corriente base de soldadura (Hot Start).

Una vez que se ha producido el arco eléctrico, empieza la fusión de la parte central del electrodo que se deposita en forma de gotas en la pieza a soldar.

El revestimiento externo del electrodo se consume, suministrando así el gas de protección para la soldadura y garantizando su buena calidad.

Para evitar que las gotas de material fundido, apaguen el arco al provocar un cortocircuito y pegarse el electrodo al baño de soldadura, debido a su proximidad, se produce un aumento provisional de la corriente de soldadura para fundir el cortocircuito (Arc Force).

Si el electrodo quedara pegado a la pieza por a soldar es útil reducir al mínimo la corriente de cortocircuito (antisticking).

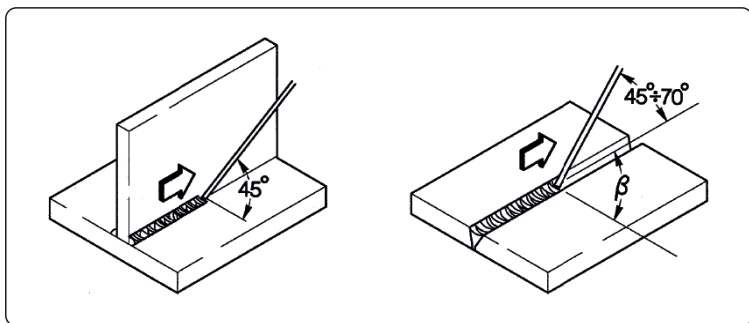
Ejecución de la soldadura

El ángulo de inclinación del electrodo cambia según el número de pasadas; el movimiento del electrodo se realiza normalmente con oscilaciones y paradas a los lados del cordón para evitar la excesiva acumulación del material de aportación en la parte central.

Retirar la escoria

La soldadura mediante electrodos recubiertos obliga a retirar la escoria tras cada pasada.

La limpieza se efectúa mediante un pequeño martillo o mediante cepillo en caso de escoria fría.

9.2 Soldadura TIG (arco continuo)

Descripción

El proceso de soldadura TIG (Tungsten Inert Gas) se basa en la presencia de un arco eléctrico que se forma entre un electrodo infusible (de tungsteno puro o en aleación, con una temperatura de fusión de aproximadamente 3370°C) y la pieza; una atmósfera de gas inerte (argón) asegura la protección del baño.

Para evitar inserciones peligrosas de tungsteno en la unión, el electrodo jamás tiene que entrar en contacto con la pieza a soldar; por ello, la fuente de alimentación de soldadura dispone normalmente de un dispositivo de encendido del arco que genera una descarga de alta frecuencia y alta tensión entre la punta del electrodo y la pieza a soldar. Así, gracias a la chispa eléctrica, al ionizarse la atmósfera del gas se enciende el arco de soldadura sin que haya contacto entre el electrodo y la pieza a soldar.

Existe también otro tipo de inicio, con menos inclusiones de tungsteno: el inicio en lift que no necesita alta frecuencia, sino sólo de una situación inicial de un cortocircuito de baja corriente entre el electrodo y la pieza; en el momento en que se levanta el electrodo se establece el arco, y la corriente aumenta hasta el valor de soldadura introducido.

Para mejorar la calidad de la parte final del cordón de soldadura es útil poder controlar con exactitud el descenso de la corriente de soldadura y es necesario que el gas fluya en el baño de soldadura durante unos segundos después de la extinción del arco.

En muchas condiciones de trabajo es útil poder disponer de 2 corrientes de soldadura programadas previamente y poder pasar fácilmente de una a otra (Bilevel).

Polaridad de soldadura

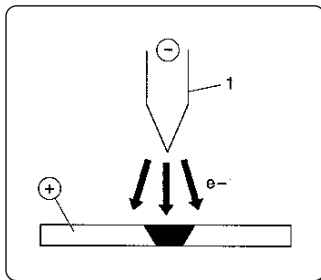

D.C.S.P. (Direct Current Straight Polarity)

Es la polaridad más utilizada (polaridad directa), permite un reducido desgaste del electrodo (1) puesto que el 70% del calor se concentra sobre el ánodo (es decir, sobre la pieza).

Se obtienen baños estrechos y hondos con elevada velocidad de avance y, en consecuencia, con baja aportación térmica.

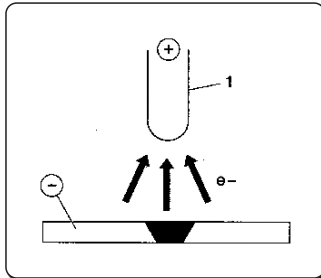

D.C.R.P. (Direct Current Reverse Polarity)

La polaridad invertida permite la soldadura de aleaciones recubiertas por una capa de óxido refractario con temperatura de fusión superior a la del metal.

No se pueden utilizar corrientes elevadas, puesto que éstas producirían un elevado desgaste del electrodo.

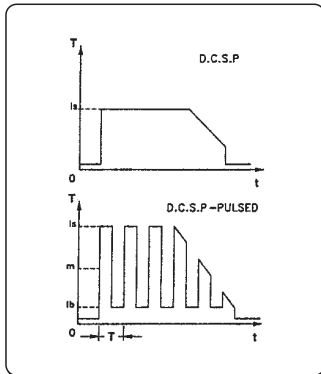

D.C.S.P.-Pulsed (Direct Current Straight Polarity Pulsed)

La utilización de una corriente directa intermitente permite un mejor control del baño de soldadura en determinadas condiciones de trabajo.

El baño de soldadura se forma por los impulsos de punta (Ip), mientras que la corriente de base (Ib) mantiene el arco encendido. Esta solución facilita la soldadura de pequeños espesores con menores deformaciones, un mejor factor de forma y consiguiente menor peligro de agrietamiento en caliente y de inclusiones gaseosas.

Al aumentar la frecuencia (media frecuencia) se obtiene un arco más estrecho, más concentrado y más estable y una ulterior mejora de la calidad de la soldadura de espesores delgados.

Características de las soldaduras TIG

El procedimiento TIG es muy eficaz en la soldadura de aceros, tanto al carbono como aleaciones, para la primera pasada sobre tubos y en las soldaduras que deben presentar un aspecto estético excelente.

Se requiere la polaridad directa (D.C.S.P.).

Preparación de los bordes

El procedimiento requiere una cuidadosa limpieza y preparación de los bordes.

Elección y preparación del electrodo

Se aconseja usar electrodos de tungsteno de torio (2% de torio-color rojo) o, como alternativa, electrodos de cerio o de lantano con los siguientes diámetros:

Gama de corriente			Electrodo	
(DC-)	(DC+)	(AC)	Ø	α
3-20 A	-	3-20 A	0,5 mm	30°
15-80 A	-	20-30 A	1,0 mm	30-60°
70-150 A	10-20 A	30-80 A	1,6 mm	60-90°
150-250 A	15-30 A	60-130 A	2,4 mm	90-120°
250-400 A	25-40 A	100-180 A	3,2 mm	120-150°
400-500 A	40-55 A	160-240 A	4,0 mm	150-180°
500-750 A	55-80 A	190-300 A	4,8 mm	150-180°
750-1100 A	80-125 A	325-450 A	6,4 mm	150-180°

El electrodo debe estar afilado de la forma mostrada en la figura.

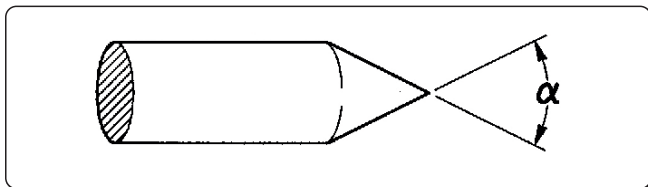

Material de aportación

Las varillas de aportación deben tener unas propiedades mecánicas similares a las del material de base.

No utilice trozos extraídos del material de base, puesto que pueden afectar negativamente a las soldaduras mismas.

Gas de protección

Prácticamente se utiliza siempre el argón puro (99.99%).

Gama de corriente			Gas	
(DC-)	(DC+)	(AC)	Boquilla	Flujo
3-20 A	-	3-20 A	n° 4	5-6 l/min
15-80 A	-	20-30 A	n° 5	6-8 l/min
70-150 A	10-20 A	30-80 A	n° 6	7-10 l/min
150-250 A	15-30 A	60-130 A	n° 7	8-12 l/min
250-400 A	25-40 A	100-180 A	n° 8	10-14 l/min
400-500 A	40-55 A	160-240 A	n° 8	12-16 l/min
500-750 A	55-80 A	190-300 A	n° 10	15-20 l/min
750-1100 A	80-125 A	325-450 A	n° 12	20-25 l/min

10. CARACTERÍSTICAS TÉCNICAS

Características eléctricas			U.M.
Tensión de alimentación U1 (50/60 Hz)	3x230 (±15%)	3x400 (±15%)	Vac
Zmax (@PCC) *	53	53	mΩ
Fusible de línea retardado	25	16	A
Tipo de comunicación	DIGITAL	DIGITAL	
Potencia máxima absorbida	10.5	10.5	kVA
Potencia máxima absorbida	10.1	10.1	kW
Potencia absorbida en estado inactivo	51	51	W
Factor de potencia (PF)	0.96	0.96	
Rendimiento (μ)	83	83	%
Cos φ	0.99	0.99	
Corriente máxima absorbida I1max	30.8	15.3	A
Corriente efectiva I1eff	18	9	A
Gama de ajuste	3-270	3-270	A
Tensión en vacío Uo	80	80	Vdc
Tensión de pico Up	10.1	10.1	kV

* Este dispositivo cumple con los requisitos de la Normativa EN / IEC 61000-3-11.

* Este dispositivo cumple con los requisitos de la normativa EN / IEC 61000-3-12, si la máxima impedancia de red admitida en el punto de interacción con la red pública (punto de acoplamiento común - "point of common coupling", PCC) es inferior o igual al valor "Zmax" declarado. Si el dispositivo se conecta a la red pública de baja tensión, es responsabilidad del instalador o del usuario, consultando eventualmente al gestor de la red si es necesario, asegurarse de que el dispositivo se puede conectar.

Ciclo de trabajo	3x230V	3x400V	U.M.
Ciclo de trabajo (40°C)			
(X=35%)	270	270	A
(X=60%)	230	230	A
(X=100%)	180	180	A
Ciclo de trabajo (25°C)			
(X=80%)	270	270	A
(X=100%)	240	240	A

Características físicas			U.M.
Grado de protección IP	IP23S		
Clase de aislamiento	H		
Dimensiones (lxwxh)	500x190x400		mm
Peso	18.8		Kg
Sección cable de alimentación	4x4		mm ²
Longitud de cable de alimentación	5		m
Normas de fabricación	EN IEC 60974-1/A1:2019 EN IEC 60974-3:2019 EN 60974-10/A1:2015		

11. PLACA DE DATOS

 VOESTALPINE BÖHLER WELDING SELCO S.R.L. Via Palladio,19 - ONARA (PADOVA) - ITALY					
URANOS NX 2700 TLH			N°		
		EN 60974-1/A1:2019 60974-3:2019 IEC 60974-10/A1:2015 Class A			
Up 10.1 kV					
3A/10.0V - 270A (270A)/20.8V (20.8V)					
X (40°C) 35% 60% 100%					
S	U ₀ 80V	I _z	270A (270A)	230A (230A)	180A (180A)
		U _z	20.8V (20.8V)	19.2V (19.2V)	17.2V (17.2V)
3A/20.0V - 270A (270A)/30.8V (30.8V)					
X (40°C) 35% 60% 100%					
S	U ₀ 80V	I _z	270A (270A)	230A (230A)	180A (180A)
		U _z	30.8V (30.8V)	29.2V (29.2V)	27.2V (27.2V)
 50/60 Hz		U ₁ 400V(230V)	I _{1max} 15.3A(30.8A)	I _{1eff} 9A(18A)	
IP 23 S				 MADE IN ITALY	

ES

12. SIGNIFICADO DE LA ETIQUETA DE LOS DATOS

1		2			
3		4			
5		6			
7	9	23			
		11			
8	10	12	15	16	17
		13	15A	16A	17A
		14	15B	16B	17B
7	9	11			
		12	15	16	17
8	10	13	15A	16A	17A
		14	15B	16B	17B
		18	19	20	21
22		 MADE IN ITALY			

- 1 Marca de fabricación
- 2 Nombre y dirección del fabricante
- 3 Modelo del aparato
- 4 N° de serie
- XXXXXXXXXXX Año de fabricación
- 5 Símbolo del tipo de la unidad de soldadura
- 6 Referencia a las normas de construcción
- 7 Símbolo del proceso de soldadura
- 8 Símbolo por las soldadoras para los equipos adecuados para trabajar en un entorno con riesgo elevado de descarga eléctrica
- 9 Símbolo de la corriente de soldadura
- 10 Tensión asignada a vacío
- 11 Gama de la corriente máxima y mínima, y de la correspondiente tensión convencional de carga
- 12 Símbolo del ciclo de intermitencia
- 13 Símbolo de la corriente asignada de soldadura
- 14 Símbolo de la tensión asignada de soldadura
- 15 Valores del ciclo de intermitencia
- 16 Valores del ciclo de intermitencia
- 17 Valores del ciclo de intermitencia
- 15A Valores de la corriente asignada de soldadura
- 16A Valores de la corriente asignada de soldadura
- 17A Valores de la corriente asignada de soldadura
- 15B Valores de la tensión convencional de carga
- 16B Valores de la tensión convencional de carga
- 17B Valores de la tensión convencional de carga
- 18 Símbolo de la alimentación
- 19 Tensión asignada de alimentación
- 20 Máxima corriente asignada de alimentación
- 21 Máxima corriente efectiva de alimentación
- 22 Grado de protección
- 23 Tensión nominal de pico

CE Declaración UE de conformidad
 EAC Declaración de conformidad EAC
 UKCA Declaración de conformidad UKCA

DECLARAÇÃO DE CONFORMIDADE CE

O construtor

voestalpine Böhler Welding Selco S.r.l. - Via Palladio, 19 - 35019 Onara di Tombolo (PD) - ITALY
Tel. +39 049 9413/111 - Fax +39 049 9413/311 - www.voestalpine.com/welding

declara sob sua exclusiva responsabilidade que o seguinte produto:

URANOS NX 2700 TLH 55.07.042
55.07.043

está conforme as directivas UE:

2014/35/UE LOW VOLTAGE DIRECTIVE

2014/30/UE EMC DIRECTIVE

2011/65/UE RoHS DIRECTIVE

2019/1784/EU EcoDesign

2009/125/EU EcoDesign

e que as seguintes normas harmonizadas foram aplicadas:

EN IEC 60974-1/A1:2019 WELDING POWER SOURCE
EN IEC 60974-3:2019 ARC STRIKING AND STABILIZING DEVICES
EN 60974-10/A1:2015 ELECTROMAGNETIC COMPATIBILITY REQUIREMENTS

A documentação que atesta o cumprimento das diretrizes ficará à disposição para vistorias no referido fabricante.

Qualquer operação ou modificação não autorizada, previamente, pela voestalpine Böhler Welding Selco S.r.l. anulará a validade desta declaração.

Onara di Tombolo, 01/07/2024

voestalpine Böhler Welding Selco s.r.l.

Mirco Frasson Ivo Bonello

Managing Directors

ÍNDICE GERAL

1. ATENÇÃO	188
1.1 Condições de utilização	188
1.2 Protecção do operador e de outros indivíduos	188
1.3 Protecção contra fumos e gases	189
1.4 Prevenção contra incêndios/explosões	190
1.5 Precauções na utilização das botijas de gás	190
1.6 Protecção contra choques eléctricos.....	190
1.7 Campos electromagnéticos e interferências	190
1.8 Grau de protecção IP	192
1.9 Descarte	192
2. INSTALAÇÃO.....	192
2.1 Elevação, transporte e descarga	192
2.2 Posicionamento do equipamento.....	192
2.3 Ligações.....	192
2.4 Instalação.....	193
3. APRESENTAÇÃO DO SISTEMA	194
3.1 Painel traseiro	194
3.2 Painel de tomadas.....	195
3.3 Painel de comandos frontal.....	195
4. UTILIZAÇÃO DO EQUIPAMENTO	196
4.1 Ecrã inicial.....	196
4.2 Ecrã principal.....	196
4.3 Ecrã principal do processo MMA	197
5. DEFINIÇÕES.....	201
5.1 Definições e definição dos parâmetros	201
5.2 Procedimentos específicos de utilização dos parâmetros	207
6. MANUTENÇÃO.....	211
6.1 Efectuar periodicamente as seguintes operações.....	211
6.2 Ansvr	212
7. CÓDIGOS DE ALARME.....	212
8. RESOLUÇÃO DE PROBLEMAS.....	214
9. INSTRUÇÕES OPERACIONAIS	217
9.1 Soldadura manual por arco voltaico (MMA)	217
9.2 Soldadura TIG (arco contínuo).....	218
10. CARACTERÍSTICAS TÉCNICAS.....	220
11. PLACA DE DADOS.....	221
12. SIGNIFICADO DA PLACA DE DADOS	221
13. DIAGRAMA	438
14. CONECTORES.....	440
15. LISTA DE PEÇAS DE REPOSIÇÃO	441

SIMBOLOS



Atenção



Proibições



Obrigações



Indicações gerais

1. ATENÇÃO



Antes de iniciar qualquer tipo de operação na máquina, é necessário ler cuidadosamente e compreender o conteúdo deste manual.

Não efectuar modificações ou operações de manutenção que não estejam previstas. O fabricante não se responsabiliza por danos causados em pessoas ou bens, resultantes da utilização incorrecta ou da não-aplicação do conteúdo deste manual.

Manter sempre as instruções de utilização no local de utilização do aparelho. Para além das instruções de utilização, observar as normas gerais e os regulamentos locais de prevenção de acidentes e protecção ambiental em vigor.

A voestalpine Böhler Welding Selco S.r.l. tem o direito de modificar o conteúdo deste manual em qualquer altura, sem aviso prévio.

São reservados todos os direitos de tradução, reprodução e adaptação parcial ou total, seja por que meio for (incluindo fotocópia, filme e microfilme) e é proibida a reprodução sem autorização prévia, por escrito, da voestalpine Böhler Welding Selco S.r.l.

O exposto neste manual é de importância vital e, portanto, necessário para assegurar as garantias.

Caso o operador não respeite o prescrito, o fabricante declina toda e qualquer responsabilidade.



Todas as pessoas envolvidas na colocação em serviço, utilização, manutenção e reparação do aparelho devem:

- ser titulares de qualificação apropriada
- dispor das competências de soldadura necessárias
- ler integralmente e respeitar rigorosamente estas instruções de utilização

Para quaisquer dúvidas ou problemas relativos à utilização do equipamento, ainda que não se encontrem aqui descritos, consultar pessoal qualificado.

1.1 Condições de utilização



Cada instalação deve ser utilizada exclusivamente para as operações para que foi projectada, nos modos e nos âmbitos previstos na chapa de características e/ou neste manual, de acordo com as directivas nacionais e internacionais relativas à segurança. Uma utilização diferente da expressamente declarada pelo construtor deve ser considerada completamente inadequada e perigosa e, neste caso, o construtor declina toda e qualquer responsabilidade.



Esta máquina só deve ser utilizada com fins profissionais, numa instalação industrial. O construtor declina qualquer responsabilidade por eventuais danos provocados pela utilização da instalação em ambientes domésticos.



O equipamento deve ser utilizado em ambientes cujas temperaturas estejam compreendidas entre -10°C e +40°C (entre +14°F e +104°F).

O equipamento deve ser transportado e armazenado em ambientes cujas temperaturas estejam compreendidas entre -25°C e +55°C (entre -13°F e 131°F).

O equipamento deve ser utilizado em ambientes sem poeira, ácidos, gases ou outras substâncias corrosivas.

O equipamento deve ser utilizado em ambientes com humidade relativa não superior a 50%, a 40°C (104°F).

O equipamento deve ser utilizado em ambientes com humidade relativa não superior a 90%, a 20°C (68°F).

O equipamento deve ser utilizado a uma altitude máxima, acima do nível do mar, não superior a 2000 m (6500 pés).



Não utilizar o aparelho para descongelar tubos.

Não utilizar este equipamento para carregar baterias e/ou acumuladores.

Não utilizar este equipamento para fazer arrancar motores.

1.2 Protecção do operador e de outros indivíduos



O processo de soldadura é uma fonte nociva de radiações, ruído, calor e gases. Colocar um ecrã de protecção retardador de fogo, para proteger a área de soldadura de raios, faíscas e escórias incandescentes. Avisar todos os indivíduos nas proximidades que não devem olhar para o arco de soldadura ou metal incandescente e que devem utilizar protecção adequada.



Utilizar vestuário de protecção, para proteger a pele dos raios do arco, das faíscas ou do metal incandescente. O vestuário utilizado deve cobrir todo o corpo e deve:

- estar intacto e em bom Hóóestado
- ser à prova de fogo
- ser isolante e estar seco
- estar justo ao corpo e não ter dobras



Utilizar sempre calçado conforme às normas, resistentes e que garantam isolamento contra a água.



Utilizar sempre luvas conformes às normas, que garantam isolamento eléctrico e térmico.



Usar máscaras com protectores laterais da cara e filtros de protecção adequados para os olhos (pelo menos NR10 ou superior).



Utilizar sempre óculos de protecção, com protectores laterais, especialmente durante a remoção manual ou mecânica das escórias da soldadura.



Não utilizar lentes de contacto!



Utilizar protectores auriculares se, durante o processo de soldadura, forem atingidos níveis de ruído perigosos. Se o nível de ruído exceder os limites previstos pela lei, delimitar a área de trabalho e assegurar que todos os indivíduos que se encontram nas proximidades dispõem de protectores auriculares.



Durante as operações de soldadura, manter os painéis laterais sempre fechados. Os sistemas não devem ser submetidos a qualquer tipo de modificação.



Evitar tocar em peças acabadas de soldar, pois o elevado calor das mesmas pode causar queimaduras graves.



Respeitar todas as precauções descritas anteriormente também no que diz respeito a operações posteriores à soldadura pois podem desprender-se escórias das peças que estão a arrefecer.



Verificar se a tocha arrefeceu antes de executar trabalhos ou operações de manutenção.



Assegurar que o grupo de refrigeração é desactivado, antes de desligar os tubos de alimentação e retorno do líquido de refrigeração. O líquido quente em saída pode provocar queimaduras graves.



Manter perto de si um estojo de primeiros socorros, pronto a utilizar.
Não subestimar qualquer queimadura ou ferida.



Antes de abandonar o posto de trabalho, deixar a área de trabalho em boas condições de segurança, de maneira a evitar danos materiais e pessoais acidentais.

1.3 Protecção contra fumos e gases



Os fumos, gases e poeiras produzidos durante o processo de soldadura podem ser nocivos para a saúde.

Os fumos produzidos durante o processo de soldadura podem, em determinadas circunstâncias, provocar cancro ou danos no feto de mulheres grávidas.

- Manter a cabeça afastada dos gases e fumos de soldadura.
- Providenciar uma ventilação adequada, natural ou artificial, da zona de trabalho.
- Caso a ventilação seja inadequada, utilizar máscaras e dispositivos respiratórios.
- No caso da operação de soldadura ser efectuada numa área extremamente reduzida, o operador deverá ser observado por um colega, que deve manter-se no exterior durante todo o processo.
- Não utilizar oxigénio para a ventilação.
- Verificar a eficiência da exaustão comparando regularmente as quantidades de emissões de gases nocivos com os valores admitidos pelas normas de segurança.
- A quantidade e a periculosidade dos fumos produzidos está ligada ao material base utilizado, ao material de adição e às eventuais substâncias utilizadas para a limpeza e desengorduramento das peças a soldar. Seguir com atenção as indicações do construtor, bem como as instruções constantes das fichas técnicas.
- Não efectuar operações de soldadura perto de zonas de desengorduramento ou de pintura.
- Colocar as botijas de gás em espaços abertos ou em locais com boa ventilação.

1.4 Prevenção contra incêndios/explosões



O processo de soldadura pode provocar incêndios e/ou explosões.

- Retirar da área de trabalho e das áreas vizinhas todos os materiais ou objectos inflamáveis ou combustíveis.
- Os materiais inflamáveis devem estar a pelo menos 11 metros (35 pés) da área de soldadura ou devem estar adequadamente protegidos.
- A projecção de faíscas e de partículas incandescentes pode atingir, facilmente, as zonas circundantes, mesmo através de pequenas aberturas. Prestar especial atenção às condições de segurança de objectos e pessoas.
- Não efectuar operações de soldadura sobre ou perto de contentores sob pressão.
- Não efectuar operações de soldadura em contentores fechados ou tubos. Prestar especial atenção à soldadura de tubos ou recipientes, ainda que esses tenham sido abertos, esvaziados e cuidadosamente limpos. Resíduos de gás, combustível, óleo ou semelhantes poderiam causar explosões.
- Não efectuar operações de soldadura em locais onde haja poeiras, gases ou vapores explosivos.
- Verificar, no fim da soldadura, que o circuito sob tensão não pode entrar em contacto, acidentalmente, com partes ligadas ao circuito de terra.
- Colocar nas proximidades da área de trabalho um equipamento ou dispositivo de combate a incêndios.

1.5 Precauções na utilização das botijas de gás



As botijas de gás inerte contêm gás sob pressão e podem explodir se não estiverem garantidas as condições mínimas de segurança de transporte, de manutenção e de utilização.

- As botijas devem estar fixas verticalmente a paredes ou outros apoios, com meios adequados, para evitar quedas e choques mecânicos acidentais.
- Enroscar o capuz para a protecção da válvula, durante o transporte, a colocação em funcionamento e sempre que se concluem as operações de soldadura.
- Evitar a exposição das botijas aos raios solares, a mudanças bruscas de temperatura ou a temperaturas demasiado altas. Não expor as botijas a temperaturas demasiado altas ou baixas.
- Evitar que as botijas entrem em contacto com chamas livres, arcos eléctricos, tochas ou alicates porta-eléctrodos e materiais incandescentes projectados pela soldadura.
- Manter as botijas afastadas dos circuitos de soldadura e dos circuitos de corrente em geral.
- Ao abrir a válvula da botija, manter a cabeça afastada do ponto de saída do gás.
- Ao terminar as operações de soldadura, deve fechar-se sempre a válvula da botija.
- Nunca efectuar soldaduras sobre uma botija de gás sob pressão.
- Nunca ligar uma botija de ar comprimido directamente ao redutor de pressão da máquina! A pressão poderia superar a capacidade do redutor que consequentemente poderia explodir!

1.6 Protecção contra choques eléctricos



Um choque de descarga eléctrica pode ser mortal.

- Evitar tocar nas zonas normalmente sob tensão, no interior ou no exterior da máquina de soldar, enquanto a própria instalação estiver alimentada (tochas, pistolas, cabos de terra, fios, rolos e bobinas estão electricamente ligados ao circuito de soldadura).
- Efectuar o isolamento eléctrico da instalação e do operador, utilizando planos e bases secos e suficientemente isolados da terra.
- Assegurar-se de que o sistema está correctamente ligado a uma tomada e a uma fonte de alimentação equipada com condutor de terra.
- Não tocar simultaneamente em duas tochas ou em dois porta-eléctrodos.
- Se sentir um choque eléctrico, interrompa de imediato as operações de soldadura.



O dispositivo de escorvamento e estabilização do arco foi concebido para uma utilização manual ou mecânica.



Se o comprimento do maçarico ou dos cabos de soldadura for superior a 8 m, o risco de choque eléctrico é maior.

1.7 Campos electromagnéticos e interferências



A passagem da corrente, através dos cabos internos e externos da máquina, cria um campo electromagnético nas proximidades dos cabos de soldadura e do próprio equipamento.

- Os campos electromagnéticos podem ter efeitos (até hoje desconhecidos) sobre a saúde de quem está sujeito a exposição prolongada.

- Os campos electromagnéticos podem interferir com outros equipamentos tais como “pacemakers” ou aparelhos auditivos.



Os portadores de aparelhos electrónicos vitais (“pacemakers”) devem consultar o médico antes de procederem a operações de soldadura por arco.

1.7.1 Classificação CEM em conformidade com a norma: EN 60974-10/A1:2015.

Classe B

O equipamento Classe B cumpre os requisitos de compatibilidade electromagnética em ambientes industriais e residenciais, incluindo zonas residenciais em que o fornecimento de energia eléctrica é efectuado pela rede pública de baixa tensão.

Classe A

O equipamento Classe A não deve ser utilizado em zonas residenciais em que o fornecimento de energia eléctrica é efectuado pela rede pública de baixa tensão. Dado que eventuais perturbações de condutividade e radiação poderão dificultar a compatibilidade electromagnética do equipamento classe A nessas zonas.

Para mais informações, consulte o capítulo: PLACA DE DADOS ou Características técnicas.

1.7.2 Instalação, utilização e estudo da área

Este equipamento foi construído em conformidade com as indicações contidas na norma harmonizada EN 60974-10/A1:2015 e está identificado como pertencente à “CLASSE A”. Esta máquina só deve ser utilizada com fins profissionais, numa instalação industrial. O construtor declina qualquer responsabilidade por eventuais danos provocados pela utilização da instalação em ambientes domésticos.



O utilizador deve ser especializado na actividade, sendo, por isso, responsável pela instalação e pela utilização do equipamento de acordo com as indicações do fabricante. Caso se detectem perturbações electromagnéticas, o operador do equipamento terá de resolver o problema, se necessário em conjunto com a assistência técnica do fabricante.



As perturbações electromagnéticas têm sempre que ser reduzidas até deixarem de constituir um problema.



Antes de instalar este equipamento, o utilizador deverá avaliar potenciais problemas electromagnéticos que poderão ocorrer nas zonas circundantes e, particularmente, os relativos às condições de saúde das pessoas expostas, por exemplo, das pessoas que possuam “pacemakers” ou aparelhos auditivos.

1.7.3 Requisitos da rede de energia eléctrica

O equipamento de alta potência pode, em virtude da corrente primária distribuída pela rede de energia eléctrica, influenciar a qualidade da potência da rede. Por conseguinte, os requisitos ou restrições de ligação referentes à impedância da energia eléctrica máxima permitida (Z_{max}) ou à capacidade mínima de fornecimento (S_{sc}) exigida no ponto de ligação à rede pública (Ponto de Acoplamento Comum à rede pública (PAC)) podem aplicar-se a alguns tipos de equipamento (consultar os dados técnicos). Neste caso, compete ao instalador ou utilizador do equipamento garantir a ligação do equipamento, consultando o fornecedor da rede de distribuição, se necessário. Em caso de interferência, poderá ser necessário tomar precauções adicionais tais como a colocação de filtros na rede de alimentação.

É também necessário considerar a possibilidade de blindar o cabo de alimentação.

Para mais informações, consulte o capítulo: Características técnicas.

1.7.4 Precauções relacionadas com os cabos

Para minimizar os efeitos dos campos electromagnéticos, respeitar as seguintes instruções:

- Enrolar juntos e fixar, quando possível, o cabo de terra e o cabo de potência.
- Evitar enrolar os cabos à volta do corpo.
- Evitar colocar-se entre o cabo de terra e o cabo de potência (manter os dois cabos do mesmo lado).
- Os cabos deverão ser mantidos tão curtos quanto possível, colocados juntos entre si e mantidos ao nível do chão.
- Colocar o equipamento a uma certa distância da zona de soldadura.
- Os cabos devem ser colocados longe de outros cabos eventualmente presentes.

1.7.5 Ligação à terra

Deve ter-se em consideração que todos os componentes metálicos da instalação de soldadura e dos que se encontram nas suas proximidades devem ser ligados à terra. A ligação à terra deverá ser feita de acordo com as normas nacionais.

1.7.6 Ligação da peça de trabalho à terra

Quando a peça de trabalho não está ligada à terra, por razões de segurança eléctrica ou devido às suas dimensões e posição, uma ligação entre a peça e a terra poderá reduzir as emissões. É necessário ter em consideração que a ligação à terra da peça de trabalho não aumenta o risco de acidente para o operador nem danifica outros equipamentos eléctricos. A ligação à terra deverá ser feita de acordo com as normas nacionais.

1.7.7 Blindagem

A blindagem selectiva de outros cabos e equipamentos presentes na zona circundante pode reduzir os problemas provocados por interferência electromagnética.

A blindagem de toda a máquina de soldar pode ser ponderada para aplicações especiais.

1.8 Grau de protecção IP



IP23S

- Invólucro protegido contra o acesso de dedos a partes perigosas e contra objectos sólidos com diâmetro superior/ igual a 12,5 mm.
- Invólucro protegido contra chuva que caia num ângulo até 60°.
- Invólucro protegido contra os efeitos danosos devidos à entrada de água, quando as partes móveis do equipamento não estão em movimento.

1.9 Descarte



Não eliminar o equipamento elétrico juntamente com o lixo comum!

Em conformidade com a Diretiva Europeia 2012/19/UE relativa aos Resíduos de Equipamentos Elétricos e Eletrónicos e a sua aplicação de acordo com a legislação nacional, os equipamentos elétricos que tenham atingido o fim do seu ciclo de vida devem ser recolhidos separadamente e enviados para um centro de valorização e eliminação. Cabe ao proprietário do equipamento identificar os centros de recolha autorizados, solicitando informações às autoridades locais. A aplicação da Diretiva Europeia irá permitir melhorar o ambiente e a saúde humana.

» Para mais informações, consultar o site na internet.

2. INSTALAÇÃO



A instalação só pode ser executada por pessoal experiente e autorizado pelo fabricante.



Para executar a instalação, assegurar-se de que o gerador está desligado da rede de alimentação.



É proibida a ligação dos geradores em série ou em paralelo.

2.1 Elevação, transporte e descarga

- O equipamento é fornecido com uma pega, para transporte à mão.



Nunca subestimar o peso do equipamento, (ver características técnicas).

Nunca deslocar, ou posicionar, a carga suspensa sobre pessoas ou bens.

Não deixar cair o equipamento, nem exercer pressão desnecessária sobre ele.

2.2 Posicionamento do equipamento



Observar as seguintes regras:

- Fácil acesso aos comandos e ligações do equipamento.
- Não colocar o equipamento em espaços reduzidos.
- Nunca colocar o equipamento num plano com inclinação superior a 10° em relação ao plano horizontal.
- Ligar o equipamento num lugar seco, limpo e com ventilação apropriada.
- Proteger o equipamento da chuva e do sol.

2.3 Ligações



O equipamento dispõe de um cabo de alimentação para ligação à rede.

A instalação pode ser alimentada com:

- 230 V trifásico
- 400 V trifásico

O funcionamento do equipamento está garantido para tolerâncias de tensão variáveis entre $\pm 15\%$ do valor nominal.



Para evitar danos em pessoas ou no equipamento, é necessário controlar a tensão de rede seleccionada e os fusíveis ANTES de ligar a máquina à rede de alimentação. Além disso, é necessário assegurar-se de que o cabo é ligado a uma tomada que disponha de ligação à terra.



É possível alimentar a instalação por meio de um grupo electrogéneo, na condição deste garantir uma tensão de alimentação estável de $\pm 15\%$ relativamente ao valor de tensão nominal declarado pelo fabricante, em todas as condições de funcionamento possíveis e à máxima potência nominal. Normalmente, é aconselhável a utilização de grupos electrogéneos de potência nominal igual a 2 vezes a de uma fonte de alimentação monofásica ou de potência nominal igual a 1,5 vezes a de uma fonte de alimentação trifásica. É aconselhável o uso de grupos electrogéneos com controlo electrónico.



Para protecção dos utilizadores, o equipamento deve ser correctamente ligado à terra. O cabo de alimentação dispõe de um condutor (amarelo - verde) para ligação à terra, que deve ser ligado a uma ficha com ligação à terra. Este fio amarelo/verde NUNCA deve ser utilizado com outros condutores de corrente. Assegurar-se de que o local de instalação possui ligação à terra e de que as tomadas de corrente se encontram em perfeitas condições. Instalar somente fichas homologadas conformes às normas de segurança.



A instalação eléctrica deve ser executada por pessoal técnico especializado, com os requisitos técnico-profissionais específicos e em conformidade com a legislação do país em que se efectua a instalação.

2.4 Instalação

2.4.1 Ligação para a soldadura MMA



A ligação ilustrada na figura tem como resultado uma soldadura com polaridade inversa. Para obter uma soldadura com polaridade directa, inverta a ligação.

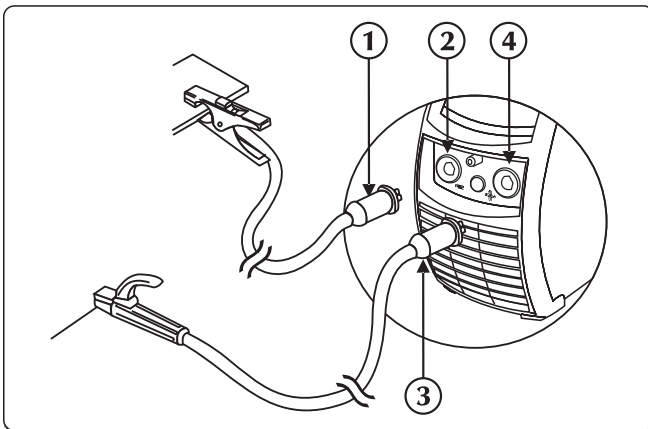

- ① Conector de pinça de ligação à terra
- ② Tomada negativa de potência (-)
- ③ Conector de pinça porta-eléctrodo
- ④ Tomada positiva de potência (+)

- ▶ Ligar o grampo de massa à tomada negativa (-) da fonte de alimentação. Inserir a ficha e rodar no sentido dos ponteiros do relógio até fixar.
- ▶ Ligar o porta-eléctrodo à tomada positiva (+) da fonte de alimentação. Inserir a ficha e rodar no sentido dos ponteiros do relógio até fixar.

2.4.2 Ligação para a soldadura TIG

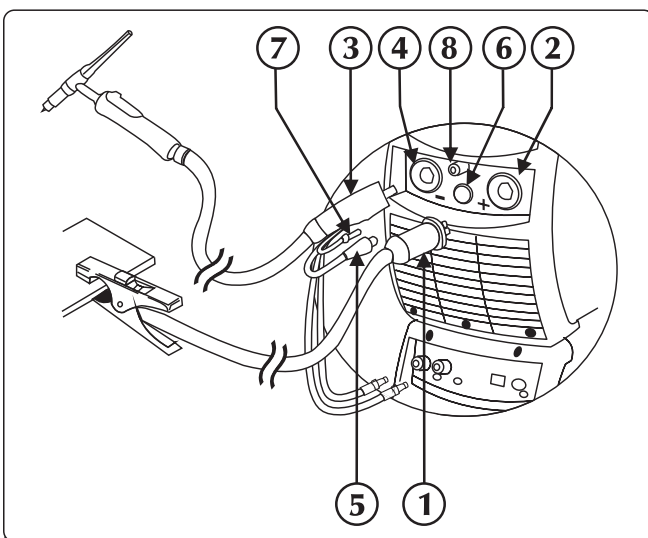

- ① Conector de pinça de ligação à terra
- ② Tomada positiva de potência (+)
- ③ Conexão da tocha TIG
- ④ Tomada da tocha
- ⑤ Cabo de sinal da tocha
- ⑥ Conectore
- ⑦ Tubo de gás de tocha
- ⑧ União/ligação de gás

- ▶ Ligar o grampo de massa à tomada positiva (+) da fonte de alimentação. Inserir a ficha e rodar no sentido dos ponteiros do relógio até fixar.

PT

- ▶ Ligar a tocha TIG à tomada da tocha da fonte de alimentação. Inserir a ficha e rodar no sentido dos ponteiros do relógio até fixar.
- ▶ Ligar o cabo de sinal da tocha à ligação adequada.
- ▶ Ligar o tubo de gás da tocha à união/ligação adequada.
- ▶ Ligar o tubo de água da tocha (vermelho) ao conector rápido de entrada da unidade (vermelho) de refrigeração.
- ▶ Ligar o tubo de água da tocha (azul escuro) ao conector rápido de saída da unidade de refrigeração.

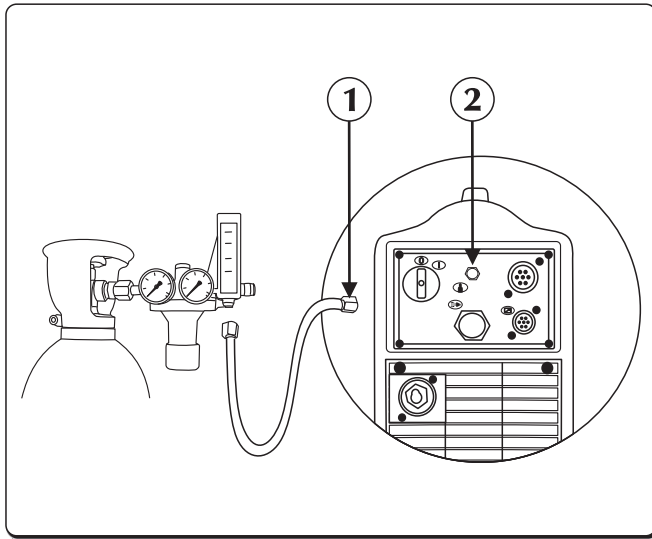

- ① Tubo de gás de tocha
- ② União/ligação de gás

- ▶ Ligar o tubo de gás proveniente da botija ao conector de gás posterior. Regular o fluxo do gás de 5 a 15 l/min.

3. APRESENTAÇÃO DO SISTEMA

PT

3.1 Painel traseiro

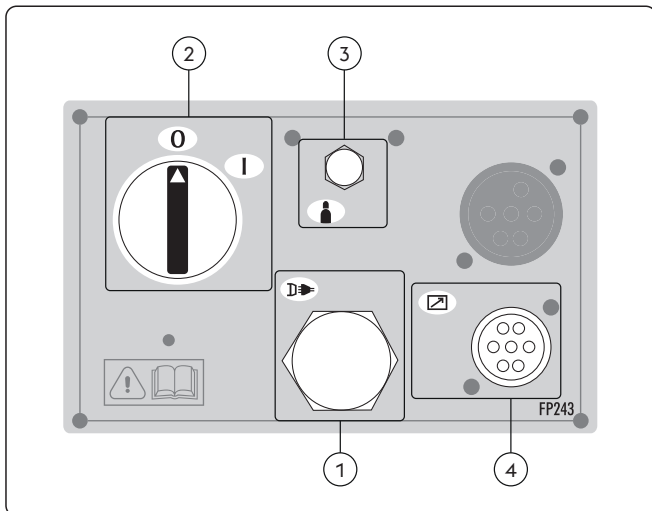

- ① Cabo de alimentação
Liga o sistema à rede eléctrica.
- ② Interruptor para ligar e desligar a máquina
Comanda a ligação eléctrica do sistema.
Tem duas posições, "0" desligada e "I" ligada.
- ③ Conexão do gás
- ④ Entrada do CAN-BUS cabo de sinal (RC, RI...)

3.2 Painel de tomadas

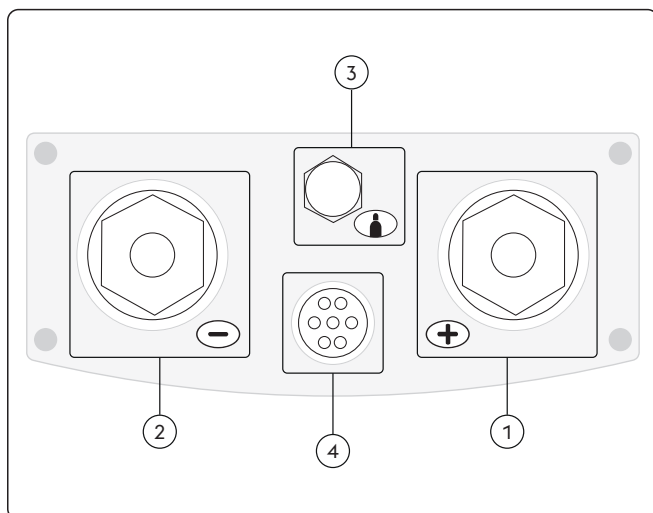



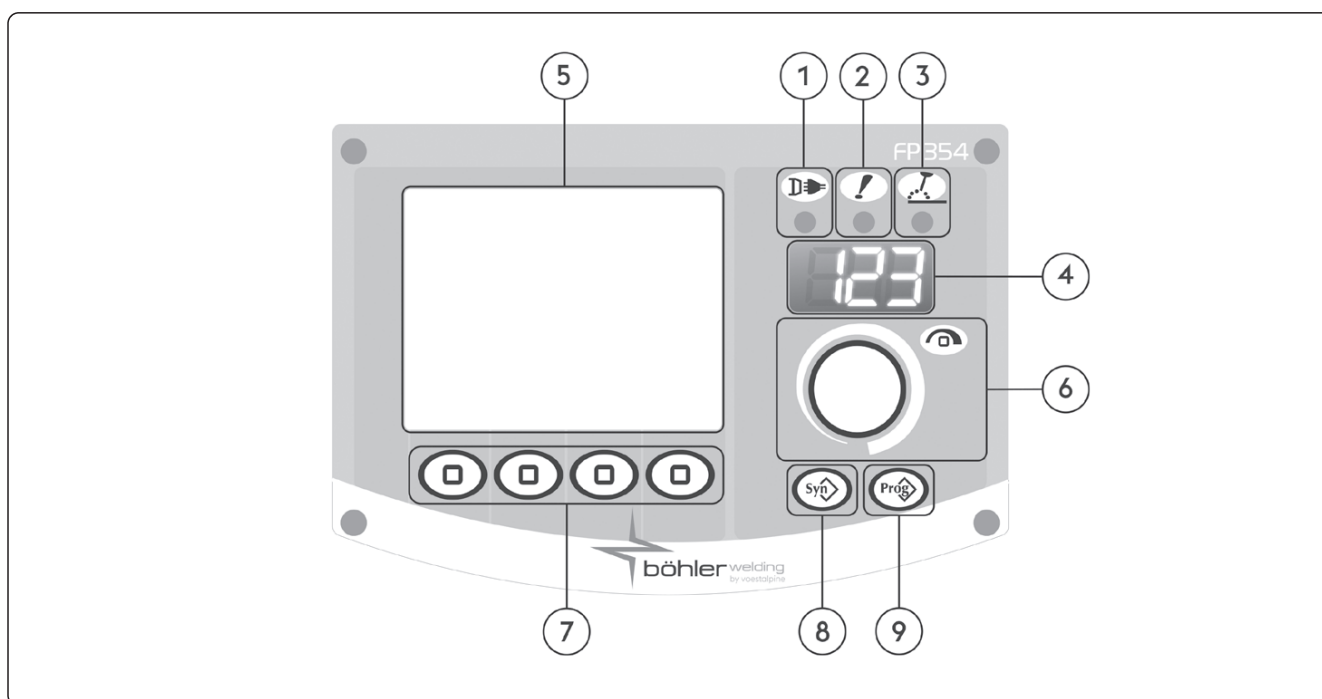

- ① **Tomada positiva de potência (+)**
 Processo MMA: Conexão tocha eletrodo
 Processo TIG: Conexão cabo terra
- ② **Tomada negativa de potência (-)**
 Processo MMA: Conexão cabo terra
 Processo TIG: Ligação do lança-chamas
- ③ **Conexão do gás**
- ④ **Entrada para cabo de sinal (lança-chamas TIG)**

3.3 Painel de comandos frontal





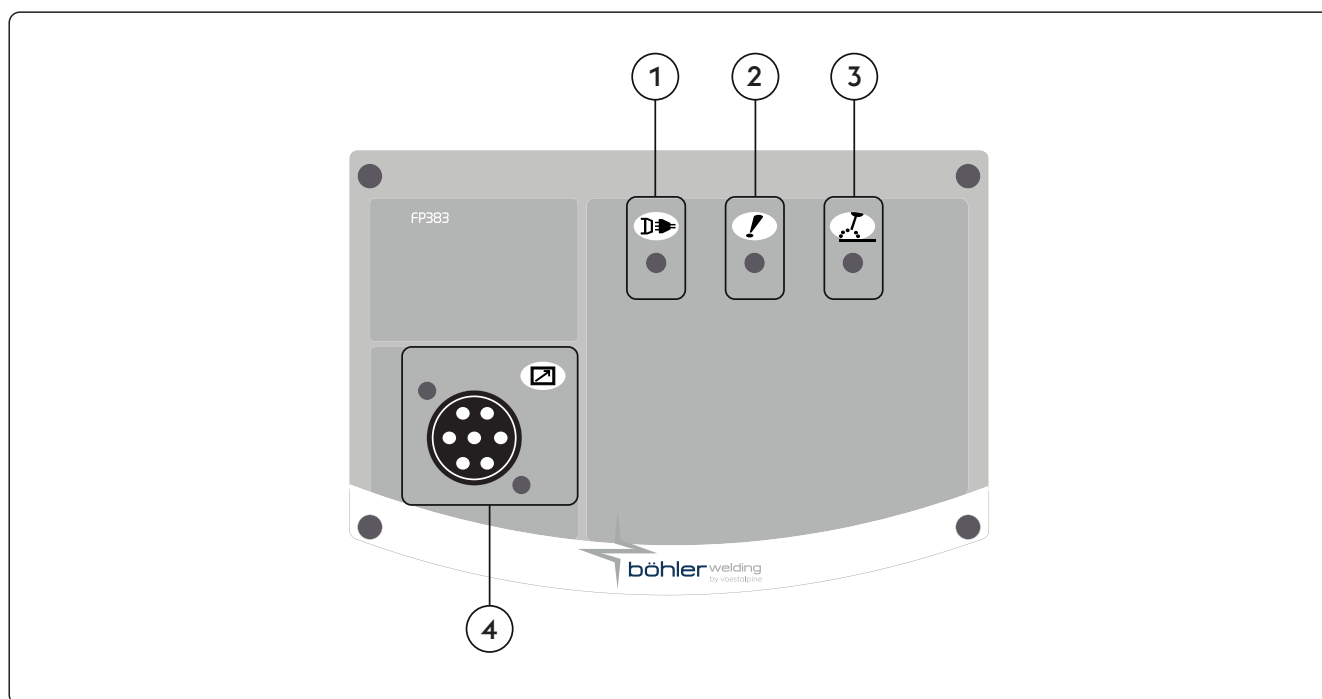

- ① **LED de alimentação**
 Indica que o equipamento está ligado à fonte de alimentação e se encontra activo.
- ② **LED de alarme geral**
 Indica a eventual intervenção de dispositivos de protecção, como a protecção de temperatura.
- ③ **LED de potência activa**
 Indica a presença de potência nas ligações de saída do equipamento.
- ④ **Visor de 7 segmentos**
 Permite que sejam apresentados os parâmetros gerais da máquina de soldar, durante a inicialização, a definição, a leitura da corrente e da potência, bem como durante a soldadura e codificação dos alarmes.
- ⑤ **Visor LCD**
 Permite que sejam apresentados os parâmetros gerais da máquina de soldar, durante a inicialização, a definição, a leitura da corrente e da potência, bem como durante a soldadura e codificação dos alarmes. Permite que todas as operações sejam apresentadas instantaneamente.

PT

- 6  **Manípulo de regulação principal**
 Permite que a corrente de soldadura seja permanentemente ajustada.
 Permite a acesso à configuração, selecção e definição dos parâmetros de soldadura.
- 7  **Teclas de função**
 Permite seleccionar as diversas funções do sistema:
 - Processo de soldadura
 - Métodos de soldadura
 - Pulsação de corrente
 - Modo gráfico
- 8  **Botão não utilizado**
- 9  **Botão job**
 Permite o armazenamento e gestão de 240 job, que podem ser personalizados pelo operador.



- 1  **LED de alimentação**
 Indica que o equipamento está ligado à fonte de alimentação e se encontra activo.
- 2  **LED de alarme geral**
 Indica a eventual intervenção de dispositivos de protecção, como a protecção de temperatura.
- 3  **LED de potência activa**
 Indica a presença de potência nas ligações de saída do equipamento.
- 4  **Entrada do CAN-BUS cabo de sinal (RC, RI...)**

4. UTILIZAÇÃO DO EQUIPAMENTO

4.1 Ecrã inicial

Ao ser ligado, o sistema efetua uma série de verificações para garantir que ele e todos os dispositivos a ele ligados funcionam corretamente. Nesta fase, o teste de gás também é executado para verificar a correcta ligação ao sistema de alimentação de gás.

4.2 Ecrã principal

Permite o controlo do sistema e do processo de soldadura, apresentando as definições principais.

4.3 Ecrã principal do processo MMA

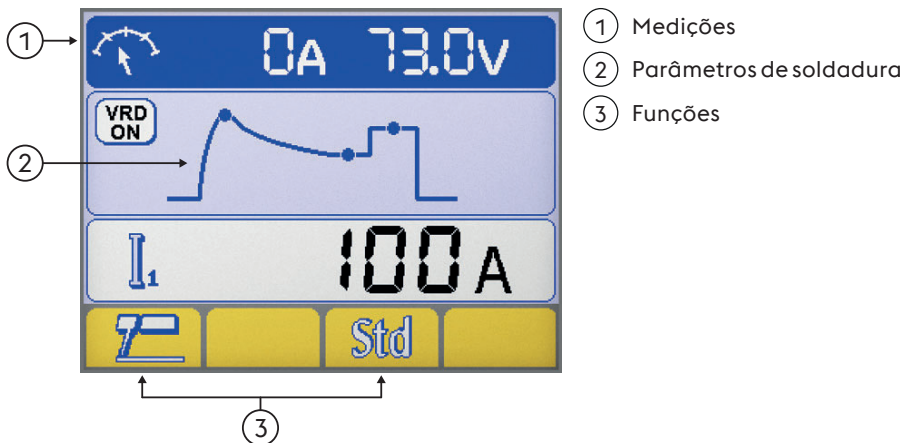

Medições

Durante a operação de soldadura, os valores reais de corrente e de tensão são apresentados no visor LCD.



Parâmetros de soldadura

► Premir a tecla de codificação ("encoder"), para seleccionar o parâmetro pretendido.

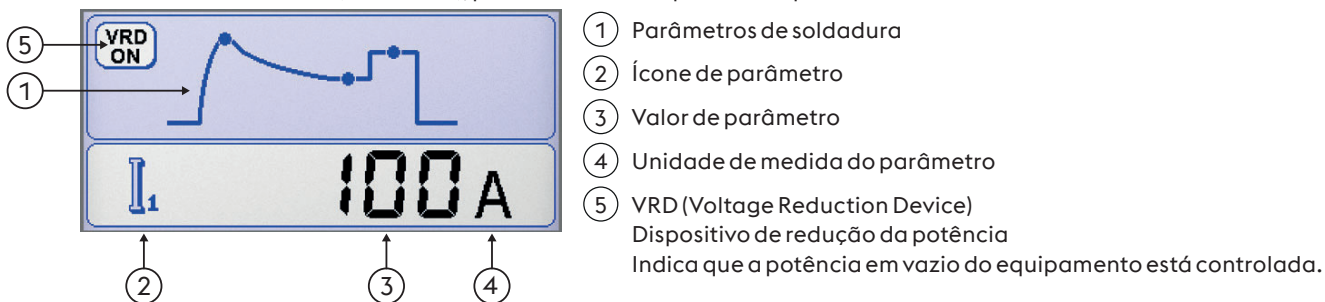

Funções

Permite a definição das funções de processo e métodos de soldadura mais importantes.



Processo de soldadura

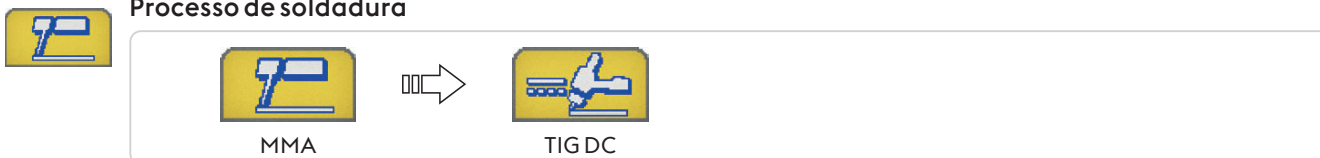

PT



Sinergia MMA

Permite definir a melhor dinâmica do arco seleccionando o tipo de eléctrodo utilizado.

Seleccionar correctamente a dinâmica do arco permite maximizar os benefícios provenientes do gerador, com o objectivo de obter o melhor desempenho de soldadura possível.



A perfeita soldabilidade do eléctrodo utilizado não é garantida

A soldabilidade depende da qualidade dos consumíveis e do respectivo estado de conservação, das condições de funcionamento e de soldadura, de numerosas aplicações possíveis, etc.

4.4 TIG folyamat főképnyő

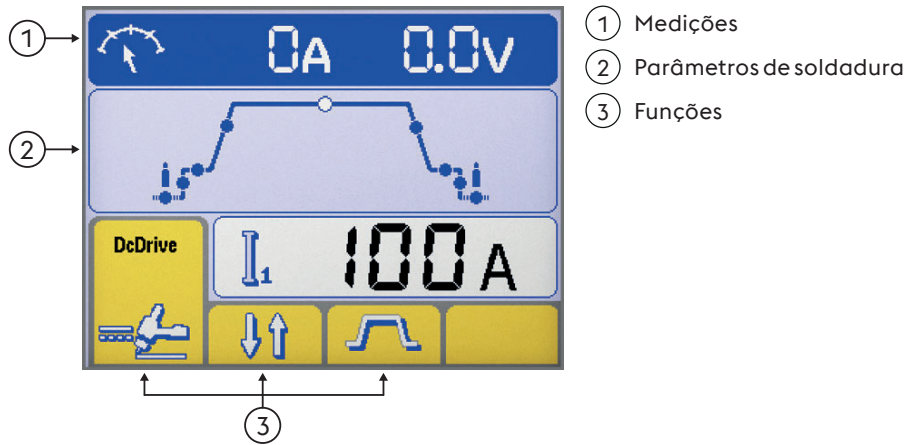

- ① Medições
- ② Parâmetros de soldadura
- ③ Funções

PT

Medições

Durante a operação de soldadura, os valores reais de corrente e de tensão são apresentados no visor LCD.

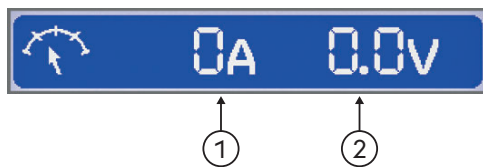

- ① Corrente de soldadura
- ② Tensão de soldadura

Parâmetros de soldadura

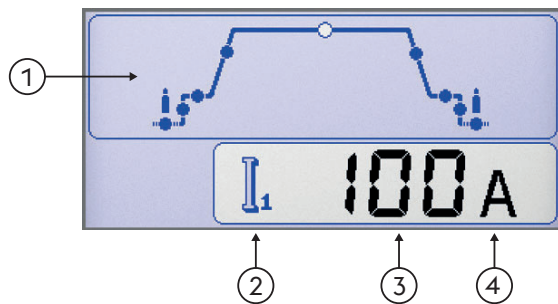

- ① Parâmetros de soldadura
 - ▶ Premir a tecla de codificação ("encoder"), para seleccionar o parâmetro pretendido.
 - ▶ Rodar a tecla de codificação ("encoder"), para regular o valor do parâmetro seleccionado.
- ② Ícone de parâmetro
- ③ Valor de parâmetro
- ④ Unidade de medida do parâmetro

Funções

Permite a definição das funções de processo e métodos de soldadura mais importantes.

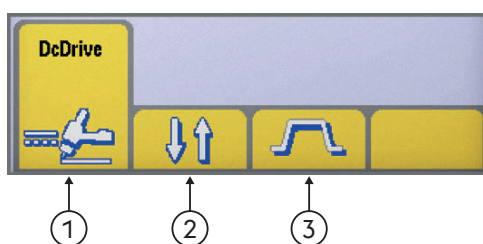

- ① Processo de soldadura
- ② Métodos de soldadura
- ③ Pulsação de corrente



Processo de soldadura

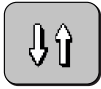

Métodos de soldadura

Permite a selecção do método de soldadura



2 Fases

Em 2 Fases, carregar no botão provoca o fluxo de gás, fazendo com que atinja o arco; quando o botão é solto, a corrente regressa a zero na descida de declive; quando o arco é desactivado, o gás passa ao período pós-gás.



4 Fases

Em 4 Fases a primeira vez que se carrega no botão provoca o fluxo de gás, executando o pré-gás manual; quando é solto, o arco é atingido.



Bilevel

Em bilevel o soldador pode soldar com duas correntes diferentes, definidas previamente. A primeira vez que se carrega no botão provoca o início do período pré-gás, o atingir do arco e a soldadura com a corrente inicial. A primeira vez que se solta o botão provoca a subida de declive da corrente "I1". Se o soldador carregar e soltar o botão rapidamente, muda para "I2". Carregar e soltar o botão rapidamente provoca o regresso a "I1" e assim sucessivamente. Pressionando por um período de tempo mais longo, inicia a rampa de descida da corrente que conduz à corrente final. Soltar o botão provoca a desactivação do arco, enquanto o gás continua o fluxo para o período pós-gás.



Pulsação de corrente



Corrente constante



Corrente pulsada



Fast Pulse



EasyArc

4.5 Ecrã de programamas



Permite o armazenamento e gestão de 240 job, que podem ser personalizados pelo operador.

Programas (JOB)

Consultar a secção "Ecrã principal"

Armazenamento de programas

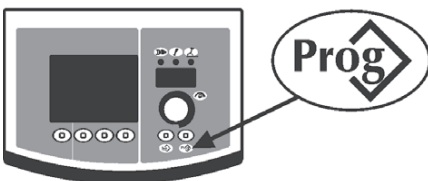

- ▶ Carregar no botão para aceder ao menu "armazenamento de programas".



- ▶ Rodar a tecla de codificação ("encoder"), para seleccionar o programa pretendido (ou a memória vazia).

--- Memória vazia

Programa armazenado

- ▶ Carregar no botão, para confirmar a operação .
- ▶ Carregar no botão, para salvar todas as definições actuais no programa seleccionado. .

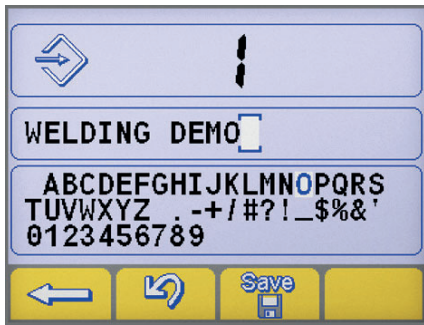

Introduzir uma descrição do programa.

- ▶ Rodar a tecla de codificação ("encoder"), para seleccionar a letra pretendida.
- ▶ Premir a tecla de codificação ("encoder"), para armazenar a letra pretendida.
- ▶ Carregar no botão, para anular a última letra.
- ▶ Carregar no botão, para confirmar a operação
- ▶ Carregar no botão, para confirmar a operação



O armazenamento de um novo programa num local da memória já ocupado, requer que esse local da memória seja cancelado, através de um procedimento obrigatório.



- ▶ Carregar no botão, para confirmar a operação
- ▶ Carregar no botão, para remover o programa seleccionado.
- ▶ Retomar o processo de armazenamento.

Recuperação de programas

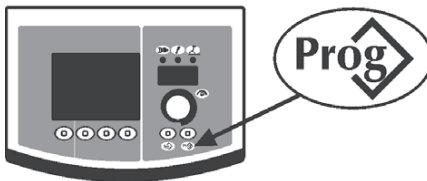

- ▶ Carregar no botão, para recuperar o 1º programa disponível
- ▶ Rodar a tecla de codificação ("encoder"), para seleccionar o programa pretendido.
- ▶ Carregar no botão, para seleccionar o programa pretendido.



São recuperados apenas os locais da memória ocupados por um programa, sendo automaticamente ignorados os locais vazios.

Cancelamento de programas



- ▶ Rodar a tecla de codificação ("encoder"), para seleccionar o programa pretendido.
- ▶ Carregar no botão, para remover o programa seleccionado.
- ▶ Carregar no botão, para confirmar a operação



- ▶ Carregar no botão, para confirmar a operação
- ▶ Carregar no botão, para remover o programa seleccionado.

5. DEFINIÇÕES

5.1 Definições e definição dos parâmetros

Permite a definição e a regulação de uma série de parâmetros adicionais para um controlo melhorado e mais preciso do sistema de soldadura.

Os parâmetros presentes nas definições estão organizados em função do processo de soldadura seleccionado e possuem um código numérico.

Acesso a definições



- ▶ Carregar durante 5 segundos no botão encoder.
- ▶ A introdução será confirmada pela inscrição 0 que surge no visor.

Seleção e regulação do parâmetro desejado

- ▶ Rodar a tecla de codificação (“encoder”) até visualizar o código numérico relativo ao parâmetro.
- ▶ Neste momento, carregar na tecla de codificação permite a visualização do valor definido para o parâmetro seleccionado e a respectiva regulação.

Saída de definições

- ▶ Para sair da secção “regulação” premir novamente a tecla de codificação.
- ▶ Para sair de definições, aceder ao parâmetro “0” (guardar e sair) e premir a tecla de codificação.
- ▶ Carregar no botão, para confirmar a operação .
- ▶ Para guardar a alteração e sair da configuração, premir o botão: .

5.1.1 Lista dos parâmetros de definições (MMA)

0	Guardar e sair	Permite guardar as modificações e sair de definições.												
1	Reset	Permite redefinir todos os parâmetros para os valores predefinidos.												
3	Hot start	Permite regular o valor de “hot start” em MMA. Permite um início mais ou menos quente nas fases de ignição do arco, facilitando as operações iniciais.												
	Eléctrodo básico	Eléctrodo celulósico												
	<table border="1"> <thead> <tr> <th>Mínimo</th> <th>Máximo</th> <th>Predefinido</th> </tr> </thead> <tbody> <tr> <td>0/off</td> <td>500%</td> <td>80%</td> </tr> </tbody> </table>	Mínimo	Máximo	Predefinido	0/off	500%	80%	<table border="1"> <thead> <tr> <th>Mínimo</th> <th>Máximo</th> <th>Predefinido</th> </tr> </thead> <tbody> <tr> <td>0/off</td> <td>500%</td> <td>150%</td> </tr> </tbody> </table>	Mínimo	Máximo	Predefinido	0/off	500%	150%
Mínimo	Máximo	Predefinido												
0/off	500%	80%												
Mínimo	Máximo	Predefinido												
0/off	500%	150%												
	Eléctrodo CrNi	Eléctrodo de alumínio												
	<table border="1"> <thead> <tr> <th>Mínimo</th> <th>Máximo</th> <th>Predefinido</th> </tr> </thead> <tbody> <tr> <td>0/off</td> <td>500%</td> <td>100%</td> </tr> </tbody> </table>	Mínimo	Máximo	Predefinido	0/off	500%	100%	<table border="1"> <thead> <tr> <th>Mínimo</th> <th>Máximo</th> <th>Predefinido</th> </tr> </thead> <tbody> <tr> <td>0/off</td> <td>500%</td> <td>120%</td> </tr> </tbody> </table>	Mínimo	Máximo	Predefinido	0/off	500%	120%
Mínimo	Máximo	Predefinido												
0/off	500%	100%												
Mínimo	Máximo	Predefinido												
0/off	500%	120%												
	Eléctrodo de ferro fundido	Eléctrodo rutilo												
	<table border="1"> <thead> <tr> <th>Mínimo</th> <th>Máximo</th> <th>Predefinido</th> </tr> </thead> <tbody> <tr> <td>0/off</td> <td>500%</td> <td>100%</td> </tr> </tbody> </table>	Mínimo	Máximo	Predefinido	0/off	500%	100%	<table border="1"> <thead> <tr> <th>Mínimo</th> <th>Máximo</th> <th>Predefinido</th> </tr> </thead> <tbody> <tr> <td>0/off</td> <td>500%</td> <td>80%</td> </tr> </tbody> </table>	Mínimo	Máximo	Predefinido	0/off	500%	80%
Mínimo	Máximo	Predefinido												
0/off	500%	100%												
Mínimo	Máximo	Predefinido												
0/off	500%	80%												
7	Corrente de soldadura	Permite regular a corrente de soldadura.												
	<table border="1"> <thead> <tr> <th>Mínimo</th> <th>Máximo</th> <th>Predefinido</th> </tr> </thead> <tbody> <tr> <td>3 A</td> <td>I_{max}</td> <td>100 A</td> </tr> </tbody> </table>	Mínimo	Máximo	Predefinido	3 A	I _{max}	100 A							
Mínimo	Máximo	Predefinido												
3 A	I _{max}	100 A												

PT

8

Arc force

Permite regular o valor do "Arc force" em MMA.

Permite uma resposta dinâmica mais ou menos energética em soldadura, facilitando as operações realizadas pelo soldador.

Aumentar o valor da força do arco para reduzir o risco de colagem do eléctrodo.

Eléctrodo básico

Mínimo	Máximo	Predefinido
0/off	500%	30%

Eléctrodo celulósico

Mínimo	Máximo	Predefinido
0/off	500%	350%

Eléctrodo CrNi

Mínimo	Máximo	Predefinido
0/off	500%	30%

Eléctrodo de alumínio

Mínimo	Máximo	Predefinido
0/off	500%	100%

Eléctrodo de ferro fundido

Mínimo	Máximo	Predefinido
0/off	500%	70%

Eléctrodo rutilo

Mínimo	Máximo	Predefinido
0/off	500%	80%

204

Dynamic power control (DPC)

Permite seleccionar a característica V/I pretendida.

I=C Corrente constante

O aumento ou redução da altura do arco não tem efeito na corrente de soldadura necessária.

Recomendado para eletrodo: Básico, Rutílico, Ácido, Aço, Ferro fundido

1:20 Diminuição do controlo de gradiente

O aumento da altura do arco provoca uma redução da corrente de soldadura (e vice-versa), de acordo com o valor determinado por 1 para 20 amperes por volt.

Recomendado para eletrodo: Celulósico, Alumínio

P=C Potência constante

O aumento da altura do arco provoca uma redução da corrente de soldadura (e vice-versa), de acordo com a lei: $V \cdot I = K$

Recomendado para eletrodo: Celulósico, Alumínio

312

Tensão de extinção do arco

Permite definir o valor de tensão que, ao ser atingido, força a extinção do arco eléctrico.

Permite uma melhor gestão das várias condições de funcionamento ocorridas.

Na fase de soldadura por pontos, por exemplo, uma baixa tensão de extinção do arco possibilita uma menor produção de chama no afastamento do eléctrodo da peça reduzindo salpicos, queimaduras e oxidação da peça.



Nunca definir uma tensão de extinção do arco maior do que a tensão em vazio do gerador.

Eléctrodo básico

Mínimo	Máximo	Predefinido
0/off	Vmax	57.0 V

Eléctrodo celulósico

Mínimo	Máximo	Predefinido
0/off	Vmax	70.0 V

399

Velocidade de corte

Permite definir a velocidade de soldadura.

Default cm/min: velocidade de referência para soldadura manual.

Syn: valor sinérgica.

Mínimo	Máximo	Predefinido
2 cm/min	200 cm/min	15 cm/min

500

Configuração da máquina

Permite seleccionar a interface gráfica pretendida.

Permite aceder aos níveis de definição superiores.

Consultar a secção "Personalização da interface (Set up 500)"

Valor	Nível seleccionado
USER	Utilizador
SERV	Service
vaBW	vaBW

Valor	Interface do Utilizador
XE	Modo Básico
XA	Modo Avançado
XP	Modo Profissional

551 Lock/unlock
 Permite o bloqueio dos controlos do painel e a introdução de um código de protecção.
 Consultar a secção "Lock/unlock (Set up 551)".



552 Tom avisador sonoro
 Permite a regulação do tom avisador sonoro.



Mínimo	Máximo	Predefinido
0/off	10	10

601 Passo de regulação
 Permite a regulação de um parâmetro, com um passo que pode ser personalizado pelo operador.



Mínimo	Máximo	Predefinido
1	Imax	1

602 Parâmetro externo 2
 Permite a gestão do parâmetro externo 2 (valor mínimo, valor máximo, valor predefinido, parâmetro seleccionado).



705 Calibração da resistência do circuito
 Permite calibrar o equipamento.
 Consultar a secção "Calibração da resistência do circuito (set up 705)".



751 Leitura de corrente
 Permite a apresentação do valor real da corrente de soldadura.



752 Leitura de tensão
 Permite a apresentação do valor real da tensão de soldadura.



768 Medição da aportação de calor HI
 Permite ler o valor medido da aportação de calor durante a soldadura.



5.1.2 Lista de parâmetros na configuração (TIG)

0 Guardar e sair
 Permite guardar as modificações e sair de definições.



1 Reset
 Permite redefinir todos os parâmetros para os valores predefinidos.



2 Pré-gás
 Permite definir e regular o fluxo de gás antes da ignição do arco.
 Permite o carregamento do gás na tocha e a preparação do ambiente para a soldadura.



Mínimo	Máximo	Predefinido
0/off	99.9 s	0.1 s

3 Corrente inicial
 Permite regular a corrente inicial de soldadura.
 Permite obter um banho de fusão mais ou menos quente, imediatamente após a ignição do arco.



Mínimo	Máximo	Predefinido	Mínimo	Máximo	Predefinido
1%	200%	50%	3 A	Imax	-

PT

5 Duração de corrente inicial

Permite a definição do período de tempo em que a corrente inicial é mantida.

Mínimo	Máximo	Predefinido
0/off	99.9 s	0/off

6 Rampa de subida

Permite definir uma passagem gradual entre a corrente inicial e a corrente de soldadura.

Mínimo	Máximo	Predefinido
0/off	99.9 s	0/off

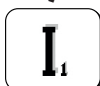
7 Corrente de soldadura

Permite regular a corrente de soldadura.

Mínimo	Máximo	Predefinido
3 A	I _{max}	100 A

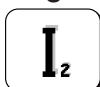
8 Corrente de duplo nível

Permite regular a corrente secundária na modalidade de soldadura de duplo nível.

À primeira pressão do botão da tocha obtém-se a pré-vazão do gás, a ignição do arco e a soldadura com corrente inicial.

À primeira libertação do botão obtém-se a rampa de subida à corrente "I1".

Se o soldador pressiona e solta rapidamente o botão passa-se a "I2".

Pressionando e soltando rapidamente o botão passa-se novamente a "I1" e assim adiante.

Pressionando por um período de tempo mais longo, inicia a rampa de descida da corrente que conduz à corrente final.

Soltando o botão produz-se o desligamento do arco enquanto que o gás continua a fluir pelo tempo de pós-vazão.

Mínimo	Máximo	Predefinido
3 A	I _{max}	-

Mínimo	Máximo	Predefinido
1%	500%	off

10 Corrente de base

Permite regular a corrente de base nos modos pulsado e pulsado rápido.

Mínimo	Máximo	Predefinido
3 A	I _{ald}	-

Mínimo	Máximo	Predefinido
1%	100%	50%

12 Frequência de pulsação

Permite regular a frequência de pulsação.

Permite obter melhores resultados na soldadura de materiais finos, bem como uma melhor qualidade estética do rebordo.

Mínimo	Máximo	Predefinido
0.1 Hz	25 Hz	5 Hz

13 Ciclo de funcionamento de pulsação

Permite regular o ciclo de funcionamento na soldadura por pulsação.

Permite que o pico de corrente seja mantido por um período de tempo mais ou menos longo.

Mínimo	Máximo	Predefinido
1 %	99 %	50 %

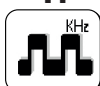
14 Frequência de pulsação rápida

Permite regular a frequência de pulsação.

Permite uma acção de concentração e a obtenção de uma melhor estabilidade do arco eléctrico.

Mínimo	Máximo	Predefinido
0.02 KHz	2.5 KHz	0.25 KHz

15 Declives de pulsação

Permite definir um tempo de declive, durante a operação de pulsação.

Permite obter uma variação gradual entre o pico de corrente e a corrente de base, obtendo um arco de soldadura mais ou menos suave.

Mínimo	Máximo	Predefinido
0/off	100 %	0/off

16 Rampa de descida

Permite definir uma passagem gradual entre a corrente de soldadura e a corrente final.

Mínimo	Máximo	Predefinido
0/off	99.9 s	0/off

17 Corrente final

Permite regular a corrente final.

Mínimo	Máximo	Predefinido	Mínimo	Máximo	Predefinido
3 A	I _{max}	10 A	1 %	200 %	50 %

19 Duração de corrente final

Possibilita a definição do período de tempo em que a corrente final é mantida.

Mínimo	Máximo	Predefinido
0/off	99.9 s	0/off

20 Pós-gás



Permite regular o fluxo de gás no fim da soldadura.

Mínimo	Máximo	Predefinido
0/off	99.9 s	syn

203 Tig start (HF)

Permite seleccionar os modos de ignição do arco.

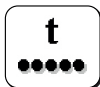
Valor	Predefinido	Função de retorno de chamada
on	X	HF START
off	-	LIFT START

204 Soldadura por pontos

Permite a activação do processo de "soldadura por pontos" e definir o tempo de soldadura.

Permite a temporização do processo de soldadura.

Mínimo	Máximo	Predefinido
0/off	99.9 s	0/off

205 Restart

Permite activar a função de reinicialização.

Permite a extinção imediata do arco durante a descida de declive ou a reinicialização do ciclo de soldadura.

Valor	Predefinido	Função de retorno de chamada
0/off	-	off
1/on	X	on
2/of1	-	off

206 Easy joining

Permite a ignição do arco em corrente pulsada e temporização da função antes da reposição automática das condições de soldadura predefinidas.

Permite maior velocidade e precisão durante operações de soldadura descontínua nas peças.

Mínimo	Máximo	Predefinido
0.1 s	25.0 s	0/off

208 Microtime spot welding

Permite activar o processo "microtime spot welding".

Permite a temporização do processo de soldadura.

Mínimo	Máximo	Predefinido
0.01 s	1.00 s	0/off

PT

399 Velocidade de corte

Permite definir a velocidade de soldadura.

Default cm/min: velocidade de referência para soldadura manual.

Syn: valor sinérgica.

Mínimo	Máximo	Predefinido
2 cm/min	200 cm/min	10 cm/min

500 Configuração da máquina

Permite seleccionar a interface gráfica pretendida.

Permite aceder aos níveis de definição superiores.

Consultar a secção "Personalização da interface (Set up 500)"

Valor	Nível seleccionado	Valor	Interface do Utilizador
USER	Utilizador	XE	Modo Básico
SERV	Service	XA	Modo Avançado
vaBW	vaBW	XP	Modo Profissional

551 Lock/unlock

Permite o bloqueio dos controlos do painel e a introdução de um código de protecção.

Consultar a secção "Lock/unlock (Set up 551)".

552 Tom avisador sonoro

Permite a regulação do tom avisador sonoro.

Mínimo	Máximo	Predefinido
0/off	10	10

601 Passo de regulação

Permite a regulação de um parâmetro, com um passo que pode ser personalizado pelo operador.

Mínimo	Máximo	Predefinido
1	lmax	1

602 Parâmetro externo CH1, CH2, CH3, CH4

Permite a gestão do parâmetro externo 1, 2, 3, 4 (valor mínimo, valor máximo, valor predefinido, parâmetro seleccionado).

Consultar a secção "Gestão de controlos externos (Set up 602)".

606 Tocha U/D

Permite a gestão do parâmetro externo (U/D).

Valor	Predefinido	Função de retorno de chamada
0/off	-	off
1/11	X	Corrente
	-	Recuperação de programas

612 Configuração do lança-chamas DgTig

Permite a gestão de canais do lança-chamas digital.

Valor	Predefinido	Função de retorno de chamada
0/off	-	off
1/11	-	Corrente
2/ 	-	Recuperação de programas
3/CH3	-	CH3
4/CH4	-	CH4
5/STD	X	STD

705
Calibração da resistência do circuito

Permite calibrar o equipamento.

Consultar a secção "Calibração da resistência do circuito (set up 705)".

751
Leitura de corrente

Permite a apresentação do valor real da corrente de soldadura.

752
Leitura de tensão

Permite a apresentação do valor real da tensão de soldadura.

758
Velocidade de movimentação de robô

Permite a apresentação da velocidade de movimentação de um braço robotizado ou automatizado.

764
Medição do fluxo do líquido de refrigeração

Permite visualizar o valor do fluxo do líquido de refrigeração.

765
Leitura de temperatura do líquido de refrigeração

Permite a apresentação do valor real de temperatura do líquido de refrigeração.

768
Medição da aportação de calor HI

Permite ler o valor medido da aportação de calor durante a soldadura.

801
Limites de segurança

Permite a definição dos limites de aviso e dos limites de segurança.

Permite o controlo do processo de soldadura, através da definição de limites de aviso e limites de segurança, aplicáveis aos principais parâmetros mensuráveis.

Permite o controlo preciso das várias fases de soldadura.



PT

5.2 Procedimentos específicos de utilização dos parâmetros

5.2.1 Personalização do visor de 7 segmentos

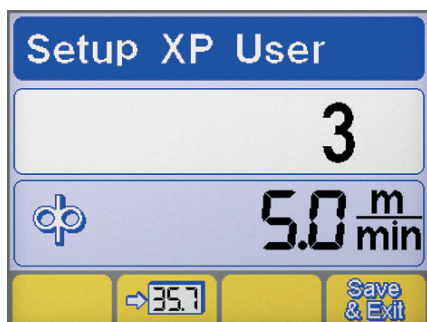
Permite ver constantemente o valor de um parâmetro no visor de 7 segmentos.



- ▶ Premir a tecla de codificação ("encoder") durante, pelo menos, 5 segundos, para aceder às definições.
- ▶ Rodar a tecla de codificação ("encoder").
- ▶ Carregar no botão, para armazenar o parâmetro seleccionado no visor de 7 segmentos .
- ▶ Carregar no botão, para salvar e sair do ecrã actual .

5.2.2 Personalização da interface (Set up 500)

Permite que os parâmetros sejam personalizados no menu principal.

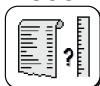
500
Configuração da máquina

Permite seleccionar a interface gráfica pretendida.

Valor	Interface do Utilizador
XE	Modo Básico
XA	Modo Avançado
XP	Modo Profissional

MODO XE

MMA	
Parâmetros de soldadura	
TIG	
Parâmetros de soldadura	
Funções	

MODO XA

MMA	
Parâmetros de soldadura	
Funções	
TIG	
Parâmetros de soldadura	
Funções	

MODO XP

MMA	
Parâmetros de soldadura	
Funções	
TIG	
Parâmetros de soldadura	
Funções	

5.2.3 Lock/unlock (Set up 551)

Permite o bloqueio dos controlos do painel e a introdução de um código de protecção.

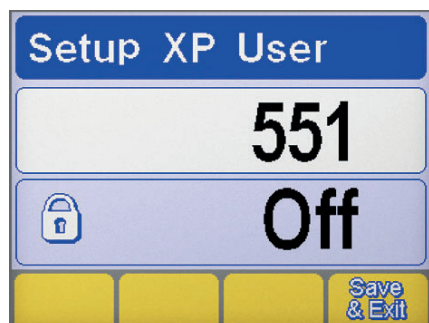

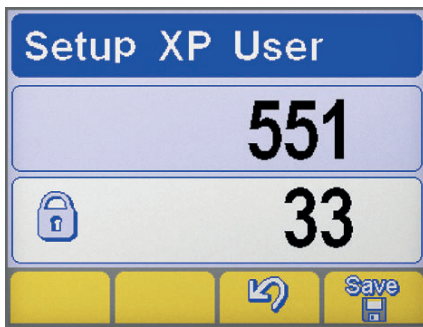

Seleção de parâmetro

- ▶ Premir a tecla de codificação ("encoder") durante, pelo menos, 5 segundos, para aceder às definições.
- ▶ Seleccionar o parâmetro pretendido (551).
- ▶ Premir a tecla de codificação ("encoder"), para activar a regulação do parâmetro seleccionado.



Definição da palavra passe

- ▶ Rodar a tecla de codificação (“encoder”), para definir um código numérico (palavra-passe).
- ▶ Premir o botão-encoder para confirmar a operação.
- ▶ Carregar no botão, para confirmar a operação .
- ▶ Para guardar a alteração, premir o botão: .

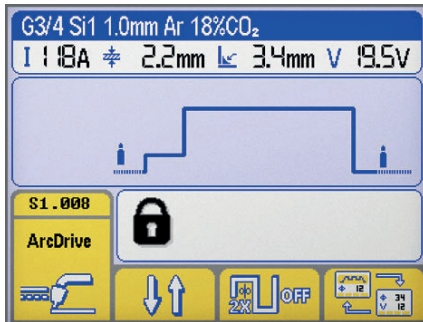

Funções do painel



A execução de qualquer operação num painel de controlo bloqueado faz surgir um ecrã especial.

- ▶ Rodar a tecla de codificação (“encoder”) e introduzir a palavra-passe correcta, para aceder temporariamente às funcionalidades do painel (5 minutos).
- ▶ Premir o botão-encoder para confirmar a operação.
- ▶ Aceder às definições (seguir as instruções dadas acima) e repor o parâmetro 551 em “off”, para desbloquear definitivamente o painel de controlo
- ▶ Premir o botão-encoder para confirmar a operação.
- ▶ Para guardar a alteração, premir o botão: .

5.2.4 Gestão de controlos externos (Set up 602)

Permite a gestão do parâmetro externo 2 (valor mínimo, valor máximo, valor predefinido, parâmetro seleccionado).



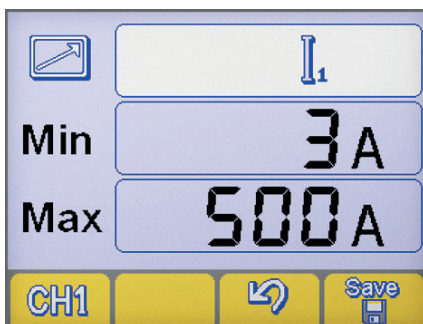

Seleção de parâmetro

- ▶ Premir a tecla de codificação (“encoder”) durante, pelo menos, 5 segundos, para aceder às definições.
- ▶ Seleccionar o parâmetro pretendido (602).
- ▶ Premir a tecla de codificação (“encoder”), para aceder ao ecrã “Gestão de controlos externos”.



Gestão de controlos externos

- ▶ Carregar no botão, para seleccionar a saída de comando à distância RC pretendida (CH1, CH2, CH3, CH4). .
- ▶ Premir a tecla de codificação (“encoder”), para seleccionar o parâmetro pretendido (Mín.-Máx-parâmetro).
- ▶ Rodar a tecla de codificação (“encoder”), para regular o parâmetro pretendido (Mín.-Máx-parâmetro).
- ▶ Para guardar a alteração, premir o botão: .
- ▶ Carregar no botão, para confirmar a operação .

5.2.5 Calibração da resistência do circuito (set up 705)

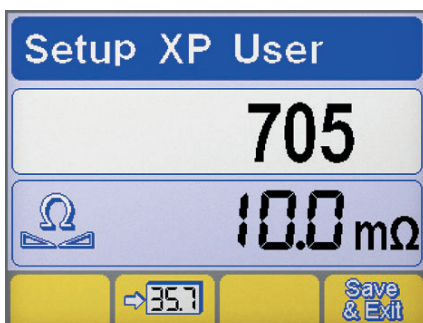

Seleção de parâmetro

- ▶ Premir a tecla de codificação (“encoder”) durante, pelo menos, 5 segundos, para aceder às definições.
- ▶ Seleccionar o parâmetro pretendido (705).
- ▶ Premir a tecla de codificação (“encoder”), para activar a regulação do parâmetro seleccionado.

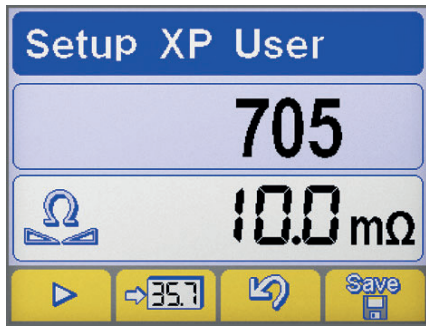

Calibração

- ▶ Colocar a eléctrodo de tungsténio em contacto eléctrico com a peça de trabalho. (TIG)
- ▶ Coloque a tocha porta-eletrodo em contato com a peça a ser soldada. (MMA)
- ▶ Premir o botão (ou gatilho da tocha) para começar o procedimento.
- ▶ Manter o contacto durante, pelo menos, um segundo.
- ▶ O valor exibido no visor será atualizado no final da calibração.
- ▶ Carregar no botão, para confirmar a operação .
- ▶ Carregar no botão, para confirmar a operação .
- ▶ Para guardar a alteração e sair da configuração, premir o botão: .

5.2.6 Limites de segurança (Set up 801)

Permite a definição dos limites de aviso e dos limites de segurança.

Permite o controlo do processo de soldadura, através da definição de limites de aviso e limites de segurança, aplicáveis aos principais parâmetros mensuráveis.

Permite o controlo preciso das várias fases de soldadura.

Consultar a secção "Limites de segurança (Set up 801)".

Limites de atenção		Limites de segurança	
		MIN	MAX
Corrente de soldadura			Tensão de soldadura
Leitura do fluxo de gás			Velocidade de movimentação de robô
Leitura de corrente (motor 1)			Leitura de corrente (motor 2)
Medição do fluxo do líquido de refrigeração			Leitura de velocidade do fio
Leitura de temperatura do líquido de refrigeração			

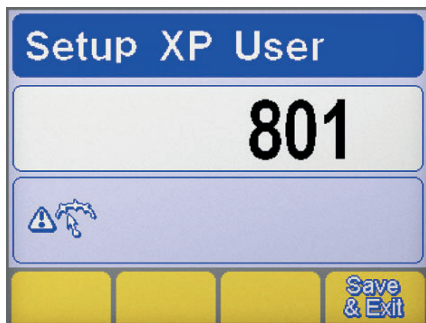

Seleção de parâmetro

- ▶ Premir a tecla de codificação ("encoder") durante, pelo menos, 5 segundos, para aceder às definições.
- ▶ Seleccionar o parâmetro pretendido (801).
- ▶ Premir a tecla de codificação ("encoder"), para aceder ao ecrã "Limites de segurança".

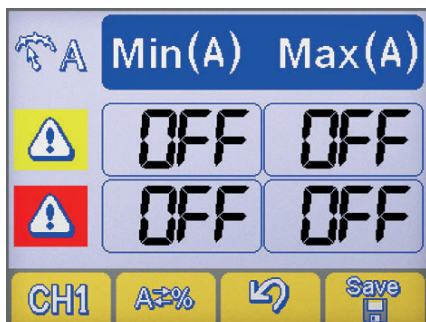

Seleção do parâmetro

- ▶ Carregar no botão para seleccionar o parâmetro pretendido .
- ▶ Carregar no botão para seleccionar o método de definição dos limites de segurança .

Configuração da máquina

Valor absoluto

Valor percentual

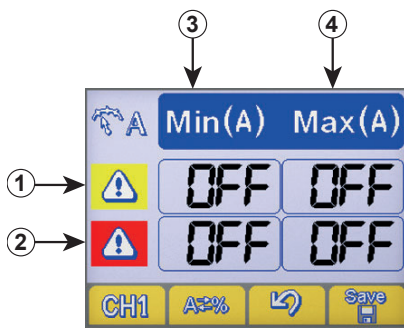
Definição dos limites de alerta

- ① Linha dos limites de aviso
- ② Linha dos limites de alarme
- ③ Coluna de níveis mínimos
- ④ Coluna de níveis máximos

- ▶ Premir a tecla de codificação (“encoder”), para seleccionar a caixa pretendida (a caixa seleccionada é apresentada com inversão de contraste).
- ▶ Rodar a tecla de codificação (“encoder”), para regular o nível do limite seleccionado.
- ▶ Para guardar a alteração, premir o botão: .



- Ultrapassar um dos limites de aviso faz surgir um sinal visual no painel de controlo.
- Ultrapassar um dos limites de alarme faz surgir um sinal visual no painel de controlo e provoca o bloqueio imediato das operações de soldadura.
- É possível definir filtros de soldadura iniciais e finais, para evitar sinais de erro na ignição e extinção do arco (consultar a secção “Definições” - Parâmetros 802-803-804).

6. MANUTENÇÃO



A instalação deve ser submetida a operações de manutenção de rotina, de acordo com as indicações do fabricante. Quando o equipamento está em funcionamento, todas as portas e tampas de acesso e de serviço deverão estar fechadas e trancadas. Os sistemas não devem ser submetidos a qualquer tipo de modificação. Evitar a acumulação de poeiras condutoras de electricidade perto das aletas de ventilação e sobre as mesmas.



As operações de manutenção deverão ser efectuadas exclusivamente por pessoal especializado. A reparação ou substituição de componentes do sistema que seja executada por pessoal não-autorizado implica a imediata anulação da garantia do produto. A eventual reparação ou substituição de componentes do sistema tem de ser executada exclusivamente por pessoal técnico qualificado.



Antes da qualquer operação de manutenção, desligar o equipamento da corrente eléctrica!

6.1 Efectuar periodicamente as seguintes operações

6.1.1 Anlegg



Limpar o interior do gerador com ar comprimido a baixa pressão e com escovas de cerdas suaves. Verificar as ligações eléctricas e todos os cabos de ligação.

6.1.2 Para a manutenção ou substituição de componentes da tocha, do porta-eléctrodos e/ou dos cabos de terra:



Verificar a temperatura dos componentes e assegurar-se de que não estão sobreaquecidos.



Utilizar sempre luvas conformes às normas de segurança.



Utilizar chaves inglesas e ferramentas adequadas.

6.2 Ansvr



Caso a referida manutenção não seja executada, todas as garantias serão anuladas, isentando o fabricante de toda e qualquer responsabilidade. O incumprimento destas instruções isentará o fabricante de toda e qualquer responsabilidade. Se tiver quaisquer dúvidas e/ou problemas, não hesite em contactar o centro de assistência técnica mais perto de si.

7. CÓDIGOS DE ALARME



ALARME

A intervenção de um alarme ou a superação de um limite de alerta crítico provoca um sinal visual no painel de comando e o bloqueio imediato das operações de soldadura.



ATENÇÃO

A ultrapassagem de um limite de alerta provoca uma assinalação visual no painel de comando, mas permite continuar as operações de soldadura.

Incluimos, a seguir, uma lista com todos os alarmes e limites de alerta inerentes ao sistema.

E01	Sobret temperatura		E02	Sobret temperatura	
E03	Sobret temperatura		E05	Sobrecorrente	
E06	Sobrecorrente do módulo de potência (Boost)		E07	Erro no sistema de alimentação do motor do puxador de fio	
E08	Motor bloqueado		E10	Sobrecorrente do módulo de potência (Inverter)	
E11	Erro de configuração do sistema		E13	Erro de comunicação (FP)	
E14.xx	Programa inválido o subcódigo de erro indica o número do trabalho eliminado.		E15	Programa inválido	
E16	Erro de comunicação (RI) (Automatização e robótico)		E18.xx	Programa inválido o subcódigo de erro indica o número do trabalho eliminado.	
E19	Erro de configuração do sistema		E20	Memória defeituosa	
E21	Perda de dados		E22	Erro de comunicação (DSP)	
E27	Memória defeituosa (RTC)		E29	Medidas incompatíveis	
E30	Erro de comunicação (H.F.)		E32	Perda de dados	
E33	Erro de configuração do sistema (LCD 3.5")		E38	Subtensão	
E39	Falha na alimentação do equipamento		E40	Falha na alimentação do equipamento	

 E41	Sobretensão		 E42	Subtensão	
 E43	Falta de líquido refrigerante		 E49	Interruptor de emergência (Automatização e robótico)	
 E51	Definições não suportadas (Automatização e robótico)		 E52	Anticolisão (Automatização e robótico)	
 E53	Erro do fluxostato externo (Automatização e robótico)		 E54	Nível de corrente ultrapassado (Limite inferior)	
 E55	Nível de corrente ultrapassado (Limite superior)		 E56	Nível de tensão ultrapassado (Limite inferior)	
 E57	Nível de tensão ultrapassado (Limite superior)		 E58	Nível de fluxo de gás ultrapassado (Limite inferior)	
 E59	Nível de fluxo de gás ultrapassado (Limite superior)		 E62	Nível de corrente ultrapassado (Limite inferior)	
 E63	Nível de corrente ultrapassado (Limite superior)		 E64	Nível de tensão ultrapassado (Limite inferior)	
 E65	Nível de tensão ultrapassado (Limite superior)		 E66	Nível de fluxo de gás ultrapassado (Limite inferior)	
 E67	Nível de fluxo de gás ultrapassado (Limite superior)		 E71	Sobretensão do líquido refrigerante	
 E72	Sobrecorrente no motor push-pull		 E73	Limite de velocidade do fio ultrapassado (speed meter)	
 E75	Nível de corrente do motor 2 ultrapassado		 E76	Nível de fluxo do líquido refrigerante ultrapassado	
 E77	Nível de temperatura do líquido refrigerante		 E78	Manutenção ativa (Automatização e robótico)	
 E81	Sobrecorrente (bomba WU)		 E82	Erro de comunicação (WU)	
 E83	Bomba bloqueada		 E99	Alarme geral	

PT

8. RESOLUÇÃO DE PROBLEMAS

A instalação não é activada (LED verde apagado)

Causa	Solução
» Tomada de alimentação sem tensão.	» Verificar e reparar o sistema eléctrico, conforme necessário. » Recorrer a pessoal especializado.
» Ficha ou cabo de alimentação danificado.	» Substituir o componente danificado. » Contactar o centro de assistência mais próximo para a reparação do sistema.
» Fusível geral queimado.	» Substituir o componente danificado.
» Interruptor de funcionamento danificado.	» Substituir o componente danificado. » Contactar o centro de assistência mais próximo para a reparação do sistema.
» Sistema electrónico danificado.	» Contactar o centro de assistência mais próximo para a reparação do sistema.

Não há potência na saída (a máquina não solda)

Causa	Solução
» Botão de accionamento da tocha danificado.	» Substituir o componente danificado. » Contactar o centro de assistência mais próximo para a reparação do sistema.
» Instalação em sobreaquecimento (alarme de temperatura - LED amarelo aceso).	» Aguardar que o sistema arrefeça, sem o desligar.
» Ligação à terra incorrecta.	» Executar correctamente a ligação de terra. » Consultar a secção "Instalação".
» Tensão de rede fora dos limites (LED amarelo aceso).	» Colocar a tensão de rede dentro dos limites de alimentação do gerador. » Executar correctamente a ligação da instalação. » Consultar a secção "Ligações".
» Contactor danificado.	» Substituir o componente danificado. » Contactar o centro de assistência mais próximo para a reparação do sistema.
» Sistema electrónico danificado.	» Contactar o centro de assistência mais próximo para a reparação do sistema.

Potência de saída incorrecta

Causa	Solução
» Selecção incorrecta do processo de soldadura ou comutador de selecção defeituoso.	» Seleccionar correctamente o processo de soldadura.
» Definição incorrecta dos parâmetros ou funções do sistema.	» Efectuar a reposição aos valores originais e redefinir os parâmetros de soldadura.
» Potenciómetro/"encoder" para regulação da corrente de soldadura danificado.	» Substituir o componente danificado. » Contactar o centro de assistência mais próximo para a reparação do sistema.
» Tensão de rede fora dos limites.	» Executar correctamente a ligação da instalação. » Consultar a secção "Ligações".
» Ausência de uma fase de entrada.	» Executar correctamente a ligação da instalação. » Consultar a secção "Ligações".
» Sistema electrónico danificado.	» Contactar o centro de assistência mais próximo para a reparação do sistema.

Instabilidade do arco

Causa	Solução
» Gás de protecção insuficiente.	» Regular correctamente o fluxo do gás. » Verificar se o difusor e o bico de gás da tocha se encontram em boas condições.

» Presença de humidade no gás de soldadura.

» Utilizar sempre produtos e materiais de qualidade.

» Manter sempre o sistema de alimentação do gás em perfeitas condições.

» Parâmetros de soldadura incorrectos.

» Verificar cuidadosamente a instalação de soldadura.

» Contactar o centro de assistência mais próximo para a reparação do sistema.

Projecção excessiva de salpicos

Causa

» Comprimento incorrecto do arco.

Solução

» Reduzir a distância entre o eléctrodo e a peça.

» Reduzir a tensão de soldadura.

» Parâmetros de soldadura incorrectos.

» Reduzir a tensão de soldadura.

» Gás de protecção insuficiente.

» Regular correctamente o fluxo do gás.

» Verificar se o difusor e o bico de gás da tocha se encontram em boas condições.

» Dinâmica do arco incorrecta.

» Aumentar o valor indutivo do circuito equivalente.

» Modo de execução da soldadura incorrecto.

» Reduzir o ângulo da tocha.

Penetração insuficiente

Causa

» Modo de execução da soldadura incorrecto.

Solução

» Reduzir a velocidade de avanço em soldadura.

» Parâmetros de soldadura incorrectos.

» Aumentar a corrente de soldadura.

» Eléctrodo incorrecto.

» Utilizar um eléctrodo com diâmetro inferior.

» Preparação incorrecta dos bordos.

» Aumentar a abertura do chanfro.

» Ligação à terra incorrecta.

» Executar correctamente a ligação de terra.

» Consultar a secção "Instalação".

» Peças a soldar demasiado grandes.

» Aumentar a corrente de soldadura.

Incrustações de escórias

Causa

» Remoção incompleta da escória.

Solução

» Limpar as peças devidamente, antes de executar a soldadura.

» Eléctrodo com diâmetro excessivo.

» Utilizar um eléctrodo com diâmetro inferior.

» Preparação incorrecta dos bordos.

» Aumentar a abertura do chanfro.

» Modo de execução da soldadura incorrecto.

» Reduzir a distância entre o eléctrodo e a peça.

» Avançar regularmente durante todas as fases da soldadura.

Inclusões de tungsténio

Causa

» Parâmetros de soldadura incorrectos.

Solução

» Reduzir a tensão de soldadura.

» Utilizar um eléctrodo com diâmetro superior.

» Eléctrodo incorrecto.

» Utilizar sempre produtos e materiais de qualidade.

» Afilar cuidadosamente o eléctrodo.

» Modo de execução da soldadura incorrecto.

» Evitar o contacto entre o eléctrodo e o banho de fusão.

Poros

Causa

» Gás de protecção insuficiente.

Solução

» Regular correctamente o fluxo do gás.

» Verificar se o difusor e o bico de gás da tocha se encontram em boas condições.

Colagem

Causa

» Comprimento incorrecto do arco.

Solução

» Aumentar a distância entre o eléctrodo e a peça

» Aumentar a tensão de soldadura.

» Parâmetros de soldadura incorrectos.

» Aumentar a corrente de soldadura.

» Aumentar a tensão de soldadura.

» Modo de execução da soldadura incorrecto.

» Aumentar o ângulo de inclinação da tocha.

» Peças a soldar demasiado grandes.

» Aumentar a corrente de soldadura.

» Aumentar a tensão de soldadura.

» Dinâmica do arco incorrecta.

» Aumentar o valor indutivo do circuito equivalente.

Bordos queimados

Causa

» Parâmetros de soldadura incorrectos.

Solução

» Reduzir a tensão de soldadura.

» Utilizar um eléctrodo com diâmetro inferior.

» Comprimento incorrecto do arco.

» Reduzir a distância entre o eléctrodo e a peça.

» Reduzir a tensão de soldadura.

» Modo de execução da soldadura incorrecto.

» Reduzir a velocidade de oscilação lateral no enchimento.

» Reduzir a velocidade de avanço em soldadura.

» Gás de protecção insuficiente.

» Utilizar gases adequados aos materiais a soldar.

Oxidações

Causa

» Gás de protecção insuficiente.

Solução

» Regular correctamente o fluxo do gás.

» Verificar se o difusor e o bico de gás da tocha se encontram em boas condições.

Porosità

Causa

» Presença de gordura, tinta, ferrugem ou sujidade nas peças a soldar.

Solução

» Limpar as peças devidamente, antes de executar a soldadura.

» Presença de gordura, tinta, ferrugem ou sujidade no material de adição.

» Utilizar sempre produtos e materiais de qualidade.

» Manter sempre o material de adição em perfeitas condições.

» Presença de humidade no material de adição.

» Utilizar sempre produtos e materiais de qualidade.

» Manter sempre o material de adição em perfeitas condições.

» Comprimento incorrecto do arco.

» Reduzir a distância entre o eléctrodo e a peça.

» Reduzir a tensão de soldadura.

» Presença de humidade no gás de soldadura.

» Utilizar sempre produtos e materiais de qualidade.

» Manter sempre o sistema de alimentação do gás em perfeitas condições.

» Gás de protecção insuficiente.

» Regular correctamente o fluxo do gás.

» Verificar se o difusor e o bico de gás da tocha se encontram em boas condições.

» Solidificação demasiado rápida do banho de fusão.

» Reduzir a velocidade de avanço em soldadura.

» Executar um pré-aquecimento das peças a soldar.

» Aumentar a corrente de soldadura.

Fissuras a quente

Causa

» Parâmetros de soldadura incorrectos.

Solução

» Reduzir a tensão de soldadura.

» Utilizar um eléctrodo com diâmetro inferior.

» Presença de gordura, tinta, ferrugem ou sujidade nas peças a soldar.

» Limpar as peças devidamente, antes de executar a soldadura.

» Presença de gordura, tinta, ferrugem ou sujidade no material de adição.

» Utilizar sempre produtos e materiais de qualidade.

» Manter sempre o material de adição em perfeitas condições.

» Modo de execução da soldadura incorrecto.

» Executar a sequência correcta de operações para o tipo de junta a soldar.

» Peças a soldar com características diferentes.

» Executar um amanteigamento antes de executar a soldadura.

Fissuras a frio

Causa	Solução
» Presença de humidade no material de adição.	» Utilizar sempre produtos e materiais de qualidade. » Manter sempre o material de adição em perfeitas condições.
» Geometria particular da junta a soldar.	» Executar um pré-aquecimento das peças a soldar. » Executar um pós-aquecimento. » Executar a sequência correcta de operações para o tipo de junta a soldar.

9. INSTRUÇÕES OPERACIONAIS

9.1 Soldadura manual por arco voltaico (MMA)

Preparação dos bordos

Para obter boas soldaduras é sempre recomendável trabalhar peças limpas, não oxidadas, sem ferrugem nem outros agentes contaminadores.

Escolha do eléctrodo

O diâmetro do eléctrodo a utilizar depende da espessura do material, da posição, do tipo de junção e do tipo de preparação a que a peça a soldar tenha sido sujeita.

Eléctrodos com maior diâmetro exigem, como é lógico, correntes muito elevadas, com um conseqüente fornecimento de calor muito intenso durante a soldadura.

Tipo de revestimento	Propriedades	Utilização
Rutilo	Facil. de utilização	Todas as posições
Ácido	Alta velocid. de fusão	Plano
Básico	Caract. Mecânicas	Todas as posições

Escolha da corrente de soldadura

Os valores da corrente de soldadura, relativamente ao tipo de eléctrodo utilizado, são especificados pelo fabricante na embalagem do eléctrodo.

Acender e manter o arco

O arco eléctrico é produzido por fricção da ponta do eléctrodo na peça de trabalho ligada ao cabo de terra e, logo que o arco estiver aceso, afastando rapidamente a vareta para a distância normal de soldadura.

Normalmente, para melhorar a ignição do arco, é fornecida uma corrente inicial superior, de modo a provocar um aquecimento súbito da extremidade do eléctrodo, para melhorar o estabelecimento do arco ("Hot Start").

Uma vez o arco aceso, inicia-se a fusão da parte central do eléctrodo que se deposita em forma de gotas no banho de fusão da peça a soldar.

O revestimento externo do eléctrodo é consumido, fornecendo o gás de protecção para a soldadura, assegurando assim que a mesma será de boa qualidade.

Para evitar que as gotas de material fundido apaguem o arco, por curto-circuito, e colem o eléctrodo ao banho de fusão, devido a uma aproximação acidental entre ambos, é disponibilizado um aumento temporário da corrente de soldadura, de forma a neutralizar o curto-circuito (Arc Force).

Caso o eléctrodo permaneça colado à peça a soldar, a corrente de curto-circuito deve ser reduzida para o valor mínimo ("antisticking").

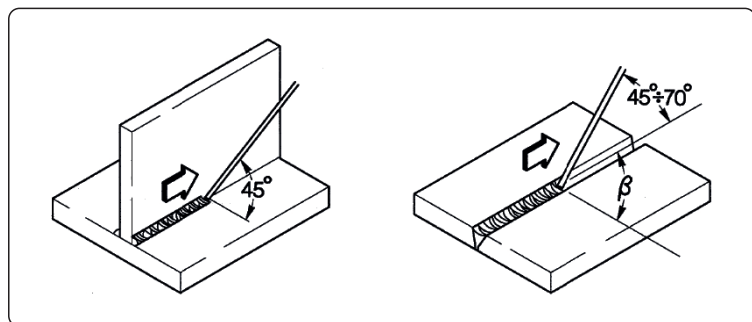

Execução da soldadura

L'angolo di inclinazione dell'elettrodo varia a seconda del numero delle passate, il movimento dell'elettrodo viene eseguito normalmente con oscillazioni e fermate ai lati del cordone in modo da evitare un accumulo eccessivo di materiale d'apporto al centro.

Remoção da escória

A soldadura por eléctrodos revestidos obriga à remoção da escória após cada passagem.

A escória é removida com um pequeno martelo ou com uma escova, se estiver fria.

9.2 Soldadura TIG (arco contínuo)

Descrição

O processo de soldadura TIG ("Tungsten Inert Gas" - Tungsténio Gás Inerte) baseia-se na presença de um arco eléctrico aceso entre um eléctrodo não consumível (tungsténio puro ou em liga, com uma temperatura de fusão de cerca de 3370° C) e a peça de trabalho; uma atmosfera de gás inerte (árgon) assegura a protecção do banho de fusão.

O eléctrodo nunca deve tocar na peça de trabalho, para evitar o perigo representado pela entrada de tungsténio na junta; por esse motivo, a fonte de alimentação de soldadura dispõe, normalmente, de um dispositivo de início do arco que gera uma descarga de alta frequência e alta tensão, entre a extremidade do eléctrodo e a peça de trabalho. Assim, devido à faísca eléctrica que ioniza a atmosfera gasosa, o arco de soldadura começa sem que haja contacto entre o eléctrodo e a peça de trabalho.

Existe ainda outro tipo de arranque com introduções reduzidas de tungsténio: o arranque em "lift" (elevação) que não requer alta frequência mas apenas um curto-circuito inicial, a baixa corrente, entre o eléctrodo e a peça a soldar; o arco inicia-se quando o eléctrodo sobe e a corrente aumenta até atingir o valor de soldadura previamente estabelecido.

Para melhorar a qualidade da parte final do cordão de soldadura é importante verificar com precisão a descida da corrente de soldadura e é necessário que o gás flua no banho de fusão por alguns segundos, após a finalização do arco.

Em muitas condições operativas é útil poder dispor de 2 correntes de soldadura predefinidas e poder passar facilmente de uma para outra (BILEVEL).

Polaridade de soldadura

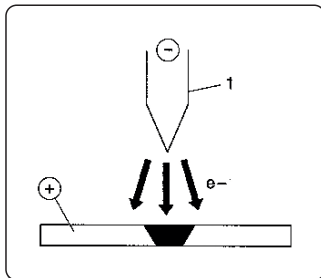

D.C.S.P. (Direct Current Straight Polarity - Polaridade Directa de Corrente Contínua)

Esta é a polaridade mais utilizada e assegura um desgaste limitado do eléctrodo (1), uma vez que 70 % do calor se concentra no ânodo (ou seja, na peça).

Com altas velocidades de avanço e baixo fornecimento de calor obtêm-se banhos de solda estreitos e fundos.

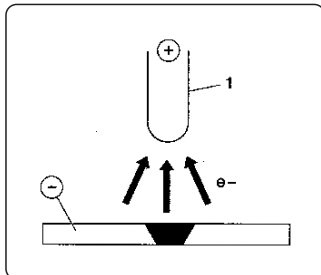

D.C.R.P. (Direct Current Reverse Polarity - Polaridade Inversa de Corrente Contínua)

A polaridade inversa é utilizada na soldadura de ligas cobertas com uma camada de óxido refractário, com uma temperatura de fusão superior à dos metais.

Não se podem utilizar correntes elevadas, uma vez que estas provocariam um desgaste excessivo do eléctrodo.

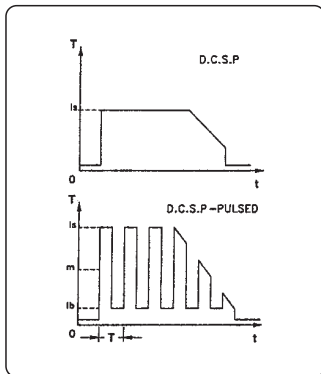

D.C.S.P.-Pulsed (Direct Current Straight Polarity Pulsed - Pulsação de Polaridade Directa de Corrente Contínua)

A adopção de uma corrente contínua pulsada permite controlar melhor o banho de fusão, em condições operacionais específicas.

O banho de fusão é formado pelos impulsos de pico (I_p), enquanto a corrente de base (I_b) mantém o arco aceso; isto facilita a soldadura de pequenas espessuras, com menos deformações, melhor factor de forma e conseqüente menor perigo de formação de fendas a quente e de introduções gasosas.

Com o aumento da frequência (média frequência) obtém-se um arco mais estreito, mais concentrado e mais estável, o que permite uma melhor qualidade de soldadura de espessuras finas.

Características das soldaduras TIG

O procedimento TIG é muito eficaz na soldadura dos aços, quer sejam de carbono ou resultem de ligas, para a primeira passagem sobre os tubos e nas soldaduras que devam apresentar bom aspecto estético.

É necessária polaridade directa (D.C.S.P.).

Preparação dos bordos

Torna-se necessário efectuar uma limpeza cuidadosa bem como uma correcta preparação dos bordos.

Escolha e preparação do eléctrodo

Aconselhamos o uso de eléctrodos de tungsténio toriado (2% de tório-coloração vermelha) ou, em alternativa, eléctrodos de cério ou lantânio com os seguintes diâmetro:

Limites de corrente			Eléctrodo	
(DC-)	(DC+)	(AC)	Ø	α
3-20 A	-	3-20 A	0,5 mm	30°
15-80 A	-	20-30 A	1,0 mm	30-60°
70-150 A	10-20 A	30-80 A	1,6 mm	60-90°
150-250 A	15-30 A	60-130 A	2,4 mm	90-120°
250-400 A	25-40 A	100-180 A	3,2 mm	120-150°
400-500 A	40-55 A	160-240 A	4,0 mm	150-180°
500-750 A	55-80 A	190-300 A	4,8 mm	150-180°
750-1100 A	80-125 A	325-450 A	6,4 mm	150-180°

O eléctrodo deverá ser afiado conforme indica a figura.

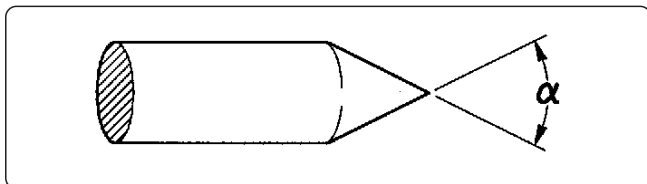

Material de adição

As barras de adição deverão ter características mecânicas semelhantes às do material base.

Não utilizar tiras retiradas do material base, uma vez que estas podem conter impurezas resultantes da manipulação, que poderão afectar negativamente a qualidade da soldadura.

Gás de protecção

Normalmente, é utilizado árgon puro (99,99%).

Limites de corrente			Gas	
(DC-)	(DC+)	(AC)	Bocal	Fluxo
3-20 A	-	3-20 A	n° 4	5-6 l/min
15-80 A	-	20-30 A	n° 5	6-8 l/min
70-150 A	10-20 A	30-80 A	n° 6	7-10 l/min
150-250 A	15-30 A	60-130 A	n° 7	8-12 l/min
250-400 A	25-40 A	100-180 A	n° 8	10-14 l/min
400-500 A	40-55 A	160-240 A	n° 8	12-16 l/min
500-750 A	55-80 A	190-300 A	n° 10	15-20 l/min
750-1100 A	80-125 A	325-450 A	n° 12	20-25 l/min

PT

10. CARACTERÍSTICAS TÉCNICAS

Características eléctricas			U.M.
Tensão de alimentação U1 (50/60 Hz)	3x230 (±15%)	3x400 (±15%)	Vac
Zmax (@PCC) *	53	53	mΩ
Fusível geral atrasado	25	16	A
Bus de comunicação	DIGITALE	DIGITALE	
Potência máxima de entrada	10.5	10.5	kVA
Potência máxima de entrada	10.1	10.1	kW
Potência absorvida em estado de inatividade	51	51	W
Factor de potência (PF)	0.96	0.96	
Eficiência (μ)	83	83	%
Cos φ	0.99	0.99	
Corrente máxima de entrada I1max	30.8	15.3	A
Corrente efectiva I1eff	18	9	A
Gama de regulação	3-270	3-270	A
Tensão em vazio Uo	80	80	Vdc
Tensão de pico Up	10.1	10.1	kV

* Este equipamento cumpre a norma EN / IEC 61000-3-11.

* Este equipamento está em conformidade com a norma EN / IEC 61000-3-12 se a impedância da energia eléctrica máxima permitida no ponto de ligação à rede pública (ponto de acoplamento comum à rede pública (PAC)) for inferior ou igual ao valor "Zmax" fixado. Se estiver ligado a uma rede pública de baixa tensão, compete ao instalador ou utilizador do equipamento garantir a ligação do equipamento, consultando o fornecedor da rede de distribuição, se necessário.

Factor de utilização	3x230V	3x400V	U.M.
Factor de utilização (40°C)			
(X=35%)	270	270	A
(X=60%)	230	230	A
(X=100%)	180	180	A
Factor de utilização (25°C)			
(X=80%)	270	270	A
(X=100%)	240	240	A

Características físicas			U.M.
Grau de protecção IP	IP23S		
Classe de isolamento	H		
Dimensões (lxwxh)	500x190x400		mm
Peso	18.8		Kg
Secção cabo de alimentação.	4x4		mm ²
Comprimento do cabo de alimentação	5		m
Normas de construção	EN IEC 60974-1/A1:2019 EN IEC 60974-3:2019 EN 60974-10/A1:2015		

11. PLACA DE DADOS

VOESTALPINE BÖHLER WELDING SELCO S.R.L. Via Palladio,19 - ONARA (PADOVA) - ITALY					
URANOS NX 2700 TLH			N°		
		EN 60974-1/A1:2019 IEC 60974-10/A1:2015 Class A		60974-3:2019	
Up 10.1 kV 3A/10.0V - 270A (270A)/20.8V (20.8V)					
X (40°C) 35% 60% 100%					
	U ₀ 80V	I _z	270A (270A)	230A (230A)	180A (180A)
		U _z	20.8V (20.8V)	19.2V (19.2V)	17.2V (17.2V)
3A/20.0V - 270A (270A)/30.8V (30.8V)					
X (40°C) 35% 60% 100%					
	U ₀ 80V	I _z	270A (270A)	230A (230A)	180A (180A)
		U _z	30.8V (30.8V)	29.2V (29.2V)	27.2V (27.2V)
U ₁ 400V(230V)		I _{1max} 15.3A(30.8A)		I _{1eff} 9A(18A)	
IP 23 S					
MADE IN ITALY					

12. SIGNIFICADO DA PLACA DE DADOS

1		2			
3			4		
5		6			
7	9	23			
		11			
8	10	12	15	16	17
		13	15A	16A	17A
		14	15B	16B	17B
7	9	11			
		12	15	16	17
8	10	13	15A	16A	17A
		14	15B	16B	17B
		18	19	20	21
22					
MADE IN ITALY					

CE Declaração de conformidade UE
 EAC Declaração de conformidade EAC
 UKCA Declaração de conformidade UKCA

- 1 Marca de fabrico
- 2 Nome e morada do fabricante
- 3 Modelo de equipamento
- 4 N.º de série
- XXXXXXXXXXXXXX Ano de fabrico
- 5 Símbolo do tipo de máquina de soldar
- 6 Referência às normas de fabrico
- 7 Símbolo do processo de soldadura
- 8 Símbolo para máquinas de soldar adequadas para trabalhar em ambiente com risco acrescido de choque elétrico
- 9 Símbolo da corrente de soldadura
- 10 Tensão nominal em vazio
- 11 Gama de corrente nominal máxima e mínima de soldadura e correspondente tensão de carga convencional
- 12 Símbolo do ciclo de intermitência
- 13 Símbolo de corrente nominal de soldadura
- 14 Símbolo de tensão nominal de soldadura
- 15 Valores do ciclo de intermitência
- 16 Valores do ciclo de intermitência
- 17 Valores do ciclo de intermitência
- 15A Valores da corrente nominal de soldadura
- 16A Valores da corrente nominal de soldadura
- 17A Valores da corrente nominal de soldadura
- 15B Valores da tensão convencional de carga
- 16B Valores da tensão convencional de carga
- 17B Valores da tensão convencional de carga
- 18 Símbolo para a alimentação
- 19 Tensão nominal de alimentação
- 20 Corrente nominal máxima de alimentação
- 21 Corrente eficaz máxima de alimentação
- 22 Grau de proteção
- 23 Tensão nominal de pico

PT

EU-CONFORMITEITSVERKLARING

De bouwer

voestalpine Böhler Welding Selco S.r.l. - Via Palladio, 19 - 35019 Onara di Tombolo (PD) - ITALY
Tel. +39 049 9413/111 - Fax +39 049 9413/311 - www.voestalpine.com/welding

verklaart onder eigen verantwoordelijkheid dat het volgende product:

URANOS NX 2700 TLH **55.07.042**
55.07.043

conform is met de normen EU:

2014/35/EU LOW VOLTAGE DIRECTIVE

2014/30/EU EMC DIRECTIVE

2011/65/EU RoHS DIRECTIVE

2019/1784/EU EcoDesign

2009/125/EU EcoDesign

en dat de volgende geharmoniseerde normen zijn toegepast:

EN IEC 60974-1/A1:2019 WELDING POWER SOURCE
EN IEC 60974-3:2019 ARC STRIKING AND STABILIZING DEVICES
EN 60974-10/A1:2015 ELECTROMAGNETIC COMPATIBILITY REQUIREMENTS

De documentatie waaruit blijkt dat aan de richtlijnen wordt voldaan, wordt ter inzage gehouden bij de bovengenoemde fabrikant.

Iedere ingreep of modificatie die niet vooraf door voestalpine Böhler Welding Selco S.r.l. is goedgekeurd maakt dit certificaat ongeldig.

Onara di Tombolo, 01/07/2024

voestalpine Böhler Welding Selco s.r.l.



Mirco Frasson Ivo Bonello

Managing Directors

INHOUDSOPGAVE

1. WAARSCHUWING.....	224
1.1 Gebruiksomgeving.....	224
1.2 Bescherming voor de lasser en anderen.....	224
1.3 Bescherming tegen rook en gassen.....	225
1.4 Brand en explosie preventie.....	226
1.5 Voorzorgmaatregelen voor het gebruik van gasflessen.....	226
1.6 Beveiliging tegen elektrische schokken.....	226
1.7 Elektromagnetische velden en storingen.....	226
1.8 IP Beveiligingsgraad.....	228
1.9 Verwijdering.....	228
2. HET INSTALLEREN.....	228
2.1 Procedure voor het laden, vervoeren en lossen.....	228
2.2 Plaatsen van de installatie.....	228
2.3 Aansluiting.....	228
2.4 Installeren.....	229
3. PRESENTATIE VAN DE INSTALLATIE.....	230
3.1 Achter paneel.....	230
3.2 Paneel met contactpunten.....	230
3.3 Bedieningspaneel vooraan.....	231
4. GEBRUIK VAN APPARATUUR.....	232
4.1 Start scherm.....	232
4.2 Hoofd scherm.....	232
4.3 Hoofdscherm MMA-proces.....	232
5. SETUP.....	236
5.1 Set up en instelling van de parameters.....	236
5.2 Specifieke gebruiksprocedures van de parameters.....	243
6. ONDERHOUD.....	247
6.1 Controleer de stroombron regelmatig als volgt.....	247
6.2 Odpovědnost.....	247
7. ALARM CODES.....	248
8. MEEST VOORKOMENDE VRAGEN EN OPLOSSINGEN.....	250
9. BEDIENINGSINSTRUCTIES.....	253
9.1 Handleiding lassen met beklede elektroden (MMA).....	253
9.2 TIG-Lassen met ononderbroken vlamboog.....	254
10. TECHNISCHE KENMERKEN.....	256
11. GEGEVENSPLAAT.....	257
12. BETEKENIS GEGEVENSPLAATJE.....	257
13. SCHEMA.....	438
14. VERBINDINGEN.....	440
15. LIJST VAN RESERVE ONDERDELEN.....	441

SYMBOLLEN



Waarschuwing



Verboden



Verplichtingen



Algemene indicaties

1. WAARSCHUWING



Voor het gebruik van de machine dient u zich ervan te overtuigen dat u de handleiding goed heeft gelezen en begrepen.

Breng geen veranderingen aan en voer geen onderhoudswerkzaamheden uit die niet in deze handleiding vermeld staan. De fabrikant kan niet verantwoordelijk worden gehouden voor lichamelijke schade of schade aan eigendommen die zijn veroorzaakt door verkeerd gebruik van de machine of het onjuist interpreteren van de handleiding.

Bewaar de gebruiksaanwijzing altijd op de plaats waar het apparaat wordt gebruikt. Naast de gebruiksaanwijzing dienen ook de algemene regels en plaatselijke voorschriften ter voorkoming van ongevallen en ter bescherming van het milieu in acht te worden genomen.

Voestalpine Böhler Welding Selco s.r.l. behoudt zich het recht voor deze handleiding te allen tijde te kunnen wijzigen zonder voorafgaande aankondiging.

Het is verboden zonder voorafgaande schriftelijke toestemming van **Voestalpine Böhler Welding Selco s.r.l.** deze handleiding te vertalen of geheel of gedeeltelijk te kopiëren (hierbij inbegrepen zijn fotokopieën, film of microfilm). Deze richtlijnen zijn van vitaal belang en dienen strikt te worden opgevolgd om aanspraak te kunnen maken op garantie.

De fabrikant accepteert geen enkele aansprakelijkheid als de gebruiker zich niet heeft gehouden aan deze richtlijnen.



Ledereen die met de inbedrijfstelling, het gebruik, het onderhoud en de reparatie van het apparaat is belast moet:

- in het bezit zijn van een passende kwalificatie
- over de nodige lasvaardigheden beschikken
- deze gebruiksaanwijzing volledig doorlezen en strikt naleven

In geval van twijfel of problemen bij het gebruik, zelfs als het niet staat vermeldt, raadpleeg uw leverancier.

1.1 Gebruiksomgeving



Iedere machine mag alleen worden gebruikt voor de werkzaamheden waarvoor hij is ontworpen, op de manier zoals is voorschreven op de gegevensplaat en/of deze handleiding, in overeenstemming met de nationale en internationale veiligheidsvoorschriften. Oneigenlijk gebruik zal worden gezien als absoluut ongepast en gevaarlijk en in een dergelijk geval zal de fabrikant iedere verantwoordelijkheid afwijzen.



Deze apparatuur dient uitsluitend voor professionele doeleinde te worden gebruikt in een industriële omgeving. De fabrikant kan niet aansprakelijk worden gesteld voor schade veroorzaakt door gebruik van de apparatuur in een huishoudelijke omgeving.



De omgevingstemperatuur voor gebruik van de machine moet liggen tussen -10° C en +40° C (Tussen +14°F en +104°F).

Voor transport en opslag moet de temperatuur liggen tussen -25°C en +55°C (tussen -13°F en +131°F).

De machine moet worden gebruikt in een stofvrije omgeving zonder zuren, gas of andere corrosieve stoffen.

De vochtigheidsgraad van de werkomgeving van de machine mag niet hoger zijn dan 50% bij 40°C (104°F).

De vochtigheidsgraad van de werkomgeving van de machine mag niet hoger zijn dan 90% bij 20°C (68°F).

De machine kan worden gebruikt tot op een hoogte van 2000 meter boven de zeespiegel (6500 voet).



Gebruik de machine niet om pijpen te ontdoeien.

Gebruik de machine niet om batterijen en/of accu's op te laden.

Gebruik de machine niet om motoren mee te starten.

1.2 Bescherming voor de lasser en anderen



Bij het lasproces en ontstaan schadelijke stoffen zoals straling, lawaai, hitte en gasuitstoot. Plaats een vuurvast scherm om het lasgebied ter bescherming tegen straling, vonken en gloeiend afval. Adviseer iedereen in de nabijheid niet rechtstreeks in de lasboog of het gloeiende metaal te kijken en om een laskap te gebruiken.



Draag beschermende kleding om uw huid te beschermen tegen straling vonken en gloeiende metaalsplinters. De kleding moet het gehele lichaam bedekken:

- heel en van goede kwaliteit zijn
- vuurvast
- isolerend en droog
- goed passend en zonder manchetten en omslagen



Draag altijd goed, stevig waterdicht schoeisel.



Draag altijd goede hitte- en stroombestendige handschoenen.



Draag een laskap met zijflappen en met een geschikte lasruit (minimale sterkte nr. 10 of hoger) voor de ogen.



Draag altijd een veiligheidsbril met zijbescherming vooral tijdens het handmatig of mechanisch verwijderen van lasafval.



Draag geen contactlenzen!



Gebruik gehoorbescherming als tijdens het lassen het geluidsniveau te hoog wordt. Als het geluidsniveau de wettelijk vastgestelde waarde overschrijdt moet de werkplek worden afgeschermd en moet iedereen die in de nabijheid komt gehoorbescherming dragen.



Laat de zijpanelen tijdens het lassen altijd gesloten. De installatie mag op geen enkele manier worden gewijzigd.



Raak zojuist gelaste voorwerpen niet aan, de grote hitte kan brandwonden veroorzaken.



Volg alle veiligheidsvoorschriften op, ook tijdens bewerkingen na het lassen. Er kunnen tijdens het afkoelen van het werkstuk nog slakken loslaten.



Controleer vooraf of de toorts koud is voor u begint met lassen of met onderhoud begint.



Overtuig u ervan dat de koelunit is uitgeschakeld voordat u de leidingen van de koelvloeistof losmaakt. De hete vloeistof uit de leidingen kan ernstige brandwonden veroorzaken.



Houd een verbanddoos binnen handbereik.
Onderschat brandwonden of andere verwondingen nooit.



Overtuigt u er voor dat u vertrekt van dat de werkplek goed is opgeruimd, zo voorkomt u ongevallen.

1.3 Bescherming tegen rook en gassen



Rook, gassen en stoffen die tijdens het lassen vrijkomen, kunnen gevaarlijk zijn voor de gezondheid. Onder bepaalde omstandigheden kan de lasrook kanker veroorzaken en bij zwangerschap de foetus schaden.

- Houdt u hoofd ver van de lasrook en gassen.
- Zorg voor goede ventilatie, natuurlijke of mechanische, op de werkplek.
- Gebruik bij slechte ventilatie maskers of verse lucht helmen.
- Bij het lassen in extreem kleine ruimten verdient het aanbeveling de lasser door een collega buiten de ruimte scherp in de gaten te laten houden.
- Gebruik geen zuurstof om te ventileren.
- Controleer of de afzuiging goed werkt door regelmatig na te gaan of schadelijke gassen in de luchtmonsters onder de norm blijven.
- De hoeveelheid en de mate van gevaar van de rook hangt af van het materiaal dat gelast wordt, het lasmateriaal en het schoonmaakmiddel dat is gebruikt om het werkstuk schoon en vetvrij te maken. Volg de aanwijzingen van de fabrikant en de bijgeleverde technische gegevens.
- Las niet direct naast plaatsen waar ontvet of geveerd wordt.
- Plaats gasflessen buiten of in goed geventileerde ruimten.

1.4 Brand en explosie preventie



Het las proces kan brand en/of explosies veroorzaken.

- Verwijder alle brandbare en lichtontvlambare producten van de werkplek en omgeving.
- Brandbare materialen moeten minstens op 11 meter (35 voet) van de lasplaats worden opgeslagen of ze moeten goed afgeschermd zijn.
- Vonken en gloeiende deeltjes kunnen makkelijk ver weg springen, zelfs door kleine openingen. Geef veel aandacht aan de veiligheid van mens en werkplaats.
- Las nooit boven of bij containers die onder druk staan.
- Las nooit in gesloten containers of buizen. Resten van gas, brandstof, olie of soortgelijke stoffen kunnen explosies veroorzaken.
- Las niet op plaatsen waar explosieve stoffen, gassen of dampen zijn.
- Controleer na het lassen of de stroomtoevoer niet per ongeluk contact maakt met de aardkabel.
- Installeer brandblusapparatuur in de omgeving van de werkplek.

1.5 Voorzorgmaatregelen voor het gebruik van gasflessen



Gasflessen zijn onder druk gevuld en kunnen exploderen als de veiligheidsvoorschriften niet in worden nageleefd bij vervoer, opslag en gebruik.

- De flessen moeten rechtop verankerd staan aan een muur of een andere stevige constructie zodat ze niet per ongeluk kunnen omvallen of tegen iets aanstoten.
- Draai de beschermdop van het ventiel goed vast tijdens transport, bij het aansluiten en bij het lassen.
- Stel de flessen niet bloot aan direct zonlicht of grote temperatuurschommelingen. Stel de flessen niet bloot aan extreme koude of hoge temperaturen.
- Laat de gasflessen niet in aanraking komen met open vuur, elektrische stroom, lastoortsen of elektrische klemmen of met wegspringende vonken en splinters.
- Houdt de gasflessen altijd uit de buurt van las- en stroomcircuits.
- Draai uw gezicht af wanneer u het ventiel van de gasfles open draait.
- Draai het ventiel van de gasfles na het werk altijd dicht.
- Las nooit aan gasflessen die onder druk staan.
- Een persluchtfles onder druk mag nooit direct gekoppeld worden aan het reduceerventiel van de lasmachine. De druk zou hoger kunnen zijn dan het vermogen van het reduceerventiel waardoor hij zou kunnen exploderen.

1.6 Beveiliging tegen elektrische schokken



Elektrische schokken kunnen dodelijk zijn.

- Vermijd het aanraken van spanningvoerende delen binnen of buiten de lasapparatuur terwijl de apparatuur zelf onder spanning staat (toortsen, klemmen, massakabels, elektroden, draden, haspels en spoelen zijn elektrisch verbonden met het lascircuit).
- Zorg voor elektrische isolatie van het systeem en de bediener door droge vloeren en ondergronden te gebruiken die voldoende geïsoleerd zijn van het massa- en aardingspotentialaal.
- Overtuigt u ervan dat de machine goed is aangesloten aan de contactdoos en dat de krachtbron voorzien is van een aardkabel.
- Raak nooit twee toortsen of elektrodehouders tegelijk aan.
- Stop direct met lassen als u een elektrische schok voelt.



Het instrument om de boog te ontsteken en te stabiliseren is ontworpen voor handmatig of mechanisch gestuurd gebruik.



Door de lengte van de toorts of de laskabels met meer dan 8 m te vergroten zal het risico op een elektrische schok verhogen.

1.7 Elektromagnetische velden en storingen



De stroom die intern en extern door de kabels van de machine gaat veroorzaakt een elektromagnetisch veld rondom de kabels en de machine.

- Deze elektromagnetische velden zouden een negatief effect kunnen hebben op mensen die er langere tijd aan bloot gesteld zijn. (de juiste effecten zijn nog onbekend).
- Elektromagnetische velden kunnen storingen veroorzaken bij hulpmiddelen zoals pacemakers en gehoorapparaten.



Personen die een pacemaker hebben moeten eerst hun arts raadplegen voor zij las- of plasma snij werkzaamheden gaan uitoefenen.

1.7.1 EMC classificatie in overeenstemming met: EN 60974-10/A1:2015.

Klasse B

Klasse B apparatuur voldoet aan de elektromagnetische eisen van aansluiting zowel wat betreft de industriële omgeving als de woonomgeving, inclusief de woonomgeving waar de stroomvoorziening wordt betrokken van het netwerk en dus met een lage spanning.

Klasse A

Klasse A apparatuur is niet bedoeld om te gebruiken in de woonomgeving waar de stroom geleverd wordt via het normale netwerk met lage spanning. In een dergelijke omgeving kunnen zich potentiële moeilijkheden voordoen bij het veilig stellen van de elektromagnetische aansluiting van klasse A apparatuur veroorzaakt door geleiding of storing door straling.

Zie voor meer informatie: GEGEVENSPLAAT of TECHNISCHE KENMERKEN.

1.7.2 Installatie, gebruik en evaluatie van de werkplek

Deze apparatuur is gebouwd volgens de aanwijzingen in de geharmoniseerde norm EN 60974-10/A1:2015 en wordt gerekend tot de Klasse A. Deze apparatuur dient uitsluitend voor professionele doeleinde te worden gebruikt in een industriële omgeving. De fabrikant kan niet aansprakelijk worden gesteld voor schade veroorzaakt door gebruik van de apparatuur in een huishoudelijke omgeving.



De gebruiker moet een vakkundig iemand zijn die zich verantwoordelijk voelt voor de apparatuur en er gebruik van maakt volgens de richtlijnen van de fabrikant. Wanneer zich elektromagnetische storingen voordoen moet de lasser de problemen oplossen zondig met de technische assistentie van de fabrikant.



In ieder geval dient de elektromagnetische storing zodanig gereduceerd te worden dat het geen hinder meer vormt.



Voor de installatie dient de gebruiker de risico's te evalueren die elektromagnetische storingen zouden kunnen opleveren voor de directe omgeving, hierbij in het bijzonder lettend op de gezondheidsrisico's voor personen op en in de omgeving van de werkplek, bij voorbeeld mensen die een pacemaker of een gehoorapparaat hebben.

1.7.3 Eisen voor het leidingnet

Apparatuur op hoogspanning kan, ten gevolge van de eerste stroom die wordt betrokken van het gewone netwerk, de kwaliteit beïnvloeden van de stroom van het hoogspanningsnet. Daarom zijn aansluitingsbeperkingen of eisen ten aanzien van de maximaal toelaatbare stroomsterkte van wisselstroom (Z_{max}) of de noodzakelijke minimale toevoer (S_{sc}) capaciteit op de interface van het normale hoogspanning netwerk (punt van normale koppeling, PCC) kan van toepassing zijn bij sommige typen apparatuur. (zie de technische informatie). In dat geval is het de verantwoordelijkheid van de installateur of van de gebruiker van de apparatuur om zich ervan te vergewissen, zondig door de netwerkbeheerder te raadplegen, dat de apparatuur mag worden aangesloten. In het geval er storingen optreden kan het aanbeveling verdienen om verdere voorzorgmaatregelen te nemen zoals het filteren van de stroomtoevoer.

Het is ook noodzakelijk om de mogelijkheid te overwegen de stroomkabel af te schermen.

Zie voor meer informatie: TECHNISCHE KENMERKEN.

1.7.4 Voorzorgmaatregelen voor kabels

Om de effecten van de elektromagnetische velden zo klein mogelijk te houden dient u de hieronder staande richtlijnen te volgen:

- Houdt de laskabel en de aardkabel zoveel mogelijk bij elkaar opgerold.
- Vermijdt dat de kabels rond uw lichaam draaien.
- Vermijdt dat u tussen de aard- en de laskabel in staat, (houdt beide aan één kant).
- De kabels moeten zo kort mogelijk gehouden worden, bij elkaar gehouden op of zo dicht mogelijk bij de grond.
- Plaats de apparatuur op enige afstand van de werkplek.
- Houdt de kabels ver verwijderd van andere kabels.

1.7.5 Geaarde verbinding van de installatie

Het wordt aanbevolen alle verbindingen van alle metalen onderdelen in de las machine en in de omgeving ervan te aarden. Deze verbindingen dienen te zijn gemaakt volgens de plaatselijk geldende veiligheids regels.

1.7.6 Het werkstuk aarden

Wanneer het werkstuk niet geaard is vanwege elektrische veiligheid, de afmeting of de plaats waar het staat kan het aarden van het werkstuk de straling verminderen. Het is belangrijk er aan te denken dat het aarden van het werkstuk zowel het gevaar voor de lasser op ongelukken als schade aan andere apparatuur niet mag vergroten. Het aarden moet volgens de plaatselijke veiligheidsvoorschriften gebeuren.

1.7.7 Afscherming

Door het selectief afschermen van andere kabels en apparatuur in de directe omgeving kunnen de storingsproblemen afnemen.

Bij speciale toepassingen kan het worden overwogen de gehele lasplaats af te schermen.

1.8 IP Beveiligingsgraad



IP23S

- De kast voorkomt dat gevaarlijke onderdelen met de vingers of voorwerpen met een diameter tot 12.5mm kunnen worden aangeraakt.
- De kast beschermt tegen inregenen tot een hoek van 60° in verticale stand.
- De kast beschermt tegen de gevolgen van binnen druppelend water als de machine niet aanstaat.

1.9 Verwijdering



Verwijder elektrische apparatuur niet bij het normale afval!

In overeenstemming met de Europese Richtlijn 2012/19/EU betreffende afgedankte elektrische en elektronische apparatuur en de uitvoering daarvan in overeenstemming met de nationale wetgevingen, moet elektrische apparatuur die het einde van haar levenscyclus heeft bereikt, gescheiden worden ingezameld en naar een centrum voor nuttige toepassing en verwijdering worden gebracht. De eigenaar van de apparatuur dient bij de plaatselijke autoriteiten te informeren naar de erkende inzamelpunten. Door toepassing van de Europese richtlijn kunnen het milieu en de menselijke gezondheid worden verbeterd.

» Raadpleeg de website voor meer informatie.

2. HET INSTALLEREN



Het installeren dient te worden gedaan door vakkundig personeel met instemming van de fabrikant.



Overtuigt u ervan dat de stroom is uitgeschakeld voordat u gaat installeren.



Het is verboden om stroombronnen in serie of in parallel te schakelen.

2.1 Procedure voor het laden, vervoeren en lossen

- De machine is uitgerust met een handgreep voor transport.



Onderschat het gewicht van de apparatuur niet, zie de technische specificatie. Beweeg of hang het apparaat nooit boven personen of voorwerpen. Laat het apparaat niet vallen of botsen.

2.2 Plaatsen van de installatie



Houdt u aan onderstaande regels:

- Zorg ervoor dat de installatie en de aansluitingen goed toegankelijk zijn.
- Plaats het apparaat niet in een te kleine ruimte.
- Plaats het apparaat niet op een schuin aflopende ondergrond van meer dan 10° waterpas.
- Plaats het apparaat in een droge, schone en goed geventileerde ruimte.
- Bescherm het apparaat tegen hevige regen en tegen de zon.

2.3 Aansluiting



De stroombron is voorzien van een primaire stroomkabel voor de aansluiting op het lichtnet.

De installatie kan worden gevoed door:

- 230 V drie fase
- 400 V drie fase

De werking van het apparaat wordt gegarandeerd voor spanningswaarden tot $\pm 15\%$ ten opzichte van de nominale waarde.



Om lichamelijk letsel en schade aan de apparatuur te voorkomen moet u de geselecteerde netspanning en de zekeringen controleren voor u de machine op het net aansluit. Controleer ook of het stopcontact geard is.



De machine kan gevoed worden door een stroomaggregaat als deze een stabiele voedingsspanning garandeert van $\pm 15\%$ van de door de fabrikant voorgeschreven nominale behoefte, zodat onder alle werkomstandigheden en met maximale capaciteit gelast kan worden. Wij adviseren bij één fase lasapparaat een stroomaggregaat te gebruiken die tweemaal het vermogen van de stroombron geeft, in geval van drie fase lasapparaat is dit 1½. Het gebruik van een stroomaggregaat met elektrische bediening wordt aangeraden.



Ter bescherming van de gebruikers moet de installatie goed geaard zijn. De stroom kabel is voorzien van een aarde kabel (geel-groen), en moet worden verbonden met een geaarde stekker. Deze geel/groene draad mag nooit worden gebruikt met andere stroomdraden. Controleer de aardverbinding op de werkplek en of de stopcontacten in goede staat verkeren. Installeer alleen stekkers die voldoen aan de veiligheid eisen.



Het elektrische systeem moet worden aangesloten door vakkundig technisch personeel met de juiste kwalificaties en volgens de nationale veiligheids normen.

2.4 Installeren

2.4.1 Aansluiting voor het MMA lassen



De aansluiting zoals u die ziet op de afbeelding is de algemene situatie bij MMA lassen, d.w.z. de electrodehouder is verbonden met de plus poolen de aardklem met de min pool.

Wilt u lassen met een omgekeerde polariteit dan dient u de te verwisselen, sommige electrode vragen hierom.

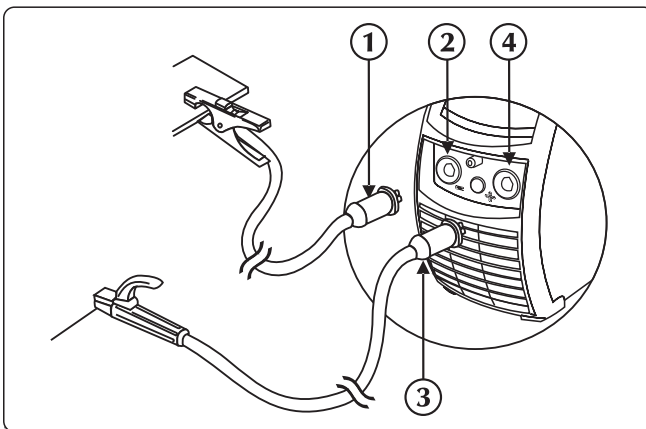



- ① Connector voor aardingsklem
- ② Negatief contactpunt (-)
- ③ Connector voor elektrodehouder
- ④ Positief contactpunt (+)

- ▶ Verbind de aardklem aan de negatieve snelkoppeling (-) van de stroombron. Plaats de stekker en draai met de klok mee tot hij stevig vast zit.
- ▶ Verbind de elektrodehouder aan de positieve snelkoppeling (+) van de stroombron. Plaats de stekker en draai met de klok mee tot hij stevig vast zit.

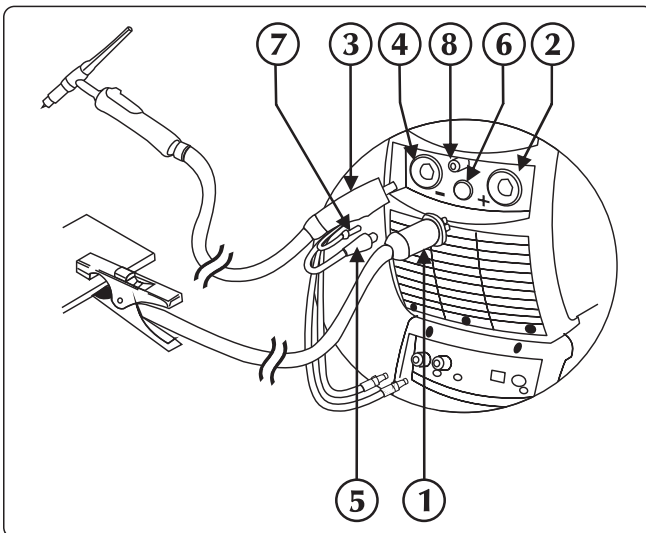
2.4.2 Aansluiting voor het TIG lassen



- ① Connector voor aardingsklem
- ② Positief contactpunt (+)
- ③ TIG toorts aansluiting
- ④ Zaklamp aansluiting
- ⑤ Signaalkabel toorts
- ⑥ Verbinding
- ⑦ Toorts gasbuis
- ⑧ Gasaansluitkoppeling

- ▶ Verbind de aardklem aan de positieve snelkoppeling (+) van de stroombron. Plaats de stekker en draai met de klok mee tot hij stevig vast zit.
- ▶ Verbind de TIG toorts koppeling aan de snelkoppeling (-) van de stroombron. Plaats de stekker en draai met de klok mee tot hij stevig vast zit.
- ▶ Verbind de laskabel van de toorts met de juiste aansluitingklem.
- ▶ Verbind de gasslang van de toorts aan het juiste aansluitpunt.
- ▶ Verbindt de slang voor koelvloeistof (kleur rood) van de toorts met de snelkoppeling (kleur rood - symbool ) van de koelunit.
- ▶ Verbindt de slang voor koelvloeistof (kleur blauw) van de toorts met de snelkoppeling (kleur blauw - symbool ) van de koelunit.

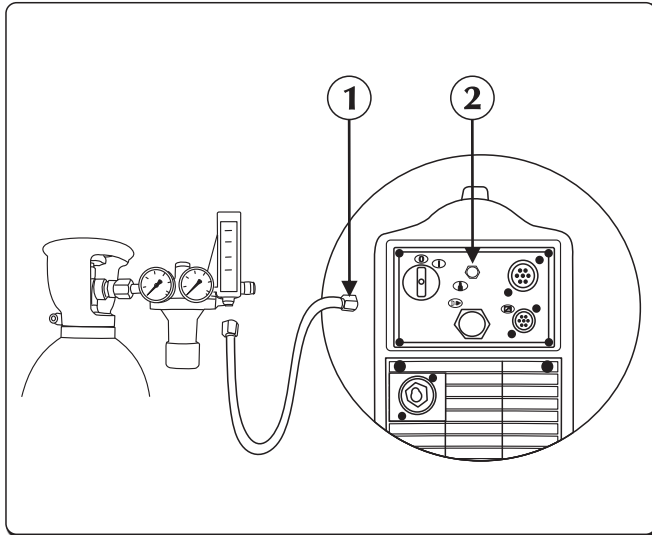

- ① Gasbuis
- ② Gasaansluitkoppeling

► Verbindt de gasleiding van de gasfles aan de gas aansluiting aan de achterkant. Stel de gasstroom in van 5 tot 15 l/min.

3. PRESENTATIE VAN DE INSTALLATIE

3.1 Achter paneel

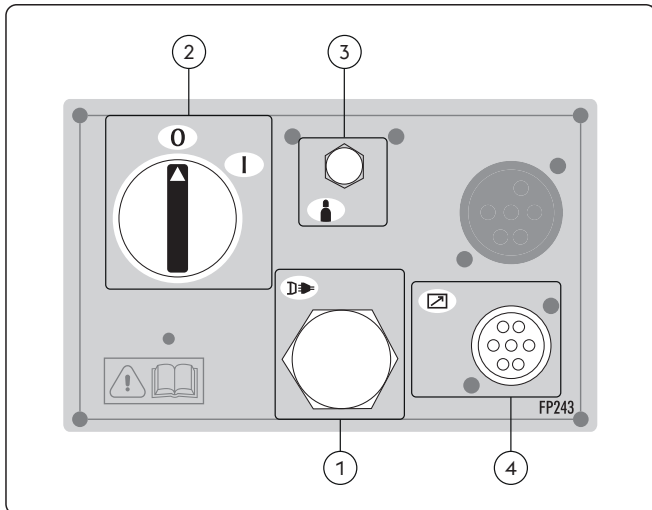

- ① Elektrische kabel
Verbindt de machine met het stroomnet.
- ② An/uit schakelaar
Voor de elektrische inschakeling van het systeem.
De schakelaar heeft 2 standen: "0" uit, "I" aan.
- ③ Gas aansluiting
- ④ Signaalkabel CAN-BUS ingang (RC, RI...)

3.2 Paneel met contactpunten

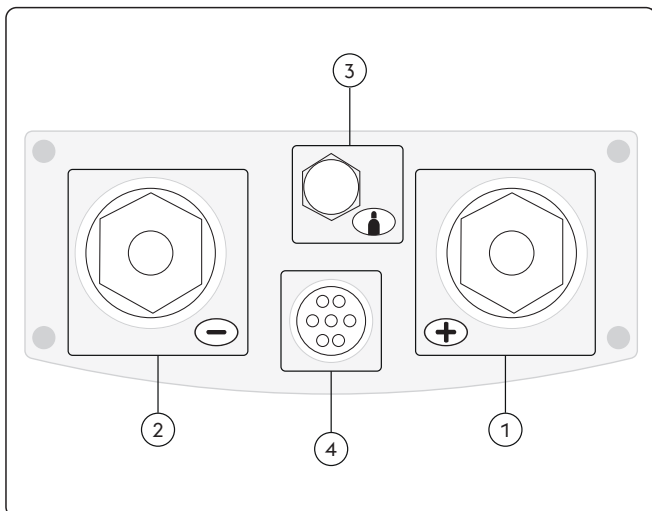

- ① Positief contactpunt (+)
Proces MMA: Aansluiting elektrode toorts
Proces TIG: Aansluiting aardingskabel
- ② Negatief contactpunt (-)
Proces MMA: Aansluiting aardingskabel
Proces TIG: Toorts aansluiting
- ③ Gas aansluiting
- ④ Ingang signaalkabel (TIG-toorts)

NL

3.3 Bedieningspaneel vooraan

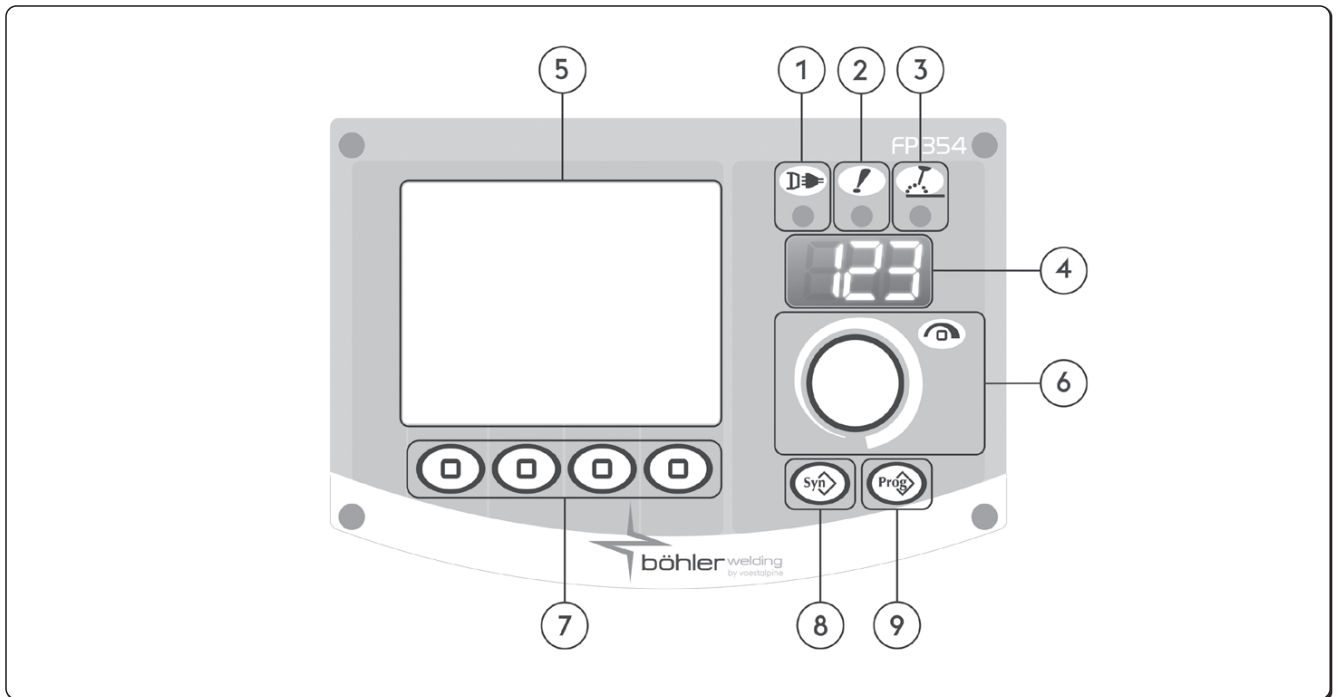

- ①  **Voedingsled**
Geeft aan dat de stroom is ingeschakeld en de machine aan staat.
- ②  **Algemeen alarm-led**
Geeft aan dat het beveiligingssysteem een mogelijke storing constateert zoals bij voorbeeld bij een te hoge temperatuur.
- ③  **Actief vermogen-led**
Geeft aan dat de boogspanning is geactiveer.
- ④  **7-segmenten display**
Zorgt ervoor dat u de waarden van de parameters kunt aflezen tijdens het opstarten van de machine, de instellingen, de stroomtoevoer en de voltage tijdens het lassen, en de alarm codes.
- ⑤  **LCD display**
Zorgt ervoor dat u de waarden van de parameters kunt aflezen tijdens het opstarten van de machine, de instellingen, de stroomtoevoer en de voltage tijdens het lassen, en de alarm codes.
Maakt het mogelijk dat alle handelingen direct getoond worden.
- ⑥  **Belangrijkste instellingsknop**
Zorgt ervoor dat de las stroom doorlopend kan worden aangepast.
Staat het opstarten toe. De keuze en de instelling van de las parameters.
- ⑦  **Functietoetsen**
Hiermee kunnen de verschillende functies van de installatie geïnstalleerd worden:
- Las-proces
- Las methodes
- Pulserende stroom
- Grafische modus
- ⑧  **Toets niet in gebruik**
- ⑨  **Toets job**
Maakt het opslaan en besturen mogelijk van 240 las job die door de lasser gepersonifieerd zijn.

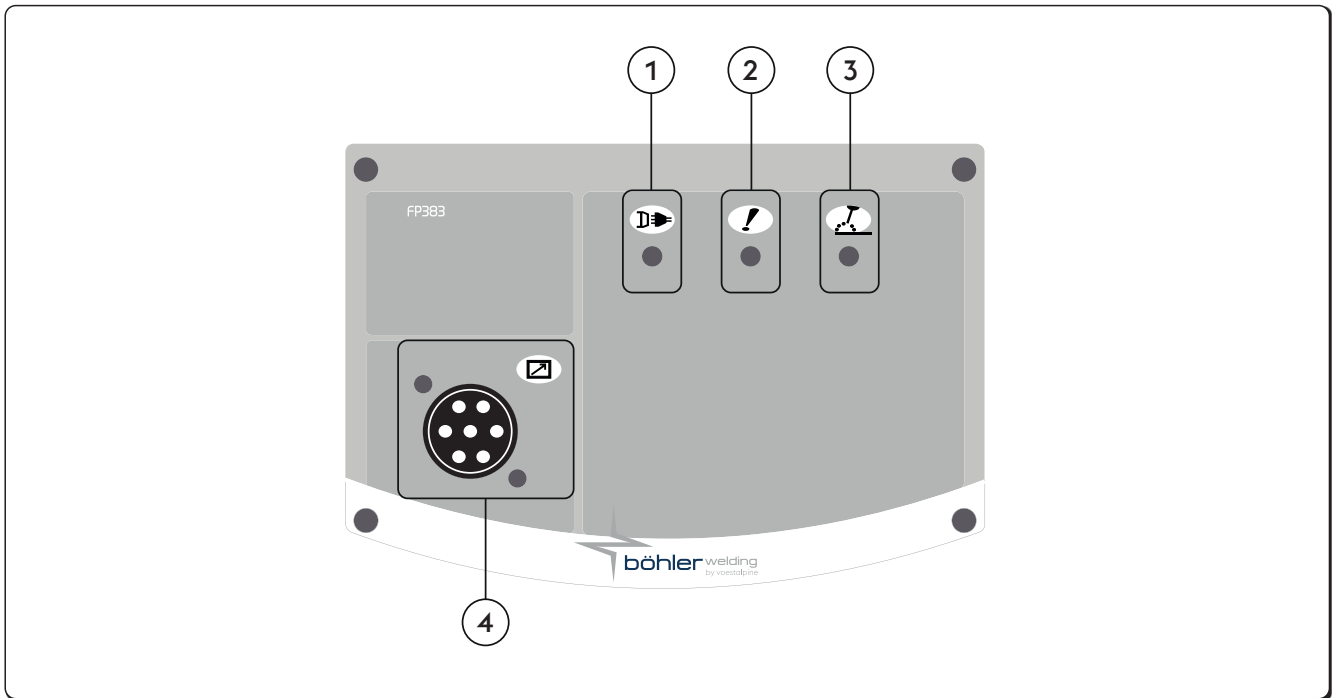

- ① **Voedingsled**
Geeft aan dat de stroom is ingeschakeld en de machine aan staat.
- ② **Algemeen alarm-led**
Geeft aan dat het beveiligingssysteem een mogelijke storing constateert zoals bij voorbeeld bij een te hoge temperatuur.
- ③ **Actief vermogen-led**
Geeft aan dat de boogspanning is geactiveer.
- ④ **Signaalkabel CAN-BUS ingang (RC, RI...)**

4. GEBRUIK VAN APPARATUUR

4.1 Start scherm

Bij inschakeling voert het systeem een aantal controles uit om de correcte werking ervan te garanderen, met inbegrip van alle aangesloten apparaten. In dit stadium wordt de gas test ook uitgevoerd om de juiste aansluiting te controleren van het gastoevoer systeem.

4.2 Hoofd scherm

Maakt de controle mogelijk van het systeem en het las proces en laat de hoofd instellingen zien.

4.3 Hoofdscherm MMA-proces

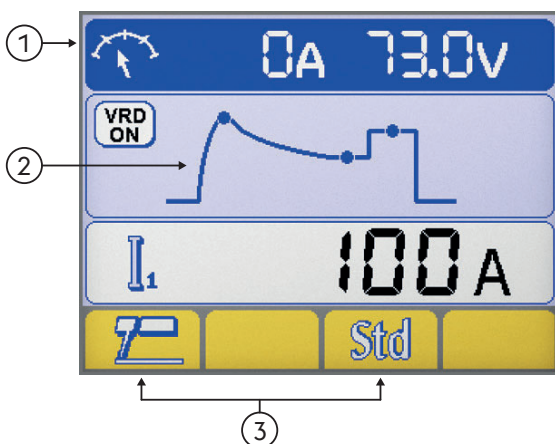

- ① Spanning en stroom
- ② Las parameters
- ③ Functies

Spanning en stroom

Tijdens het lasproces worden het werkelijke stroom verbruik en het voltage getoond op het LCD display.

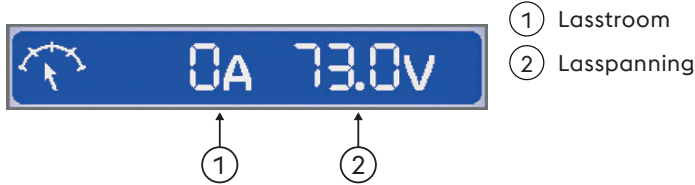

Las parameters

► Selecteer de gewenste parameter door de codeerknop in te drukken.

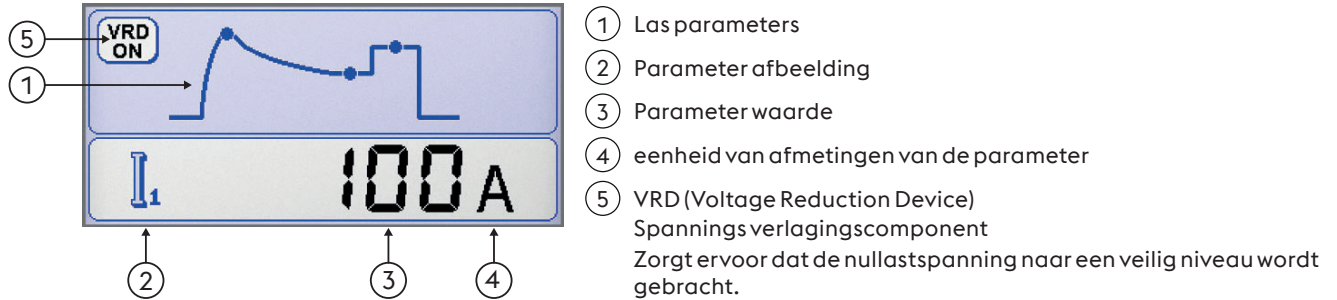

Functies

Maakt het mogelijk de belangrijkste proces functies en las methoden in te stellen.

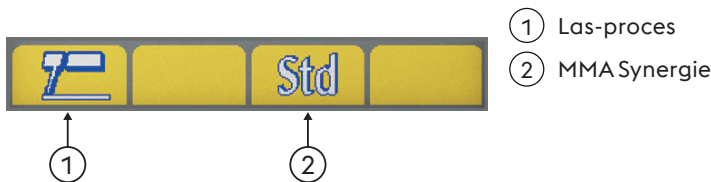

Las-proces



MMA



TIG DC

MMA Synergie



Hiermee kan de beste boogdynamiek worden ingesteld door het selecteren van het type elektrode dat u gaat gebruiken.

Het kiezen van de juiste dynamische boog maakt het mogelijk om het maximaal profijt uit de stroombron te halen zodat de best mogelijk las prestatie wordt behaald.



Standard

(Basisch/Rutiel)



Cellulose



Staal



Aluminium



Gietijzer



Perfekte lasbaarheid van de gebruikte elektrode wordt niet gegarandeerd.

De lasbaarheid is afhankelijk van de kwaliteit en de staat waarin het artikel verkeerd, de werk- en lascondities, en vele mogelijke toepassingen, enz.

4.4 Hoofdscherm TIG-proces

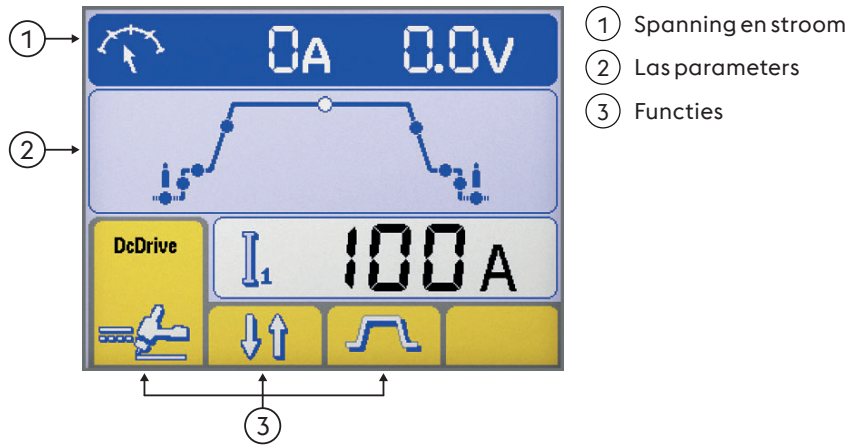

Spanning en stroom

Tijdens het lasproces worden het werkelijke stroom verbruik en het voltage getoond op het LCD display.

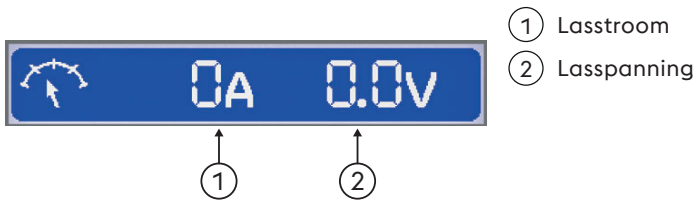

Las parameters

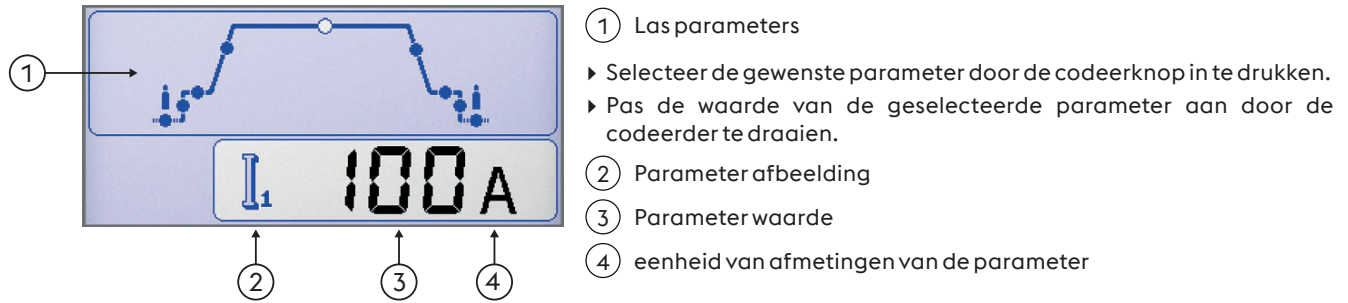

Funcities

Maakt het mogelijk de belangrijkste proces functies en las methoden in te stellen.

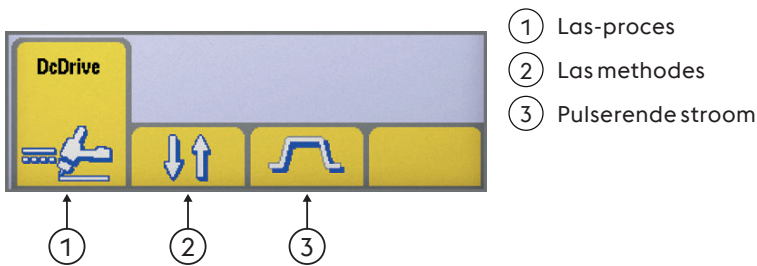

Las-proces



Las methodes

Maakt de keuze mogelijk van de las methode



2 Fasen

In twee fasen, de knop indrukken activeert voor de gastoevoer en zet de boog in werking; als de knop wordt losgelaten loopt de druk terug naar nul, als de boog eenmaal uit is stagneert de gastoevoer.

NL



4 Fasen

In vier fasen, de eerste druk op de knop zorgt ervoor dat de gastoevoer wordt geactiveerd, zodoende een handmatige vooraf gas instelling, en zet de boog inwerking als u de knop loslaat.



Bilevel

Op 'bilevel' kan de lasser met twee verschillende vooraf ingestelde stroomwaarden lassen. De eerste indruk van de knop lijdt naar een voor gas tijd, het aanslaan van de boog en het lassen met de eerste stroom. De eerste afgifte lijdt tot een aflopende stroom "L1". Als de lasser de knop snel indrukt en loslaat volgt er een omschakeling naar "L2". De knop opnieuw snel indrukken en loslaten zorgt weer voor omschakeling naar "L1" enzovoort. Als de knop langer ingedrukt gehouden wordt daalt de stroom naar de eindstroom. Door het loslaten van de knop dooft de boog terwijl het gas doorstroomt voor de na-gas tijd.



Pulserende stroom



Constante boog



Pulserende stroom



Fast Pulse



EasyArc

4.5 Programma's scherm



Maakt het opslaan en besturen mogelijk van 240 las job die door de lasser gepersonifieerd zijn.

Programma's (JOB)

Raadpleeg de paragraaf "Hoofdscherm"

Programma opslaan

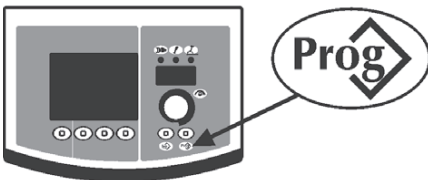

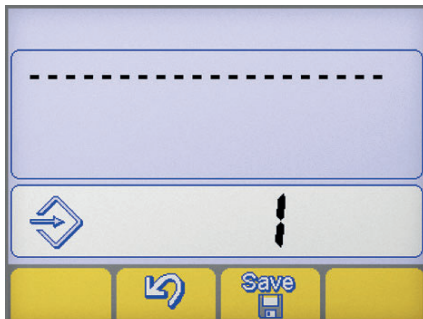

- ▶ Start het menu "programma opslaan" door de knop.  ten minste een seconde ingedrukt te houden.



- ▶ Selecteer het gewenste programma (of het lege geheugen) door de decoder te draaien.



--- Geheugen leeg

 Programma opgeslagen

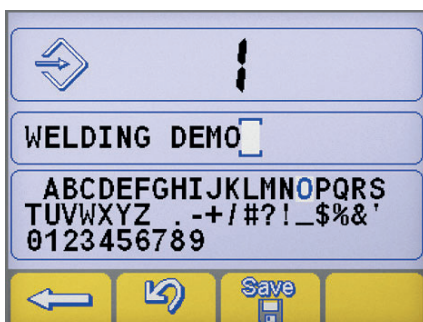
- ▶ Bevestig de handeling door de knop in te drukken .
- ▶ Bewaar alle huidige instellingen van het geselecteerde programma door de knop in te drukken. .



Introduceer een beschrijving van het programma.

- ▶ Selecteer de gewenste letter door de decoder te draaien.
- ▶ Sla de geselecteerde letter op door de decoder in te drukken.
- ▶ Maak de laatste opdracht ongedaan door de knop in te drukken. .
- ▶ Bevestig de handeling door de knop in te drukken .
- ▶ Bevestig de handeling door de knop in te drukken .



Het opslaan van een nieuw programma in een reeds vol geheugen maakt het noodzakelijk het geheugen te wissen op de voorgeschreven manier.



- ▶ Bevestig de handeling door de knop in te drukken
- ▶ Wis het geselecteerde programma door de knop in te drukken.
- ▶ Hervat de procedure opslaan.

Programma ontsluiten

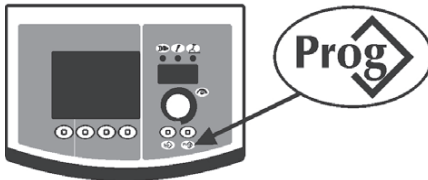

- ▶ Haal het 1e beschikbare programma terug door de knop in te drukken
- ▶ Selecteer het gewenste programma door de decoder te draaien.
- ▶ Selecteer het gewenste programma door de knop in te drukken.
- Alleen de werkprogramma's in het geheugen worden getoond, de programma's die niet in gebruik zijn worden automatisch overgeslagen.

Programma opheffen



- ▶ Selecteer het gewenste programma door de decoder te draaien.
- ▶ Wis het geselecteerde programma door de knop in te drukken.
- ▶ Bevestig de handeling door de knop in te drukken



- ▶ Bevestig de handeling door de knop in te drukken
- ▶ Wis het geselecteerde programma door de knop in te drukken.

NL

5. SETUP

5.1 Set up en instelling van de parameters

Zorgt voor het instellen en regelen van een serie extra parameters voor een betere en meer nauwkeurige controle van het lasstelsel.

De instelling van de parameters is afhankelijk van het geselecteerde lasproces en hebben een numerieke codering.

Beginnen met de set up





- ▶ Door de encoder-toets 5 seconden in te drukken.
- ▶ De toegang wordt bevestigd door de aanduiding 0 op het display.

Selectie en instelling van de gewenste parameters

- ▶ Draai de codeerknop totdat de numerieke code voor de parameter weergegeven wordt.
- ▶ Als de codeerknop op dat moment wordt ingedrukt wordt de ingestelde waarde voor deze parameter weergegeven en ingesteld.

Set up verlaten

- ▶ Om het gedeelte 'regeling' te verlaten de codeerknop opnieuw indrukken.
- ▶ Om de set up te verlaten, ga naar parameter "0" (opslaan en afsluiten) en de codeerknop in.
- ▶ Bevestig de handeling door de knop in te drukken .
- ▶ Om de wijziging op te slaan en de instelling te verlaten drukt u op de knop: .

5.1.1 Lijst parameters in de set up (MMA)

0 Opslaan en afsluiten



Om de wijzigingen op te slaan en de parameter te verlaten.

1 Reset



Om alle parameter weer op de fabrieksinstelling terug te brengen.

3 Hot start



Voor het regelen van de waarde van de hot start in MMA.

Voor een min of meer warme start in de fases van de ontsteking van de boog wat de startprocedure makkelijker maakt.

Basisch-elektrode

Minimaal	Maximaal	Fabrieksinstelling
0/uit	500%	80%

Cellulose-elektrode

Minimaal	Maximaal	Fabrieksinstelling
0/uit	500%	150%

CrNi-elektrode

Minimaal	Maximaal	Fabrieksinstelling
0/uit	500%	100%

Aluminium elektrode

Minimaal	Maximaal	Fabrieksinstelling
0/uit	500%	120%

Gietijzeren elektrode

Minimaal	Maximaal	Fabrieksinstelling
0/uit	500%	100%

Rutiel elektrode

Minimaal	Maximaal	Fabrieksinstelling
0/uit	500%	80%

7 Lasstroom



Voor het afstellen van de lasstroom.

Minimaal	Maximaal	Fabrieksinstelling
3 A	I _{max}	100 A

8 Arc force



Voor het regelen van de waarde van de Arc force in MMA.

Voor een min of meer krachtige dynamische reactie tijdens het lassen waardoor het werken voor de lasser gemakkelijker wordt.

Door de waarde van de arc-force te verhogen wordt de kans op vastkleven van de elektrode verlaagd.

Basisch-elektrode

Minimaal	Maximaal	Fabrieksinstelling
0/uit	500%	30%

Cellulose-elektrode

Minimaal	Maximaal	Fabrieksinstelling
0/uit	500%	350%

CrNi-elektrode

Minimaal	Maximaal	Fabrieksinstelling
0/uit	500%	30%

Aluminium elektrode

Minimaal	Maximaal	Fabrieksinstelling
0/uit	500%	100%

Gietijzeren elektrode

Minimaal	Maximaal	Fabrieksinstelling
0/uit	500%	70%

Rutiel elektrode

Minimaal	Maximaal	Fabrieksinstelling
0/uit	500%	80%

NL

204 Dynamic power control (DPC)



Maakt het mogelijk de gewenste V/A karakteristiek te selecteren.

I=C **Constante boog**

De toe- of afname van de booglengte heeft geen effect op de lasstroom.

Aanbevolen voor elektrode: Basisch, Rutiel, Acid, Staal, Gietijzer

1÷20 **Afbouwende karakteristiek met slopeafstelling**

De verlenging van de booglengte heeft een verlaging van de lasstroom tot gevolg (en omgekeerd) dit in de verhouding ampere staat tot voltage van 1 tot 20.

Aanbevolen voor elektrode: Cellulose, Aluminium

P=C **Wet van behoud van energie**

De verlenging van de booglengte veroorzaakt een verlaging van de lasstroom (en omgekeerd) en wel volgens de formule $V \cdot I = K$

Aanbevolen voor elektrode: Cellulose, Aluminium

312 Spanning booguitschakeling



Voor het instellen van de waarde van de spanning om de elektrische boog wordt uitgeschakeld.

Hierdoor worden de werkomstandigheden die zich voordoen beter beheerst.

Bij het puntlassen bijvoorbeeld zorgt een lage waarde van de spanning voor een minder grote vlam als de elektrode van het werkstuk wordt verwijderd waardoor spatten, verbranding en oxidatie van het werkstuk afnemen.



Stel de spanning voor het uitschakelen van de boog nooit hoger in dan nul lading spanning van de stroombron.

Basisch-elektrode

Minimaal	Maximaal	Fabrieksinstelling
0/uit	Vmax	57.0 V

Cellulose-elektrode

Minimaal	Maximaal	Fabrieksinstelling
0/uit	Vmax	70.0 V

399 Verplaatsingssnelheid



Hiermee wordt de snelheid ingesteld waarmee het laswerk wordt uitgevoerd.

Default cm/min: referentiesnelheid voor manueel lassen.

Syn: Sinergic waarde.

Minimaal	Maximaal	Fabrieksinstelling
2 cm/min	200 cm/min	15 cm/min

500 Machine-instelling



Maakt het kiezen van de gewenste grafische interface mogelijk.

Maakt de toegang mogelijk tot hogere instelling niveaus.

Raadpleeg het gedeelte "Interface personalisatie (Set up 500)"

Waarde	Geselecteerd niveau
USER	Gebbruiker
SERV	Service
vaBW	vaBW

Waarde	Gebbruikersinterface
XE	eenvoudige modus
XA	Gevorderde modus
XP	Professionele modus

551 Lock/unlock



Maakt het mogelijk de controle knoppen op het paneel te blokkeren en een bescherm code in te voeren.

Raadpleeg het gedeelte "Lock/unlock (Set up 551)".

552 Stapsgewijze aanpassing



Maakt aanpassing mogelijk van de verschillende stappen van de up-down toetsen.

Minimaal	Maximaal	Fabrieksinstelling
0/uit	10	10

601 Stapsgewijze regeling



Maakt het stapsgewijze regelen van de parameter met de persoonlijke instellingen van de lasser mogelijk.

Minimaal	Maximaal	Fabrieksinstelling
1	lmax	1

602 Externe parameter 2



Maakt de besturing mogelijk van de externe parameter 2 (minimale waarde, maximale waarde, waarde ingesteld door de fabriek, geselecteerde parameter).

705 Afstelling weerstand circuit

Voor het afstellen van de apparatuur.
Raadpleeg het gedeelte "Afstelling weerstand circuit (set up 705)".

751 Stroom aflezen

Toont de werkelijke waarde van de lasstroom.

752 Voltage aflezen

Toont de werkelijke waarde van het las voltage.

768 Meting warmtetoever H1

Hiermee kan de waarde van de warmtetoevermeting tijdens het lassen worden afgelezen.

5.1.2 Lijst parameters in setup (TIG)
0 Opslaan en afsluiten

Om de wijzigingen op te slaan en de parameter te verlaten.

1 Reset

Om alle parameter weer op de fabrieksinstelling terug te brengen.

2 Voor gas stroom tijd

Om de gasstroom vóór het ontsteken van de boog in te stellen en te regelen.
Om de toorts met gas te vullen en de werkplek voor het lassen in gereedheid te brengen.

Minimaal	Maximaal	Fabrieksinstelling
0/uit	99.9 s	0.1 s

3 Begin stroom

Maakt het mogelijk de beginnende lasstroom te regelen.
Maakt het mogelijk een heter of minder heet lasbad te krijgen direct nadat de boog is ontstaan.

Minimaal	Maximaal	Fabrieksinstelling	Minimaal	Maximaal	Fabrieksinstelling
1%	200%	50%	3 A	I _{max}	-

5 Begin stroom tijd

Maakt het mogelijk de tijd in te stellen waardoor de oorspronkelijke stroom gehandhaafd blijft.

Minimaal	Maximaal	Fabrieksinstelling
0/uit	99.9 s	0/uit

6 Opbouw lijn

Voor het instellen van de geleidelijke overgang van begin stroom naar de lasstroom.

Minimaal	Maximaal	Fabrieksinstelling
0/uit	99.9 s	0/uit

7 Lasstroom

Voor het afstellen van de lasstroom.

Minimaal	Maximaal	Fabrieksinstelling
3 A	I _{max}	100 A

8 Bilevel stroom



Voor het regelen van de secondaire stroom bij het lassen in bilevel.
De eerste druk op de toortsknop veroorzaakt de gasvoorstroom, de ontsteking van de boog en het lassen met beginstroom.

Wanneer de knop voor het eerst wordt losgelaten stijgt de stroom naar "I1".
Als de lasser de knop snel indrukt en weer loslaat wordt er overgegaan op "I2".
Door de knop snel in te drukken en weer los te laten wordt er weer overgegaan op "I1" enzovoorts.
Als de knop langer ingedrukt gehouden wordt daalt de stroom naar de eindstroom.
Als de knop wordt losgelaten gaat de boog uit terwijl het gas gedurende de gasnastroomtijd blijft stromen.

Minimaal	Maximaal	Fabrieksinstelling	Minimaal	Maximaal	Fabrieksinstelling
3 A	I _{max}	-	1%	500%	uit

10 Basisstroom



Voor het regelen van de basisstroom bij pulserend en snel pulserend lassen.

Minimaal	Maximaal	Fabrieksinstelling	Minimaal	Maximaal	Fabrieksinstelling
3 A	I _{sald}	-	1%	100%	50%

12 Puls frequentie



Maakt de regeling mogelijk van de puls frequentie.
Maakt betere resultaten mogelijk bij het lassen van dun materiaal en een betere esthetische kwaliteit van het bad.

Minimaal	Maximaal	Fabrieksinstelling
0.1 Hz	25 Hz	5 Hz

13 Pulse duty cycle



Maakt het mogelijk de inschakelduur bij het puls lassen te regelen.
Maakt het mogelijk de top stroom voor een kortere of langere tijd te handhaven.

Minimaal	Maximaal	Fabrieksinstelling
1 %	99 %	50 %

14 Snelle puls frequentie



Maakt de regeling mogelijk van de puls frequentie.
Maakt scherper ingestelde activiteit en betere stabiliteit van de elektrische boog mogelijk.

Minimaal	Maximaal	Fabrieksinstelling
0.02 KHz	2.5 KHz	0.25 KHz

15 Puls afbouwend



Maakt de instelling van up slope tijd mogelijk tijdens het puls lassen.
Maakt een geleidelijke overgang mogelijk van de top stroom naar de basis stroom, waardoor een min of meer zachte lasboog ontstaat.

Minimaal	Maximaal	Fabrieksinstelling
0/uit	100 %	0/uit

16 Afbouwvan de las



Voor het instellen van een geleidelijke overgang van de lasstroom naar de eindstroom.

Minimaal	Maximaal	Fabrieksinstelling
0/uit	99.9 s	0/uit

17 Eindstroom



Voor het afstellen van de eindstroom.

Minimaal	Maximaal	Fabrieksinstelling	Minimaal	Maximaal	Fabrieksinstelling
3 A	I _{max}	10 A	1 %	200 %	50 %

19 Eindstroom tijd



Maakt het mogelijk de tijd in te stellen tot hoe lang de stroom moet aan blijven.

Minimaal	Maximaal	Fabrieksinstelling
0/uit	99.9 s	0/uit

20 Na-gas stroomtijd



Voor het regelen van de lasstroom aan het eind van het lassen.

Minimaal	Maximaal	Fabrieksinstelling
0/uit	99.9 s	syn

203 Tig start (HF)

Maakt de keuze mogelijk van de gewenste boog werking.

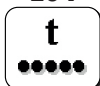
Waarde	Fabrieksinstelling	Callback-functie
aan	X	HF START
uit	-	LIFT START

204 Puntlassen

Zorgt ervoor de plaatselijk las procedure uit te voeren en stelt een lastijd in.

Maakt de tijdstelling mogelijk van het lasproces.

Minimaal	Maximaal	Fabrieksinstelling
0/uit	99.9 s	0/uit

205 Restart

Maakt het activeren mogelijk van de herstart functie.

Maakt het mogelijk om de boog onmiddellijk te doven tijdens de down slope of tijdens de herstart van het lasproces.

Waarde	Fabrieksinstelling	Callback-functie
0/uit	-	uit
1/on	X	aan
2/of1	-	uit

206 Easy joining

Maakt het mogelijk de boog te ontsteken met pulserende stroom en de functie in te stellen voordat de vooraf ingestelde las condities herstart.

Maakt hogere snelheid een meer precisie mogelijk tijdens het hechtlassen van de delen.

Minimaal	Maximaal	Fabrieksinstelling
0.1 s	25.0 s	0/uit

208 Microtime spot welding

Voor de activering van het proces "microtime spot welding".

Maakt de tijdstelling mogelijk van het lasproces.

Minimaal	Maximaal	Fabrieksinstelling
0.01 s	1.00 s	0/uit

399 Verplaatsingsnelheid

Hiermee wordt de snelheid ingesteld waarmee het laswerk wordt uitgevoerd.

Default cm/min: referentiesnelheid voor manueel lassen.

Syn: Sinergic waarde.

Minimaal	Maximaal	Fabrieksinstelling
2 cm/min	200 cm/min	10 cm/min

500 Machine-instelling

Maakt het kiezen van de gewenste grafische interface mogelijk.

Maakt de toegang mogelijk tot hogere instelling niveaus.

Raadpleeg het gedeelte "Interface personificatie (Set up 500)"

Waarde	Geselecteerd niveau	Waarde	Gebruikersinterface
USER	Gebruiker	XE	eenvoudige modus
SERV	Service	XA	Gevorderde modus
vaBW	vaBW	XP	Professionele modus

551 Lock/unlock

Maakt het mogelijk de controle knoppen op het paneel te blokkeren en een bescherm code in te voeren.

Raadpleeg het gedeelte "Lock/unlock (Set up 551)".

552 **Stapsgewijze aanpassing**



Maakt aanpassing mogelijk van de verschillende stappen van de up-down toetsen.

Minimaal	Maximaal	Fabrieksinstelling
0/uit	10	10

601 **Stapsgewijze regeling**



Maakt het stapsgewijze regelen van de parameter met de persoonlijke instellingen van de lasser mogelijk.

Minimaal	Maximaal	Fabrieksinstelling
1	Imax	1

602 **Externe parameter CH1, CH2, CH3, CH4**



Maakt de besturing mogelijk van de externe parameter 1, 2, 3, 4 (minimale waarde, maximale waarde, waarde ingesteld door de fabriek, geselecteerde parameter).

Raadpleeg het gedeelte "Beheer van externe controle (Set up 602)".

606 **U/D toorts**



Maakt de besturing mogelijk van de externe parameter (U/D).

Waarde	Fabrieksinstelling	Callback-functie
0/uit	-	uit
1/11	X	Stroom
	-	Programma ontsluiten

612 **Instelling DgTig toorts**



Hiermee kunnen de kanalen van de digitale toorts worden beheerd.

Waarde	Fabrieksinstelling	Callback-functie
0/uit	-	uit
1/11	-	Stroom
2/	-	Programma ontsluiten
3/CH3	-	CH3
4/CH4	-	CH4
5/STD	X	STD

705 **Afstelling weerstand circuit**



Voor het afstellen van de apparatuur.

Raadpleeg het gedeelte "Afstelling weerstand circuit (set up 705)".

751 **Stroom aflezen**



Toont de werkelijke waarde van de lasstroom.

752 **Voltage aflezen**



Toont de werkelijke waarde van het las voltage.

758 **Bewegingsnelheid van de robot**



Maakt het mogelijk dat de bewegingsnelheid van de arm van een robot of van een automatisch apparaat wordt getoond.

764 **Koelvloeistofstroom inlezen**



Toont de waarde van de koelvloeistofstroom.

765 **Temperatuur koelvloeistof aflezen**



Toont de werkelijke waarde van de temperatuur koelvloeistof.

768 **Meting warmtetoevoer HI**



Hiermee kan de waarde van de warmtetoevoermeting tijdens het lassen worden afgelezen.

801 **Bewaken van limieten**





Maakt het instellen mogelijk van de waarschuwingsgrens en van de bewaking van de limieten.
 Maakt het mogelijk dat het lasproces wordt gecontroleerd door het instellen van waarschuwinglimieten en bewakingslimieten voor de voornaamste meetbare parameters.
 Maakt een accurate controle mogelijk van de diverse las fases.

5.2 Specifieke gebruiksprocedures van de parameters

5.2.1 7 segmenten display personalificatie

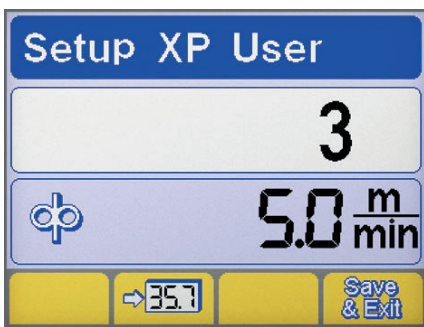
Hiermee kan de waarde van een parameter constant op het 7-segmenten-display worden weergegeven.



- ▶ Begin in set-up door de decoder knop minstens 5 seconden in te drukken.
- ▶ Selecteer de gewenste parameter door de decoder.
- ▶ Sla de geselecteerde parameter op in het 7 segmenten display door de knop in te drukken .
- ▶ Sla het op en verlaat het huidige scherm door de knop in te drukken .

5.2.2 Interface personalificatie (Set up 500)

Maakt het mogelijk dat de parameters worden aangepast op het hoofdmenu.













500 **Machine-instelling**



Maakt het kiezen van de gewenste grafische interface mogelijk.

Waarde	Gebruikersinterface
XE	eenvoudige modus
XA	Gevorderde modus
XP	Professionele modus

MODUS XE

MMA	
Lasparameters	
TIG	
Lasparameters	    
Functies	      

NL

MODUS XA

MMA	
Las parameters	
Functies	
TIG	
Las parameters	
Functies	

MODUS XP

MMA	
Las parameters	
Functies	
TIG	
Las parameters	
Functies	

NL

5.2.3 Lock/unlock (Set up 551)

Maakt het mogelijk de controle knoppen op het paneel te blokkeren en een bescherm code in te voeren.

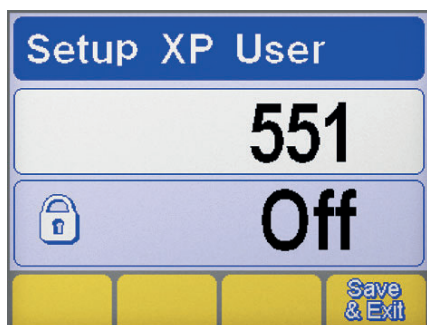

Selectie parameter

- ▶ Begin in set-up door de decoder knop minstens 5 seconden in te drukken.
- ▶ Selecteer de gewenste parameter (551).
- ▶ Activeer de regeling van de geselecteerde parameter door de decoder knop in te drukken.

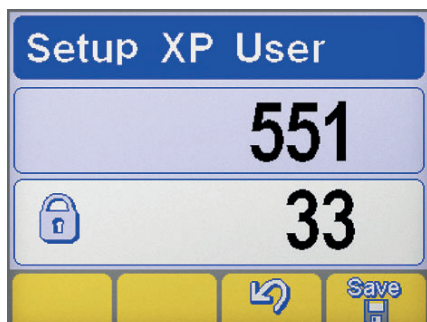

Wachtwoord instellen

- ▶ Stel een numerieke code (paswoord) in door de decoder te draaien.
- ▶ Druk op de encoder-toets om de bewerking te bevestigen.
- ▶ Bevestig de handeling door de knop in te drukken .
- ▶ Om de wijziging op te slaan drukt u op de knop: .

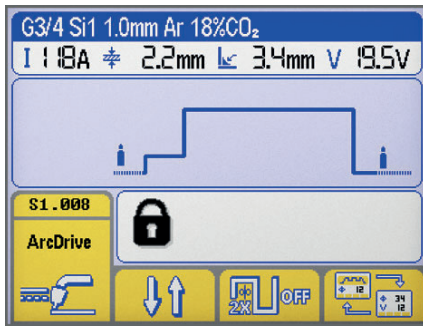

Funcities van het paneel



Het uitvoeren van elke handeling op een afgesloten controle paneel laat een speciaal scherm verschijnen.

- ▶ Tijdelijke toegang tot de functies op het paneel (5 minuten) door de decoder te draaien en het juiste paswoord in te voeren.
- ▶ Druk op de encoder-toets om de bewerking te bevestigen.
- ▶ Open het controle paneel definitief door in de set-up te beginnen (volg de instructies die hierboven gegeven zijn) en breng parameter 551 terug naar 'af'.
- ▶ Druk op de encoder-toets om de bewerking te bevestigen.
- ▶ Om de wijziging op te slaan drukt u op de knop:

5.2.4 Beheer van externe controle (Set up 602)

Maakt de besturing mogelijk van de externe parameter 2 (minimale waarde, maximale waarde, waarde ingesteld door de fabriek, geselecteerde parameter).

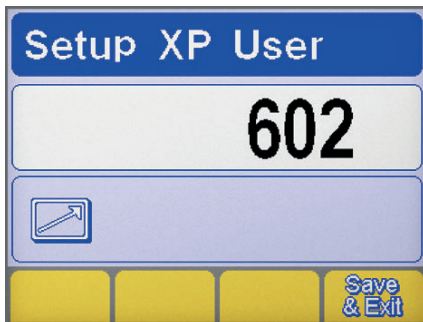

Selectie parameter

- ▶ Begin in set-up door de decoder knop minstens 5 seconden in te drukken.
- ▶ Selecteer de gewenste parameter (602).
- ▶ Begin in het "Externe controle beheer" scherm door de decoder knop in te drukken.

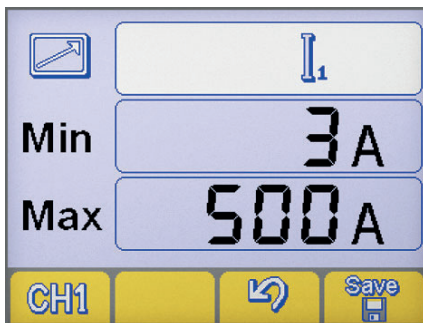

Beheer van externe controle

- ▶ Selecteer de gewenste RC afstandsbediening uitgang (CH1, CH2, CH3, CH4) door de knop in te drukken.
- ▶ Selecteer de gewenste parameter (Min-Max - parameter) door de knop van de decoder in te drukken.
- ▶ Pas de gewenste parameter aan (Min-Max - parameter) door de decoder te draaien.
- ▶ Om de wijziging op te slaan drukt u op de knop:
- ▶ Bevestig de handeling door de knop in te drukken

5.2.5 Afstelling weerstand circuit (set up 705)

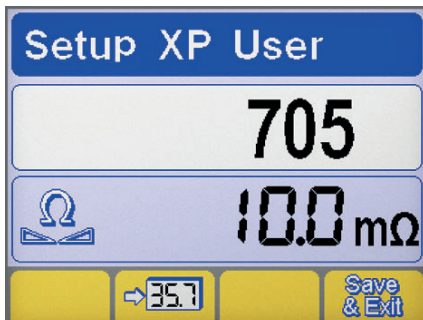

Selectie parameter

- ▶ Begin in set-up door de decoder knop minstens 5 seconden in te drukken.
- ▶ Selecteer de gewenste parameter (705).
- ▶ Activeer de regeling van de geselecteerde parameter door de decoder knop in te drukken.

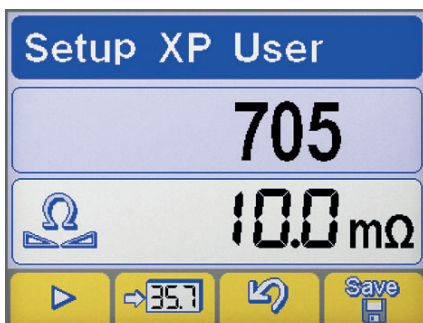

Afstelling

- ▶ Breng wolfram elektrode en lasstuk elektrisch met elkaar in contact. (TIG)
- ▶ Breng de toorts van de elektrodehouder en het te lassen stuk met elkaar in contact. (MMA)
- ▶ Druk op de knop (of de toorts schakelaar) om de procedure te starten.
- ▶ Houd het contact ten minste een seconde aan.
- ▶ De op het display weergegeven waarde wordt bijgewerkt nadat de afstelling is uitgevoerd.
- ▶ Bevestig de handeling door de knop in te drukken
- ▶ Bevestig de handeling door de knop in te drukken
- ▶ Om de wijziging op te slaan en de instelling te verlaten drukt u op de knop:

5.2.6 Bewaken van limieten (Set up 801)

Maakt het instellen mogelijk van de waarschuwingsgrenzen en van de bewaking van de limieten.

Maakt het mogelijk dat het lasproces wordt gecontroleerd door het instellen van waarschuwinglimieten en bewakingslimieten voor de voornaamste meetbare parameters.

Maakt een accurate controle mogelijk van de diverse las fases.

Raadpleeg het gedeelte "Bewaken van limieten (Set up 801)".



- | | |
|-----------------------------------|-------------------------------|
| Lasstroom | Lasspanning |
| Gasstroom aflezen | Bewegingsnelheid van de robot |
| Stroom aflezen (motor 1) | Stroom aflezen (motor 2) |
| Koelvloeistofstroom inlezen | Draadsnelheid aflezen |
| Temperatuur koelvloeistof aflezen | |

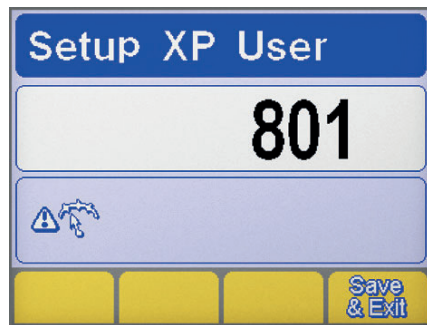

Selectie parameter

- ▶ Begin in set-up door de decoder knop minstens 5 seconden in te drukken.
- ▶ Selecteer de gewenste parameter (801).
- ▶ Begin in het Bewaak de limieten scherm door de decoder knop in te drukken.

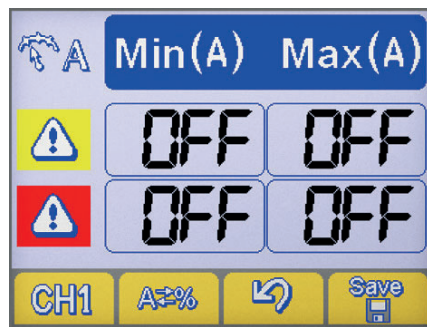

Selectie van de parameter

- ▶ Selecteer de gewenste parameter door knop in te drukken set **CH1**.
- ▶ Selecteer de instel methode van de bewakingslimieten door de knop in te drukken **A%**.

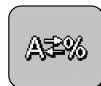

Machine-instelling



Absolute waarde



Waarde percentage

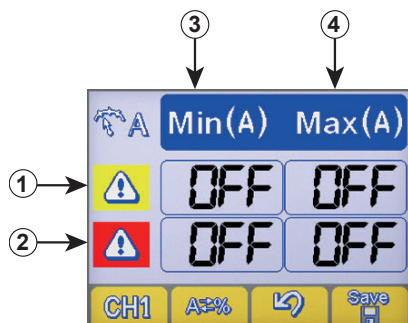

Instelling waarschuwingsgrenzen

- 1 Waarschuwinglimieten lijn
- 2 Alarm limieten lijn
- 3 Minimale niveaus kollom
- 4 Maximale niveaus kollom

- ▶ Selecteer de gewenste box door de decoder sleutel in te drukken (de geselecteerde box wordt getoond in spiegelbeeld).
- ▶ Pas het niveau van de geselecteerde limiet door de decoder te draaien.
- ▶ Om de wijziging op te slaan drukt u op de knop:

NL



Wanneer u één van de waarschuwinglimieten overschrijdt verschijnt er een visueel signaal op het controle paneel.



Wanneer u één van de alarm limieten overschrijd verschijnt er een visueel signaal op het controle paneel en volgt de onmiddellijke blokkade van de las handeling.



Het is mogelijk om het begin en het einde in te stellen van de las filters om foutieve signalen te voorkomen gedurende het aansteken en uitgaan van de boog (raadpleeg het gedeelte Set-up - Parameters 802-803-804).

6. ONDERHOUD



De normale onderhoud werkzaamheden moeten worden uitgevoerd volgens de richtlijnen die de fabrikant heeft verstrekt. Als de machine is ingeschakeld moeten alle ingangspunten en panelen zijn gesloten. De installatie mag op geen enkele manier worden gewijzigd. Voorkom ophoping van metaalstof bij of op het koelrooster.



Iedere onderhoud beurt dient te worden gedaan door gekwalificeerd personeel. Bij reparatie of vervanging van een onderdeel in de machine door onbevoegd personeel vervalt de garantie. De reparatie of vervanging van een onderdeel in de machine dient te worden gedaan door gekwalificeerd personeel.



Schakel de stroomtoevoer altijd uit voor u onderhoud pleegt.

6.1 Controleer de stroombron regelmatig als volgt

6.1.1 Zařizení



Reinig de machine aan de binnenkant door hem uit te blazen en af te borstelen met een zachte borstel. Controleer de elektrische aansluitingen en de kabels.

6.1.2 Voor het onderhoud of de vervanging van de toorts, elektrodetang en of aardkabels:



Controleer de temperatuur van het onderdelen en overtuig u ervan dat ze niet te heet zijn.



Draag altijd handschoenen die aan de veiligheids voorschriften voldoen.



Gebruik geschikte sleutels en gereedschap.

6.2 Odpovědnost



Als geen regelmatig onderhoud wordt uitgevoerd, vervalt de garantie en wordt de fabrikant van alle aansprakelijkheid ontheven. De fabrikant wijst ieder verantwoordelijkheid af wanneer de gebruiker zich niet houdt aan de volgende richtlijnen. In geval van twijfel of problemen aarzel niet contact op te nemen met uw leverancier.

7. ALARM CODES



ALARM

De tussenkomst van een alarm of de overschrijding van een kritieke waarschuwingsgrens veroorzaakt een visueel signaal op het bedieningspaneel en de onmiddellijke stopzetting van de laswerkzaamheden.



Let op!

De overschrijding van een waarschuwingsgrens veroorzaakt een visueel signaal op het bedieningspaneel maar de laswerkzaamheden kunnen worden voortgezet.

Hieronder volgt een lijst van alle alarmen en waarschuwingsgrenzen met betrekking tot het systeem.

 E01	Overtemperatuur		 E02	Overtemperatuur	
 E03	Overtemperatuur		 E05	Overstroom	
 E06	Overstroom vermogensmodule (Boost)		 E07	Storing voedingssysteem van draadtoevoermotor	
 E08	Geblokkeerde motor		 E10	Overstroom vermogensmodule (Inverter)	
 E11	Fout in systeemconfiguratie		 E13	Communicatiefout (FP)	
 E14.xx	Programma niet geldig de subcode van de fout geeft het nummer van de verwijderde taak aan		 E15	Programma niet geldig	
 E16	Communicatiefout (RI) (Automatisering en robot besturing)		 E18.xx	Programma niet geldig de subcode van de fout geeft het nummer van de verwijderde taak aan	
 E19	Fout in systeemconfiguratie		 E20	Defect geheugen	
 E21	Gegevensverlies		 E22	Communicatiefout (DSP)	
 E27	Defect geheugen (RTC)		 E29	Incompatibele metingen	
 E30	Communicatiefout (H.F.)		 E32	Gegevensverlies	
 E33	Fout in systeemconfiguratie (LCD 3.5")		 E38	Onderspanning	
 E39	Storing systeemvoeding		 E40	Storing systeemvoeding	
 E41	Overspanning		 E42	Onderspanning	

 E43	Geen koelvloeistof		 E49	Noodschakelaar (Automatisering en robot besturing)	
 E51	Instellingen niet ondersteund (Automatisering en robot besturing)		 E52	Antistoot (Automatisering en robot besturing)	
 E53	Fout externe flowschakelaar (Automatisering en robot besturing)		 E54	Stroomniveau overschreden (Onderste grens)	
 E55	Stroomniveau overschreden (Bovenste grens)		 E56	Spanningsniveau overschreden (Onderste grens)	
 E57	Spanningsniveau overschreden (Bovenste grens)		 E58	Stromingsniveau gas overschreden (Onderste grens)	
 E59	Stromingsniveau gas overschreden (Bovenste grens)		 E62	Stroomniveau overschreden (Onderste grens)	
 E63	Stroomniveau overschreden (Bovenste grens)		 E64	Spanningsniveau overschreden (Onderste grens)	
 E65	Spanningsniveau overschreden (Bovenste grens)		 E66	Stromingsniveau gas overschreden (Onderste grens)	
 E67	Stromingsniveau gas overschreden (Bovenste grens)		 E71	Overtemperatuur koelvloeistof	
 E72	Overstroom motor push-pull		 E73	Draadsnelheidslimiet overschreden (speed meter)	
 E75	Stroomniveau motor 2 overschreden		 E76	Stromingsniveau koelvloeistof overschreden	
 E77	Temperatuurniveau koelvloeistof		 E78	Onderhoud actief (Automatisering en robot besturing)	
 E81	Overstroom (pomp WU)		 E82	Communicatiefout (WU)	
 E83	Pomp geblokkeerd		 E99	Algemeen alarm	

8. MEEST VOORKOMENDE VRAGEN EN OPLOSSINGEN

De machine werkt niet (groene LED is uit)

Vraag

- » Geen stroom op het stopcontact.
- » Stopcontact of kabel defect.
- » Zekering doorgebrand.
- » Aan/uit schakelaar werkt niet.
- » Elektronica defect.

Oplossing

- » Controleer en indien nodig repareer de stroomtoevoer.
- » Laat dit uitvoeren door bevoegd personeel
- » Vervang het defecte onderdeel.
- » Neem contact op met uw leverancier om de machine te laten repareren.
- » Vervang het defecte onderdeel.
- » Vervang het defecte onderdeel.
- » Neem contact op met uw leverancier om de machine te laten repareren.
- » Neem contact op met uw leverancier om de machine te laten repareren.

Geen uitgaand vermogen (de machine last niet)

Vraag

- » Toortsknop defect
- » De machine raakt oververhit (thermisch alarm - gele LED aan)
- » Aard aansluiting niet goed.
- » Stroomaansluiting niet bereikbaar (gele led aan)
- » Afstandschakelaar defect.
- » Elektronica defect.

Oplossing

- » Vervang het defecte onderdeel.
- » Neem contact op met uw leverancier om de machine te laten repareren.
- » Wacht tot de machine is afgekoeld zonder hem uit te schakelen (gele LED uit).
- » Aardt de machine goed.
- » Raadpleeg de paragraaf "Installeren".
- » Breng de stroomaansluiting binnen het bereik van de stroombron.
- » Sluit het systeem goed aan.
- » Raadpleeg de paragraaf "Aansluitingen".
- » Vervang het defecte onderdeel.
- » Neem contact op met uw leverancier om de machine te laten repareren.
- » Neem contact op met uw leverancier om de machine te laten repareren.

Onjuist uitgaand vermogen

Vraag

- » Verkeerde keuze van las proces of defecte keuzeschakelaar.
- » De parameters of de functies zijn verkeerd ingesteld.
- » Potentiometer/encoder voor het regelen van de lasstroom defect.
- » Netspanning buiten bereik.
- » Er ontbreekt een fase.
- » Elektronica defect.

Oplossing

- » Kies het goede las proces.
- » Voer een systeemreset uit en stel de lasparameters opnieuw in.
- » Vervang het defecte onderdeel.
- » Neem contact op met uw leverancier om de machine te laten repareren.
- » Sluit het systeem goed aan.
- » Raadpleeg de paragraaf "Aansluitingen".
- » Sluit het systeem goed aan.
- » Raadpleeg de paragraaf "Aansluitingen".
- » Neem contact op met uw leverancier om de machine te laten repareren.

Boog instabiel

Vraag

- » Onvoldoende bescherm gas.

Oplossing

- » Pas de gasstroom aan.
- » Controleer of de gasverdeler en het gasmondstuk in goede staat zijn.

» Aanwezigheid van vocht in het gas.

» Gebruik altijd kwaliteitsproducten en materialen.
» Controleer of de gastoevoer in goede staat is.

» Las parameters niet correct.

» Voer een grondige controle uit van de lasapparatuur.
» Neem contact op met uw leverancier om de machine te laten repareren.

Teveel spetteren

Vraag

» De booglente niet correct.

Oplossing

» Verminder de afstand tussen de elektrode en het werkstuk.
» Verminder het voltage om te lassen.

» Las parameters niet correct.

» Verlaag de lasstroom.

» Onvoldoende bescherm gas.

» Pas de gasstroom aan.
» Controleer of de gasverdeler en het gasmondstuk in goede staat zijn.

» Lasboog niet regelmatig.

» Verhoog de inductie waarde.

» Wijze van lassen niet correct.

» Verminder de lashoek van de toorts.

Onvoldoende penetratie

Vraag

» Wijze van lassen niet correct.

Oplossing

» Voortgangsnelheid lassen verlagen.

» Las parameters niet correct.

» Verhoog de las stroom.

» Elektrode niet correct.

» Gebruik een elektrode met een kleinere diameter.

» Onjuiste voorbereiding van de werkstukken.

» Vergroot de lasopening.

» Aard aansluiting niet goed.

» Aardt de machine goed.
» Raadpleeg de paragraaf "Installeren".

» Te lassen werkstukken zijn te groot.

» Verhoog de las stroom.

Slakken

Vraag

» Slakken niet geheel verwijderd.

Oplossing

» Maak de stukken grondig schoon alvorens ze te lassen.

» Diameter van de elektrode te groot.

» Gebruik een elektrode met een kleinere diameter.

» Onjuiste voorbereiding van de werkstukken.

» Vergroot de lasopening.

» Wijze van lassen niet correct.

» Verminder de afstand tussen de elektrode en het werkstuk.
» Beweeg regelmatig tijdens het lassen.

Insluiten van de wolfram

Vraag

» Las parameters niet correct.

Oplossing

» Verlaag de lasstroom.
» Gebruik een elektrode met grotere diameter.

» Elektrode niet correct.

» Gebruik altijd kwaliteitsproducten en materialen.
» Elektrode goed slijpen.

» Wijze van lassen niet correct.

» Contact tussen elektrode en lasbad vermijden.

Blazen

Vraag

» Onvoldoende bescherm gas.

Oplossing

» Pas de gasstroom aan.
» Controleer of de gasverdeler en het gasmondstuk in goede staat zijn.

Plakken

Vraag

» De booglente niet correct.

Oplossing

» Vergroot de afstand tussen de elektrode en het werkstuk.
» Verhoog het las voltage.

» Las parameters niet correct.

» Verhoog de las stroom.

» Verhoog het las voltage.

» Wijze van lassen niet correct.

» Toorts schuiner houden.

» Te lassen werkstukken zijn te groot.

» Verhoog de las stroom.

» Verhoog het las voltage.

» Lasboog niet regelmatig.

» Verhoog de inductie waarde.

Inkartelingen

Vraag

» Las parameters niet correct.

Oplossing

» Verlaag de lasstroom.

» Gebruik een elektrode met een kleinere diameter.

» De booglente niet correct.

» Verminder de afstand tussen de elektrode en het werkstuk.

» Verminder het voltage om te lassen.

» Wijze van lassen niet correct.

» Verlaag de laterale oscillatiesnelheid bij het vullen.

» Voortgangsnelheid lassen verlagen.

» Onvoldoende bescherm gas.

» Gebruik voor het lassen materiaal geschikt gas.

Oxidatie

Vraag

» Onvoldoende bescherm gas.

Oplossing

» Pas de gasstroom aan.

» Controleer of de gasverdeler en het gasmondstuk in goede staat zijn.

Poreusheid

Vraag

» Smeer, lak, roest of stof op het las werkstuk.

Oplossing

» Maak de stukken grondig schoon alvorens ze te lassen.

» Smeer, lak, roest of stof op het lasmateriaal.

» Gebruik altijd kwaliteitsproducten en materialen.

» Houdt het lasmateriaal altijd in perfecte staat.

» Vocht in het lasmateriaal.

» Gebruik altijd kwaliteitsproducten en materialen.

» Houdt het lasmateriaal altijd in perfecte staat.

» De booglente niet correct.

» Verminder de afstand tussen de elektrode en het werkstuk.

» Verminder het voltage om te lassen.

» Aanwezigheid van vocht in het gas.

» Gebruik altijd kwaliteitsproducten en materialen.

» Controleer of de gastoevoer in goede staat is.

» Onvoldoende bescherm gas.

» Pas de gasstroom aan.

» Controleer of de gasverdeler en het gasmondstuk in goede staat zijn.

» Het lasbad stolt te snel.

» Voortgangsnelheid lassen verlagen.

» Verwarm de te lassen delen voor.

» Verhoog de las stroom.

Warmte scheuren

Vraag

» Las parameters niet correct.

Oplossing

» Verlaag de lasstroom.

» Gebruik een elektrode met een kleinere diameter.

» Smeer, lak, roest of stof op het las werkstuk.

» Maak de stukken grondig schoon alvorens ze te lassen.

» Smeer, lak, roest of stof op het lasmateriaal.

» Gebruik altijd kwaliteitsproducten en materialen.

» Houdt het lasmateriaal altijd in perfecte staat.

» Wijze van lassen niet correct.

» Volg de juiste werkmethode voor het betreffende las werk.

» Werkstukken met verschillende eigenschappen.

» Eerst bufferlaag aanbrengen.

Koude scheuren

Vraag

» Vocht in het lasmateriaal.

Oplossing

» Gebruik altijd kwaliteitsproducten en materialen.

» Houdt het lasmateriaal altijd in perfecte staat.

» Speciale meetkundige vorm van het te lassen werkstuk.

» Verwarm de te lassen delen voor.

» Het werkstuk naverwarmen.

» Volg de juiste werkmethode voor het betreffende las werk.

9. BEDIENINGSINSTRUCTIES

9.1 Handleiding lassen met beklede elektroden (MMA)

Vorbereiden van de lasnaden

Om goed lasresultaat te behalen adviseren wij u altijd te werken met schone materialen, zonder oxidatie, roest of andere verontreinigingen.

Keuze van de elektrode

De diameter van de elektrode die u moet gebruiken hangt af van de dikte van het materiaal, van de positie, het type van de lasnaad en het type voorbereiding van het werkstuk.

Elektrode met een grote diameter hebben van zelf sprekend zeer hoge lasstroom nodig met als gevolg grote warmtetoevoer tijdens het lasproces.

Type bekleding	Eigenschappen	Gebruik
Rutiel	eenvoudig in gebruik	in alle posities
Acid	Vlugge smelting	vlak
Basisch	Mechanische eigenschappen	in alle posities

Keuze van de lasstroom

Het bereik van de lasstroom van een bepaalde elektrode staat vermeld op de verpakking.

Starten en aanhouden van de boog

De lasboog wordt gestart door met punt van de elektrode het werkstuk, dat met een aardekabel aangesloten is, aan te tikken. Als de boog eenmaal is gestart trekt u de elektrode snel terug tot de normale las afstand. Meestal wordt om de boog sneller te laten aanslaan een stroomstoot (Hot Start) gegeven die de punt van de elektrode snel zal verwarmen.

Wanneer de boog eenmaal gevormd is begint het middelste deel van de elektrode te smelten waardoor kleine druppels ontstaan die het lasbad vormen op het werkstuk.

Het buitenste van de elektrode, de bekleding, wordt ontbonden en het gas dat daarbij vrijkomt dient als bescherming voor de las waardoor de goede kwaliteit van de las wordt gewaarborgd.

Om te voorkomen dat op het gesmolten materiaal de lasvlam dooft door kortsluiting en de elektrode aan het lasbad plakt, wordt de lasstroom tijdelijk verhoogd (Arc Force).

Wanneer de elektrode aan het werkstuk plakt kunt u het beste de kortsluitstroom tot minimale sterkte beperken (antisticking).

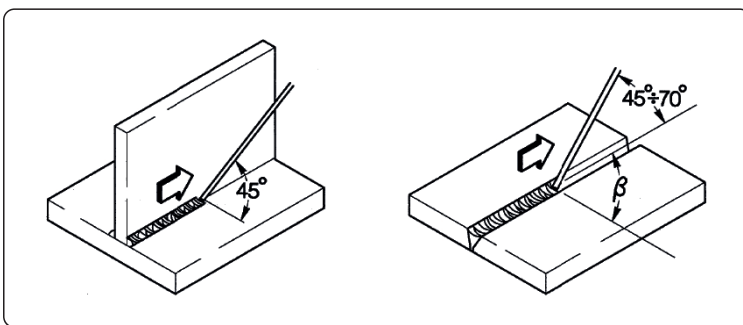

Het lassen

De laspositie varieert afhankelijk van het aantal doorgangen; gewoonlijk wordt de lasnaad gevormd door de elektrode heen en weer te bewegen op zo'n manier dat er geen ophoping van materiaal in het midden ontstaat.

Verwijderen van de slakken

Bij het lassen met beklede elektroden moeten na iedere lasdoorgang de slakken worden verwijderd.

U kunt de slak verwijderen met een kleine hamer of indien brokkelig met een borstel.

9.2 TIG-Lassen met onderbroken vlamboog

Beschrijving

Het principe van het Tig (Tungsten Inert Gas) lassen is gebaseerd op een elektrische boog die ontstaat tussen een niet verbruikbare elektrode (zuiver wolfram(tungsten) of een legering met een smelttemperatuur van ongeveer 3370°C) en het werkstuk; een edelgas (argon) beschermt het smeltbad tegen oxideren.

Om gevaarlijke wolframinsluitingen in de lasnaad moet de elektrode nooit in aanraking komen met het werkstuk, daarom wordt er door middel van een H.F.stroombron voor ontlading gezorgd waardoor de elektrische boog op afstand ontstoken kan worden. De elektrische vonk zorgt er dus voor dat de boog ontstaat zonder enig contact tussen de elektrode en het werkstuk.

Er is nog een start mogelijkheid met beperkte wolfram opname;: de lift start, hier voor is geen hoog frequent nodig, maar slechts een korte stroomstoot op lage snelheid tussen de elektrode en het werkstuk. Als de elektrode wordt opgetild ontstaat de boog en de stroom wordt opgevoerd tot de juiste waarde om te lassen.

Om de kwaliteit van de lasrups te verhogen is het belangrijk de daling van de stroom te controleren en het gas na het doven nog enige seconden door te laten stromen in het lasbad.

In veel werkomstandigheden is het nuttig als er bij het werk van twee lasstromen gebruik gemaakt kan worden en om eenvoudig van de ene naar de andere te kunnen omschakelen (BILEVEL).

Polariteit van de las

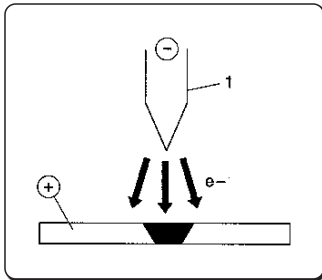

D.C.S.P.(Direct Current Straight Polarity)

Dit is de meest gebruikte polariteit. Deze laat een minimaal verbruik toe van de elektrode (1) omdat 70% van de warmte wordt geconcentreerd op de anode (werkstuk).

Hiermee kunnen smalle en diepe lassen gemaakt worden, met grote lassnelheid en lage warmte toevoer.

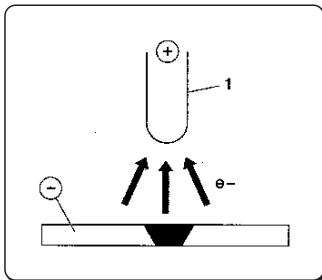

D.C.S.P.- (Direct Current Reverse Polarity)

Deze polariteit wordt gebruikt bij het lassen van legeringen die met een laag oxidatie waarvan het smeltpunt hoger ligt dan van het metaal.

Hoge lasstromen zijn echter niet mogelijk omdat daardoor de elektrode bijzonder hard zou slijten.

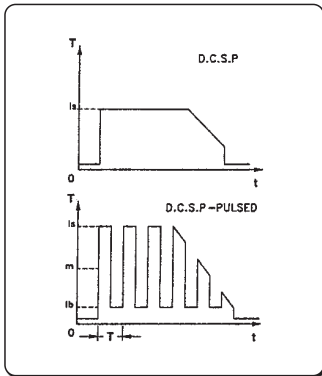

D.C.S.P. Pulseren (Direct Current Straight Polarity Pulsed)

Door het gebruik van een pulserende gelijkstroom is bij bijzondere werkomstandigheden een betere controle van het lasbad mogelijk.

Het lasbad wordt gevormd door de piekpulsen (I_p), terwijl de basisstroom (I_b) door laat branden; dit maakt het lassen van dunne werkstukken met minder vervormingen gemakkelijker, betere vormfactor en dus minder risico op kerven en gasinsluitingen.

Naar mate de frequentie stijgt (MF) wordt de boog smaller, meer geconcentreerd en stabiel, en dus een nog betere kwaliteit las bij het lassen van dunne werkstukken.

NL

Kenmerken van TIG-lassen

De Tig procedure is heel effectief voor het lassen van zowel koolstofstaal als gelegeerd staal, voor de eerste passage over pijpen evenals bij lassen die een optimaal esthetisch aspect moeten hebben.

Hiervoor is een directe polariteit noodzakelijk.(D.C.S.P.).

Vorbereiden van de lasnaden

Het is noodzakelijk de lasnaden zorgvuldig voor te bereiden en schoon te maken.

Keuze en voorbereiding van de elektrode

Het gebruik van thorium wolframelektroden (2% thorium, rood gekleurd) of als alternatief cerium of lanthanum elektroden met de volgende diameters:

Stroomgamma			Elektrode	
(DC-)	(DC+)	(AC)	∅	α
3-20 A	-	3-20 A	0,5 mm	30°
15-80 A	-	20-30 A	1,0 mm	30-60°
70-150 A	10-20 A	30-80 A	1,6 mm	60-90°
150-250 A	15-30 A	60-130 A	2,4 mm	90-120°
250-400 A	25-40 A	100-180 A	3,2 mm	120-150°
400-500 A	40-55 A	160-240 A	4,0 mm	150-180°
500-750 A	55-80 A	190-300 A	4,8 mm	150-180°
750-1100 A	80-125 A	325-450 A	6,4 mm	150-180°

De elektrode moet geslepen worden zoals aangegeven is in her schema.

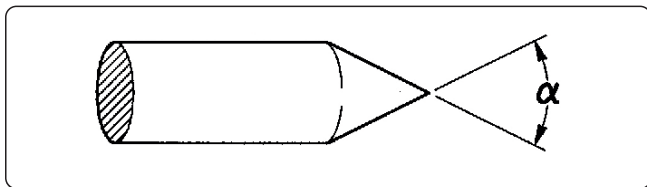

Toevoegmateriaal

De lasstaven moeten de zelfde eigenschappen hebben als het basismateriaal.

Het gebruik van stroken die van het basismateriaal afkomstig zijn is af te raden omdat deze allerlei onzuiverheden kunnen bevatten die een negatief effect kunnen hebben op de las kwaliteit.

Beschermgas

Hiervoor wordt bijna altijd zuivere argon (99,99%) gebruikt.

Stroomgamma			Gas	
(DC-)	(DC+)	(AC)	Mondstuk	Flow
3-20 A	-	3-20 A	n° 4	5-6 l/min
15-80 A	-	20-30 A	n° 5	6-8 l/min
70-150 A	10-20 A	30-80 A	n° 6	7-10 l/min
150-250 A	15-30 A	60-130 A	n° 7	8-12 l/min
250-400 A	25-40 A	100-180 A	n° 8	10-14 l/min
400-500 A	40-55 A	160-240 A	n° 8	12-16 l/min
500-750 A	55-80 A	190-300 A	n° 10	15-20 l/min
750-1100 A	80-125 A	325-450 A	n° 12	20-25 l/min

10. TECHNISCHE KENMERKEN

Elektrische kenmerken			U.M.
Netspanning U1 (50/60 Hz)	3x230 (±15%)	3x400 (±15%)	Vac
Zmax (@PCC) *	53	53	mΩ
Vertraagde lijnzekering	25	16	A
Can-bus aansluiting	DIGITAAL	DIGITAAL	
Maximaal opgenomen vermogen	10.5	10.5	kVA
Maximaal opgenomen vermogen	10.1	10.1	kW
Opgenomen vermogen in uitgeschakelde stand	51	51	W
Vermogen factor (PF)	0.96	0.96	
Rendement (μ)	83	83	%
Cos φ	0.99	0.99	
Maximaal opgenomen stroom I1max	30.8	15.3	A
Effectieve Stroom I1 eff	18	9	A
Instelbereik	3-270	3-270	A
Nullastspanning Uo	80	80	Vdc
Piekspanning Up	10.1	10.1	kV

* Deze apparatuur voldoet aan de EN / IEC 61000-3-11 norm.

* Deze apparatuur voldoet aan de norm EN / IEC 61000-3-12 als de maximaal toelaatbare stroom impedantie met betrekking tot de interface op het elektrische netwerk (bij een normale aansluiting) kleiner is dan of gelijk is aan de vastgestelde "Zmax" waarde. Wanneer het wordt aangesloten op het normale netwerk met een laag voltage, is het de verantwoordelijkheid van de installateur of de gebruiker van de apparatuur zich ervan te vergewissen, zonedig door de netwerkbeheerder te raadplegen, dat de apparatuur mag worden aangesloten.

Gebruiksfactor	3x230V	3x400V	U.M.
Gebruiksfactor (40°C)			
(X=35%)	270	270	A
(X=60%)	230	230	A
(X=100%)	180	180	A
Gebruiksfactor (25°C)			
(X=80%)	270	270	A
(X=100%)	240	240	A

Fysieke eigenschappen			U.M.
IP Beveiligingsgraad	IP23S		
Isolatieklasse	H		
Afmetingen (lxdxh)	500x190x400		mm
Gewicht	18.8		Kg
Gedeelte elektriciteitskabel	4x4		mm ²
Lengte van de stroomtoevoerkabel	5		m
Constructienormen	EN IEC 60974-1/A1:2019 EN IEC 60974-3:2019 EN 60974-10/A1:2015		

NL

11. GEGEVENSPLAAT

VOESTALPINE BÖHLER WELDING SELCO S.R.L. Via Palladio,19 - ONARA (PADOVA) - ITALY				
URANOS NX 2700 TLH			N°	
		EN 60974-1/A1:2019	60974-3:2019	
		60974-10/A1:2015 Class A		
Up 10.1 kV				
3A/10.0V - 270A (270A)/20.8V (20.8V)				
X (40°C)		35%	60%	100%
S	U ₀	I _z	270A (270A)	230A (230A)
	80V	U _z	20.8V (20.8V)	19.2V (19.2V)
		180A (180A)	17.2V (17.2V)	
3A/20.0V - 270A (270A)/30.8V (30.8V)				
X (40°C)		35%	60%	100%
S	U ₀	I _z	270A (270A)	230A (230A)
	80V	U _z	30.8V (30.8V)	29.2V (29.2V)
		180A (180A)	27.2V (27.2V)	
3-50/60 Hz		U ₁ 400V(230V)	I _{1max} 15.3A(30.8A)	I _{1eff} 9A(18A)
IP 23 S				
MADE IN ITALY				

12. BETEKENIS GEGEVENSPLAATJE

1		2			
3		4			
5		6			
7	9	23			
		11			
8	10	12	15	16	17
		13	15A	16A	17A
		14	15B	16B	17B
7	9	11			
		12	15	16	17
8	10	13	15A	16A	17A
		14	15B	16B	17B
		18	19	20	21
22					
MADE IN ITALY					

- 1 Fabrieksmerk
- 2 Naam en adres van de fabrikant
- 3 Model van de apparatuur
- 4 Serienummer
- XXXXXXXXXXXXXX Bouwjaar
- 5 Symbool van het type lasapparaat
- 6 Verwijzing naar de constructienormen
- 7 Symbool van het lasproces
- 8 Symbool voor lasapparaten die geschikt zijn om te werken in een omgeving met verhoogd risico op elektrische schokken
- 9 Symbool van de lasstroom
- 10 Nominale nullastspanning
- 11 Bereik van de maximale en minimale nominale lasstroom en de overeenkomstige traditionele lastspanning
- 12 Symbool van de intermitterende cyclus
- 13 Symbool van de nominale lasstroom
- 14 Symbool van de nominale lastspanning
- 15 Waarden van de intermitterende cyclus
- 16 Waarden van de intermitterende cyclus
- 17 Waarden van de intermitterende cyclus
- 15A Waarden van de nominale lasstroom
- 16A Waarden van de nominale lasstroom
- 17A Waarden van de nominale lasstroom
- 15B Waarden van de traditionele lastspanning
- 16B Waarden van de traditionele lastspanning
- 17B Waarden van de traditionele lastspanning
- 18 Symbool voor de voeding
- 19 Nominale voedingsspanning
- 20 Nominale maximale voedingsstroom
- 21 Effectieve maximale voedingsstroom
- 22 Beschermingsgraad
- 23 Nominale piekspanning

CE EU-Conformiteitsverklaring
 EAC EAC-Conformiteitsverklaring
 UKCA UKCA-Conformiteitsverklaring

NL

EU-FÖRSÄKRAN OM ÖVERENSSTÄMMELSE

Byggaren

voestalpine Böhler Welding Selco S.r.l. - Via Palladio, 19 - 35019 Onara di Tombolo (PD) - ITALY
Tel. +39 049 9413/111 - Fax +39 049 9413/311 - www.voestalpine.com/welding

förklarar under ensam ansvar att följande produkt:

URANOS NX 2700 TLH

55.07.042

55.07.043

överensstämmer med direktiven EU:

2014/35/EU LOW VOLTAGE DIRECTIVE

2014/30/EU EMC DIRECTIVE

2011/65/EU RoHS DIRECTIVE

2019/1784/EU EcoDesign

2009/125/EU EcoDesign

och att följande harmoniserade standarder har tillämpats:

EN IEC 60974-1/A1:2019

WELDING POWER SOURCE

EN IEC 60974-3:2019

ARC STRIKING AND STABILIZING DEVICES

EN 60974-10/A1:2015

ELECTROMAGNETIC COMPATIBILITY REQUIREMENTS

Dokumentationen som intygar överensstämmelse med direktiven kommer att finnas tillgänglig för inspektioner hos ovannämnda tillverkare.

Ingrepp eller modifieringar utan tillstånd av Böhler Welding Selco S.r.l. medför att denna försäkran inte längre är giltig.

Onara di Tombolo, 01/07/2024

voestalpine Böhler Welding Selco s.r.l.

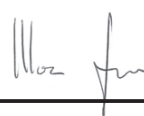

Mirco Frasson

Ivo Bonello

Managing Directors

INNEHÅLLSFÖRTECKNING

1. VARNING	260
1.1 Driftsmiljö	260
1.2 Personligt skydd och skydd för tredje man	260
1.3 Skydd mot rök och gas	261
1.4 Skydd mot bränder/explosioner	261
1.5 Försiktighetsåtgärder vid användning av gasbehållare	262
1.6 Skydd mot elektriska urladdningar	262
1.7 Elektromagnetiska fält och störningar	262
1.8 IP-skyddsgrad	263
1.9 Jååtmekååtlus	263
2. INSTALLATION	264
2.1 Lyftning, transport och lossning	264
2.2 Aggregatets placering	264
2.3 Inkoppling	264
2.4 Igångsättning	265
3. BESKRIVNING AV AGGREGATET	266
3.1 Bakre kontrollpanel	266
3.2 Kopplingstavla	266
3.3 Fråmre kontrollpanel	267
4. ANVÅNDNING AV UTRUSTNINGEN	268
4.1 Igångsättningsskårm	268
4.2 Huvudskårm	268
4.3 Huvudskårbild fr MMA-process	268
5. SETUP	272
5.1 Set-up och stålla in parametrar	272
5.2 Sårskilda procedurer fr anvåndning av parametrar	279
6. UNDERHÅLL	282
6.1 Periodiska kontroller av generatren	283
6.2 Odpowiedzialnoå	283
7. LARMKODER	283
8. FELSKNING OCH TIPS	285
9. ARBETSINSTRUKTIONER	288
9.1 Svetsning med belagd elektrod (MMA)	288
9.2 TIG-Svetsning (kontinuerlig båge)	289
10. TEKNISKA DATA	291
11. MÅRKPLÅT	292
12. MÅRKPLÅTENS INNEBRD	292
13. KOPPLINGSSHEMA	438
14. KONTAKTDON	440
15. RESERVDELSLISTA	441

SYMBOLER



Varning



Frbud



Skyldigheter



Allmånna indikationer

1. VARNING



Läs den här instruktionsboken ordentligt och se till att du har förstått anvisningarna innan du börjar arbeta med maskinen.

Modifiera inte maskinen och utför inget underhåll som inte anges här. Tillverkaren påtar sig inget ansvar för person- eller saksador som uppkommer till följd av att denna instruktionsbok inte har lästs uppmärksamt eller att instruktionerna i den inte har följts.

Förvara alltid bruksanvisningen på den plats där apparaten används. Följ utöver bruksanvisningen även de allmänna föreskrifterna och gällande lokala bestämmelser om förebyggande av olyckor och miljöskydd.

Voestalpine Böhler Welding Selco s.r.l. förbehåller sig rätten att modifiera produkten när som helst utan föregående meddelande.

Voestalpine Böhler Welding Selco s.r.l. förbehåller sig rättigheterna till och förbjuder översättning, reproduktion och anpassning, helt eller delvis, oavsett metod (inklusive fotostatkopior, film och mikrofilm) utan skriftligt tillstånd. Att dessa instruktioner följs är mycket viktigt och en förutsättning för att garantin ska gälla.

Tillverkaren påtar sig inget ansvar om operatören inte följer dessa anvisningar.



Alla personer som ansvarar för driftsättningen, användningen, underhållet och reparationen av apparaten ska

- ha rätt kvalifikation
- ha nödvändiga svetskunskaper
- läsa hela bruksanvisningen och följa den noggrant

Rådfråga fackman om du är tveksam till hur aggregatet ska användas eller om du får problem.

1.1 Driftsmiljö



Aggregaten får endast användas för de ändamål som de har konstruerats för, på de sätt och de områden som anges på märkplåten och/eller i denna instruktionsbok, i enlighet med nationella och internationella säkerhetsnormer. Användning som avviker från vad tillverkaren uttryckligen har föreskrivit ska betraktas som helt olämplig och farlig. Tillverkaren påtar sig inget ansvar i sådana fall.



Denna apparat får endast användas för professionellt bruk i industrimiljö. Tillverkaren påtar sig inget ansvar för skador som orsakas av att aggregatet används i hemmiljö.



Aggregatet ska användas i omgivningar med temperatur på mellan -10 °C och +40 °C (mellan +14 °F och +104 °F).

Aggregatet ska transporteras och förvaras i omgivningar med temperatur på mellan -25 °C och +55 °C (mellan -13 °F och +131 °F).

Miljön ska vara fri från damm, syror, gaser och andra frätande ämnen.

Den relativa luftfuktigheten ska vara högst 50 % vid 40 °C (104 °F).

Den relativa luftfuktigheten ska vara högst 90 % vid 20 °C (68 °F).

Aggregatet får användas på en höjd av högst 2000 m över havet (6500 fot).



Använd inte maskinen till att avfrostas rör.

Använd inte aggregatet för att ladda batterier och/eller ackumulatorer.

Använd inte aggregatet för att starta motorer.

1.2 Personligt skydd och skydd för tredje man



Svetsning ger upphov till skadlig strålning, buller, värme- och gasutveckling. Sätt upp en brandhärdig skiljevägg för att skydda svets från strålar, gnistor och het slagg. Varna eventuella utomstående för att de inte ska stirra på svetstället och uppmana dem att skydda sig emot strålning och het metall.



Använd skyddskläder samt svetshjälm för att skydda huden mot strålning. Använd arbetskläder som täcker hela kroppen och är:

- hela och i gott skick
- brandhärdiga
- isolerande och torra
- åtsittande och utan slag



Använd alltid skor som uppfyller kraven i regler och bestämmelser och är motståndskraftiga och vattenisolerande.



Använd alltid handskar som uppfyller kraven i regler och bestämmelser och som ger elektrisk och termisk isolering.



Använd masker med sidoskydd för ansiktet och lämpligt skyddsfiltre (minst NR10) för ögonen.



Använd alltid skyddsglasögon med sidoskydd, särskilt vid manuell eller mekanisk slaggborttagning.



Använd inte kontaktlinser!



Använd hörselskydd om svetsningen ger upphov till skadligt buller. Avgränsa arbetsområdet om bullernivån överskrider lagens gränser och tillse att de personer som kommer in i området har hörselskydd.



Håll alltid sidopanelerna stängda under svetsningen. Aggregatet får inte modifieras på något sätt.



Undvik att röra arbetsstycken som just har svetsats, eftersom den höga värmen kan medföra allvarliga brännskador. Vidtag alla ovan beskrivna försiktighetsåtgärder också vid bearbetning efter svetsningen, eftersom slag kan lossna från arbetsstycken som håller på att svalna.



Kontrollera att brännaren har svalnat innan du utför arbeten eller underhåll på den.



Kontrollera att kylvätskan är avstängd innan du kopplar loss matarslangen och returslangen för kylvätskan. Den heta vätskan kan ge allvarliga brännskador.



Ha första hjälpen-utrustning tillgänglig.
Banalisera inte brännskador eller sår.



Säkra det område du ansvarar för innan du lämnar arbetsplatsen, för att motverka risken för person- och saksador.

1.3 Skydd mot rök och gas



Rök, gas och damm som uppstår under svetsningen kan vara skadligt för hälsan.

Röksom uppstår under svetsningen kan under vissa omständigheter leda till cancer eller skador på gravida kvinnors foster.

- Håll huvudet på avstånd från svetsgaserna och svetsröken.
- Tillse att arbetsområdet har en tillräckligt god naturlig eller forcerad ventilation.
- Använd ansiktsmask med andningsapparat om ventilationen är otillräcklig.
- Vid svetsning i trånga utrymmen rekommenderar vi att operatören övervakas av en kollega som befinner sig utanför utrymmet i fråga.
- Använd inte syre för ventilationen.
- Kontrollera med jämna mellanrum att insugningen är effektiv genom att jämföra utsläppen av skadliga gaser med de värden som säkerhetsbestämmelserna tillåter.
- Hur mycket rök som produceras och hur farlig denna är beror på det använda grundmaterialet, svetsmaterialet och eventuella ämnen som används för att rengöra eller avfetta de arbetsstycken som ska svetsas. Följ tillverkarens anvisningar och tekniska instruktioner noggrant.
- Svetsa inte i närheten av platser där avfettning eller lackering pågår.
- Placera gasbehållarna i öppna utrymmen eller i utrymmen med god luftcirkulation.

1.4 Skydd mot bränder/explosioner



Svetsningen kan ge upphov till bränder och/eller explosioner.

- Avlägsna eldfarligt och brännbart material och föremål från arbetsområdet och dess omgivning.
- Inget brännbart material får finnas inom 11 meter (35 fot) från svetsstället om det inte skyddas ordentligt.
- Gnistor och glödande partiklar kan lätt komma ut i omgivningen också genom små öppningar. Var mycket noggrann med att sätta föremål och personer i säkerhet.
- Svetsa inte på eller i närheten av tryckutsatta behållare.

- Svetsa inte i stängda behållare eller rör. Var mycket försiktig vid svetsning av behållare eller tuber, även om dessa har öppnats, tömts och rengjorts noggrant. Rester av gas, bränsle, olja eller liknande kan medföra explosioner.
- Svetsa inte i atmosfär som innehåller damm, gas eller explosiva ångor.
- Kontrollera att den spänningsförande kretsen inte av misstag kan komma i kontakt med delar som är anslutna till jordkretsen när svetsningen är avslutad.
- Anordna med brandsläckningsutrustning eller ett brandskyddssystem i närheten av arbetsområdet.

1.5 Försiktighetsåtgärder vid användning av gasbehållare



Behållare med skyddsgas innehåller gas under tryck och kan explodera om inte minimivillkoren för transport, förvaring och användning är uppfyllda.

- Behållarna ska fästas i vertikalt läge i väggar eller annat på lämpligt sätt för att undvika fall och mekaniska sammanstötningar.
- Skruva på skyddshatten på ventilen under transport, idrifttagning och efter avslutad svetsning.
- Undvik att utsätta behållarna för direkt solljus och stora temperaturvariationer. Utsätt inte behållarna för mycket låga eller höga temperaturer.
- Undvik att behållarna kommer i kontakt med öppna lågor, elektriska bågar, brännare eller elektrodhållare och gnistor från svetsningen.
- Håll behållarna på avstånd från svetskretsarna och strömkretsar i allmänhet.
- Håll huvudet på avstånd från gasutloppet när du öppnar ventilen på behållaren.
- Stäng alltid ventilen på behållaren efter avslutad svetsning.
- Svetsa aldrig på tryckutsatta gasbehållare.
- Anslut aldrig en tryckluftsbehållare direkt till maskinens tryckregulator! Trycket kan överstiga tryckregulatorns kapacitet och få denna att explodera!

1.6 Skydd mot elektriska urladdningar



Elektriska urladdningar kan vara livsfarliga.

- Undvik att vidröra delar som normalt är spänningsförande inuti eller utanför svetsstaten när det är strömförsörjt (brännare, gripklor, jordledare, elektroder, trådar, valsar och rullar är elektriskt anslutna till svetskretsen).
- Se till att aggregatet och operatören isoleras elektriskt genom att använda torra plan och underreden som är tillfredsställande isolerade från nollpotentialen och jordpotentialen.
- Se till att aggregatet ansluts korrekt till en stickpropp och ett jordat elnät.
- Vidrör inte två brännare eller två elektrodhållare samtidigt.
- Avbryt omedelbart svetsningen om du får en elektrisk stöt.



Bågens anslags- och stabiliseringsenhet har konstruerats för drift som styrs manuellt eller mekaniskt.



Om skärbrännar- eller svetskablar förlängs till mer än 8 m ökar risken för elstötar.

1.7 Elektromagnetiska fält och störningar



När strömmen passerar genom ledningarna i och utanför aggregatet skapas ett elektromagnetiskt fält i svetskablar och aggregatets omedelbara närhet.

- Elektromagnetiska fält kan ha (hittills okända) hälsoeffekter för den som exponeras långvarigt för dem.
- Elektromagnetiska fält kan interferera med annan utrustning som pacemakrar och hörapparater.



Bärare av livsuppehållande elektronisk apparatur (pacemaker) måste konsultera läkare innan de närmar sig platser där bågs svetsning.

1.7.1 EMC-klassificeras i enlighet med: EN 60974-10/A1:2015.



Utrustning i klass B följer kraven på elektromagnetisk kompatibilitet för industri- och boendemiljöer, inklusive för bostadsområden där el levereras via det allmänna lågspänningsnätet.



Utrustning i klass A är inte avsedd för bruk i bostadsområden där elen levereras via det allmänna lågspänningsnätet. Det kan vara svårt att garantera elektromagnetisk kompatibilitet för utrustning i klass A på sådana platser, på grund av såväl ledningsbundna som strålade störningar.

För mer information, se kapitlet: MÄRKPLÅT eller TEKNISKA DATA.

1.7.2 Installation, drift och omgivningsbedömning

Denna apparat är konstruerad i överensstämmelse med anvisningarna i den harmoniserade standarden EN 60974-10/A1:2015 och tillhör Klass A. Denna apparat får endast användas för professionellt bruk i industrimiljö. Tillverkaren påtar sig inget ansvar för skador som orsakas av att aggregatet används i hemmiljö.



Användaren ska vara expert på området och är som sådan ansvarig för att apparaten installeras och används enligt tillverkarens anvisningar. Vid eventuella elektromagnetiska störningar ska användaren lösa problemet med hjälp av tillverkarens tekniska service.



De elektromagnetiska störningarna måste alltid minskas så mycket att de inte medför besvär.



Innan apparaten installeras ska användaren bedöma vilka eventuella elektromagnetiska problem som kan uppstå i det omgivande området och särskilt hälsotillståndet hos personalen i området, till exempel de som använder pacemakrar eller hörapparater.

1.7.3 Krav på nätanslutningen

På grund av att primärströmmen dras från nätanslutningen kan högeffektsutrustning påverka ledningsnätets ström kvalitet. Av den anledningen kan det förekomma anslutningsbegränsningar eller krav på en maximal impedans som tillåts i elnätet (Z_{max}) eller en minsta tillförselskapacitet (S_{sc}) som krävs vid gränssnittet mot det allmänna ledningsnätet (leveranspunkten) för viss utrustning (se tekniska data). Om så är fallet är det den som installerar eller använder utrustningen som ansvarar för att kontrollera att utrustningen får anslutas (genom att rådfråga elnätstjänstleverantören vid behov). Vid störningar kan man behöva vidta ytterligare försiktighetsåtgärder, såsom filtrering av nätströmmen.

Man bör också överväga möjligheten att skärma strömförsörjningskabeln.

För mer information, se kapitlet: TEKNISKA DATA.

1.7.4 Försiktighetsåtgärder avseende kablar

Följ nedanstående anvisningar för att minimera effekterna av de elektromagnetiska fälten:

- Rulla ihop jordledaren och elkabeln och fäst dem när så är möjligt.
- Undvik att rulla ihop kablarna i närheten av kroppen.
- Undvik att vistas mellan jordledaren och elkabeln (hålla båda på samma sida).
- Ledningarna ska hållas så korta som möjligt och ska placeras nära varandra och löpa på eller i närheten av golvnivån.
- Placera aggregatet på avstånd från svetszonen.
- Placera kablarna på avstånd från eventuella andra kablar.

1.7.5 Ekvipotentiaförbindning

Man bör överväga att jorda alla metalldelar i svetsanläggningen och i dess närhet. Följ nationella bestämmelser om ekvipotentiaförbindning.

1.7.6 Jordning av arbetsstycket

Om arbetsstycket av säkerhetsskäl eller beroende på dess storlek eller placering inte är jordat kan en jordledning mellan arbetsstycket och jorden minska emissionerna. Man måste se till att jordningen av arbetsstycket inte ökar risken att användarna skadas eller skadar andra elektriska apparater. Följ nationella bestämmelser om jordning.

1.7.7 Skärmning

Selektiv skärmning av andra kablar och apparater i omgivningarna kan minska störningsproblemen.

För speciella applikationer kan man överväga att skärma hela svetsanläggningen.

1.8 IP-skyddsgrad



IP23S

- Höljet förhindrar att man kommer åt farliga delar med fingrarna och skyddar mot fasta främmande föremål med en diameter på 12,5 mm eller mer.
- Höljet skyddar mot regn i 60° vinkel mot vertikalled.
- Höljet är skyddat mot skador till följd av inträngande vatten när utrustningens rörliga delar inte är i rörelse.

1.9 Jåtmekåitlus



Bortskaffa inte elutrustningen tillsammans med vanligt avfall!

I enlighet med direktiv 2012/19/EU om avfall som utgörs av eller innehåller elektrisk och elektronisk utrustning och bestämmelserna om dess införlivande med nationell lagstiftning ska uttjänad elutrustning samlas in separat och lämnas till en samlings- och återvinningscentral. Utrustningens ägare ska vända sig till kommunen för att identifiera de auktoriserade samlingscentralerna. Tillämpningen av EU-direktivet kommer att bidra till att förbättra miljön och människors hälsa.

» Besök webbplatsen för mer information.

2. INSTALLATION



Endast personal med specialkunskaper och tillstånd från tillverkaren får installera kylenheten.



Se till att generatorn är ansluten till elnätet innan installationen görs.



Det är förbjudet att serie- eller parallellkoppla generatorerna.

2.1 Lyftning, transport och lossning

- Aggregatet har ett handtag så att du kan bära det.



Underskatta inte aggregatets vikt, se tekniska data.
Förflytta eller stoppa inte lasten ovanför människor eller föremål.
Låt inte aggregatet eller en enskild enhet falla eller ställas ned med en kraftig stöt.

2.2 Aggregatets placering



Tillämpa följande kriterier:

- Kommandon och kopplingar ska vara lättillgängliga.
- Placera inte utrustningen i trånga utrymmen.
- Placera inte aggregatet på ett plan som lutar mer än 10° i relation till horisontalplanet.
- Placera aggregatet på torr, ren plats med god ventilation.
- Skydda aggregatet mot regn och direkt solljus.

2.3 Inkoppling



Generatorn har en elsladd för anslutning till elnätet.
Strömförsörjningen till aggregatet kan vara:

- trefas 230 V
- trefas 400 V

Aggregatets funktion garanteras för spänningar som avviker upp till $\pm 15\%$ från det nominella värdet.



För att undvika personskador eller skador på aggregatet måste man kontrollera den valda nätspänningen och säkringarna INNAN maskinen ansluts till elnätet. Se dessutom till att kabeln ansluts till ett jordat uttag.



Aggregatet kan få sin strömtillförsel via en elgenerator på villkor att denna ger en stabil matningsström på $\pm 15\%$ av den nominella spänning som tillverkaren uppger under alla tänkbara driftförutsättningar och vid svetsgeneratorns maximala effekt. Som regel rekommenderas generatorer med 2 gånger så hög effekt som svetsgeneratorn vid enfasmatning och 1,5 gånger vid trefasmatning. Vi rekommenderar elektroniskt styrda elgeneratorer.



Aggregatet måste vara korrekt jordat för att skydda användarna. Strömförsörjningskabeln innehåller en gul/grön jordledning som ska anslutas till en jordad stickpropp. Denna gul-gröna ledning får ALDRIG användas tillsammans med en annan ledning för att leda ström. Kontrollera att elsystemet är jordat och att eluttaget är i gott skick. Montera endast godkända kontakter som uppfyller säkerhetsbestämmelserna.



Elsystemet ska utformas av teknisk personal som besitter särskilda yrkeskunskaper och arbetar i enlighet med lagstiftningen i det land där installationen görs.

2.4 Igångsättning

2.4.1 Anslutning för MMA-svetsning



En inkoppling som den i figuren resulterar i svetsning med omvänd polaritet. Kasta om kopplingarna för svetsning med normal polaritet.

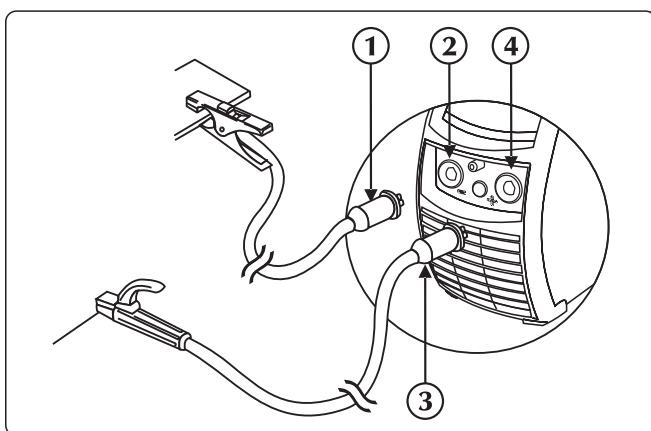



- ① Jordklämkontakt
- ② Negativt uttag (-)
- ③ Elektrodhållarens klämkontakt
- ④ Positivt uttag (+)

- ▶ Anslut jordklämman till kraftaggregatets negativa uttag (-). Sätt i stickproppen och vrid medsols så att den fästs ordentligt.
- ▶ Anslut elektrodhållaren till kraftaggregatets positiva uttag (+). Sätt i stickproppen och vrid medsols så att den fästs ordentligt.

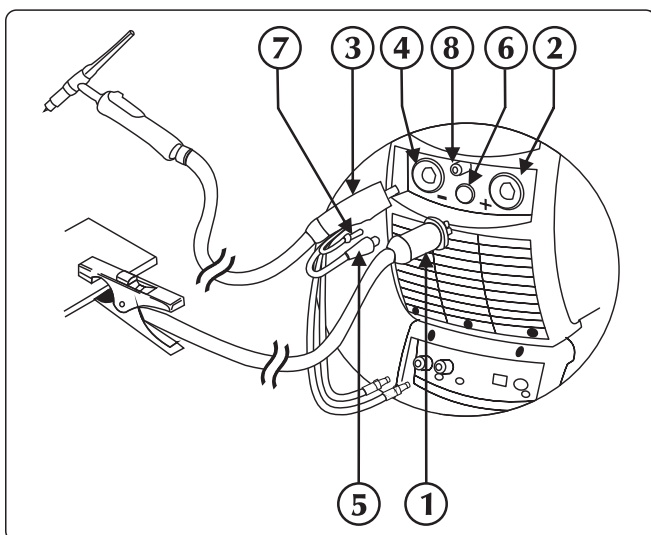
2.4.2 Anslutning för TIG-svetsning



- ① Jordklämkontakt
- ② Positivt uttag (+)
- ③ TIG-fackelfäste
- ④ Brännaruttag
- ⑤ Brännarens signalkabel
- ⑥ Kontaktdon
- ⑦ Fackla gasrör
- ⑧ Koppling/anslutning gas

- ▶ Anslut jordklämman till kraftaggregatets positiva uttag (+). Sätt i stickproppen och vrid medsols så att den fästs ordentligt.
- ▶ Anslut TIG-brännarens koppling till kraftaggregatets brännaruttag. Sätt i stickproppen och vrid medsols så att den fästs ordentligt.
- ▶ Anslut brännarens signalkabel till rätt kontakt.
- ▶ Koppla aggregatets gasslang till rätt koppling/anslutning.
- ▶ Anslut returslangen för kylvätska från brännaren (röd) till kopplingen (röd - symbol )
- ▶ Anslut matarslangen för kylvätska till brännaren (blå) till kopplingen (blå - symbol )

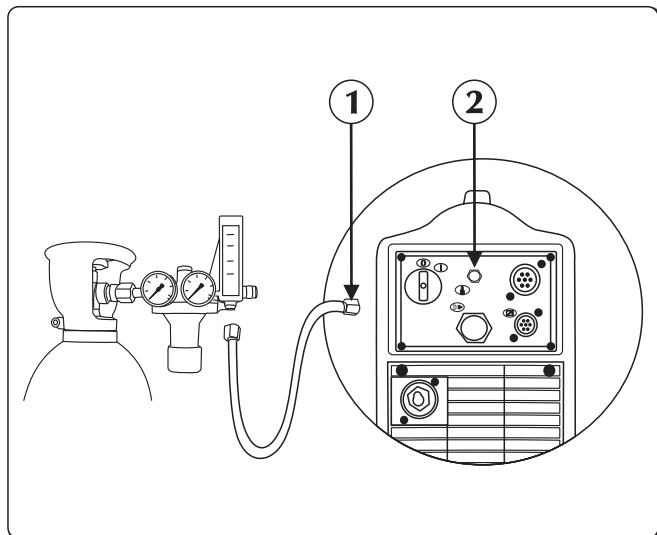

- ① Gasrör
- ② Koppling/anslutning gas

► Anslut gasslangen från gasbehållaren till det bakre gasuttaget. Ställ in gasflödet på mellan 5 och 15 l/min.

3. BESKRIVNING AV AGGREGATET

3.1 Bakre kontrollpanel

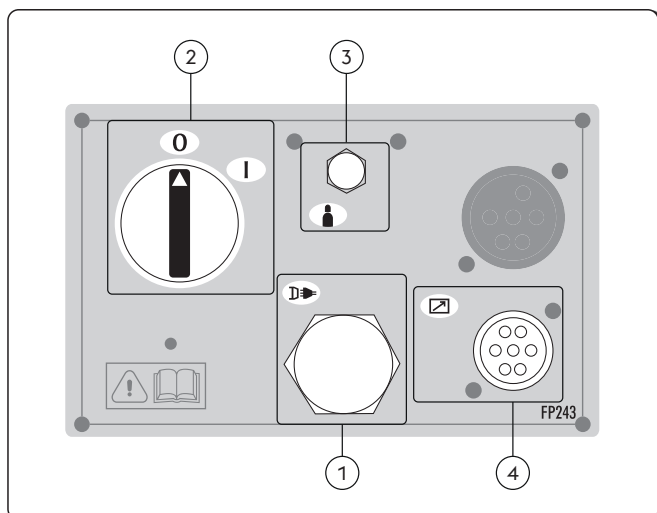

- ① Strömförsörjningskabel
För att strömförsörja anläggningen via elnätet.
- ② Huvudströmbrytare
Slår till eltillförseln till aggregatet.
Har två lägen: "O" avstängd och "I" påslagen.
- ③ Anslutning för gasledning
- ④ Uttag för signalkabel CAN-buss (RC, RI...)



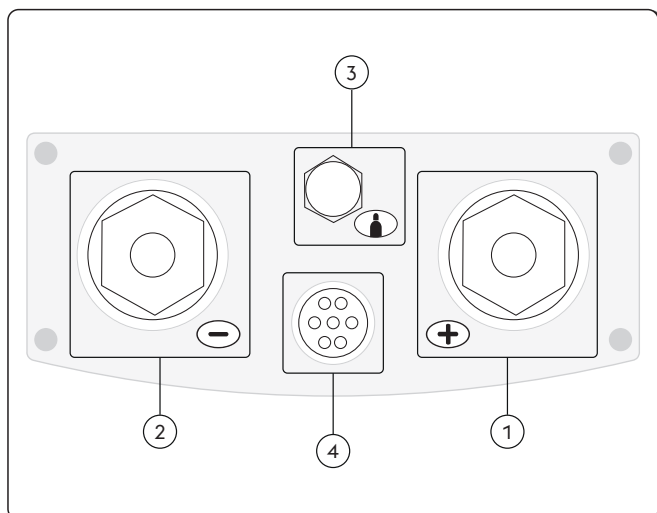



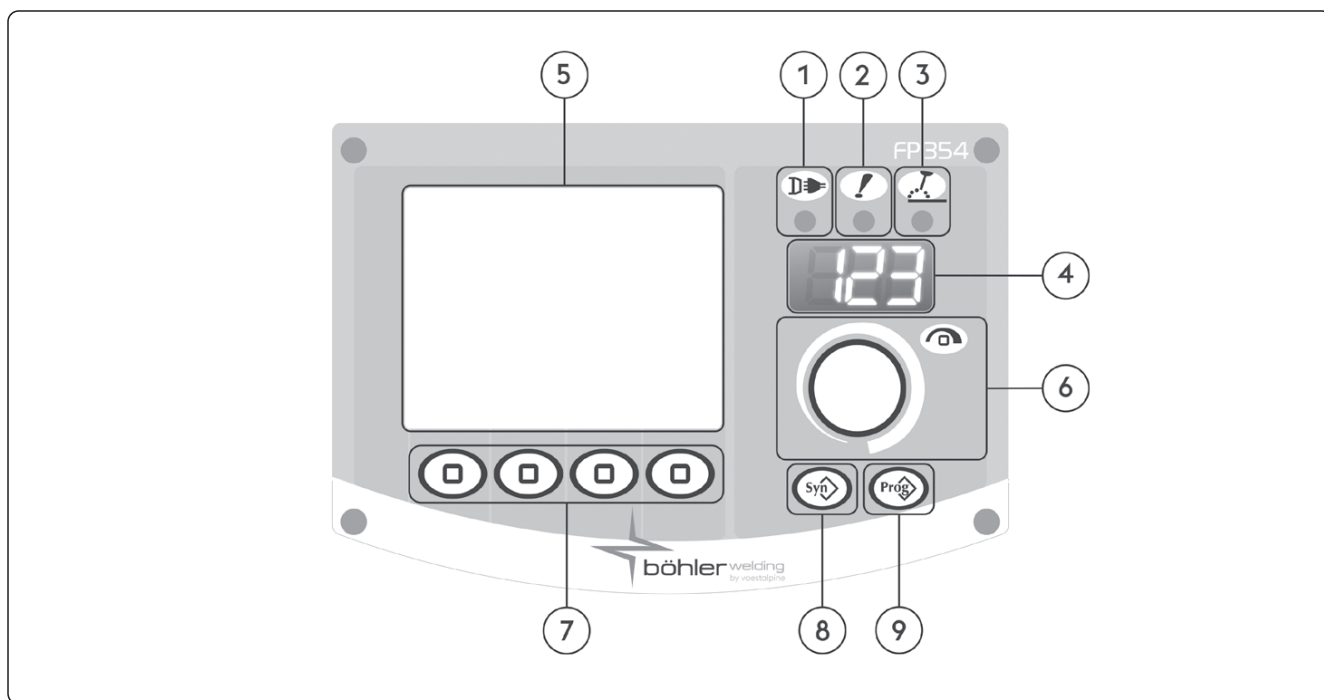

3.2 Kopplingstavla







- ① Positivt uttag (+)
Process MMA: Anslutning elektrodbrännare
Process TIG: Anslutning jordkabel
- ② Negativt uttag (-)
Process MMA: Anslutning jordkabel
Process TIG: Anslutning av brännare
- ③ Anslutning för gasledning
- ④ Ingång för signalkabel (TIG-brännare)

3.3 Främre kontrollpanel

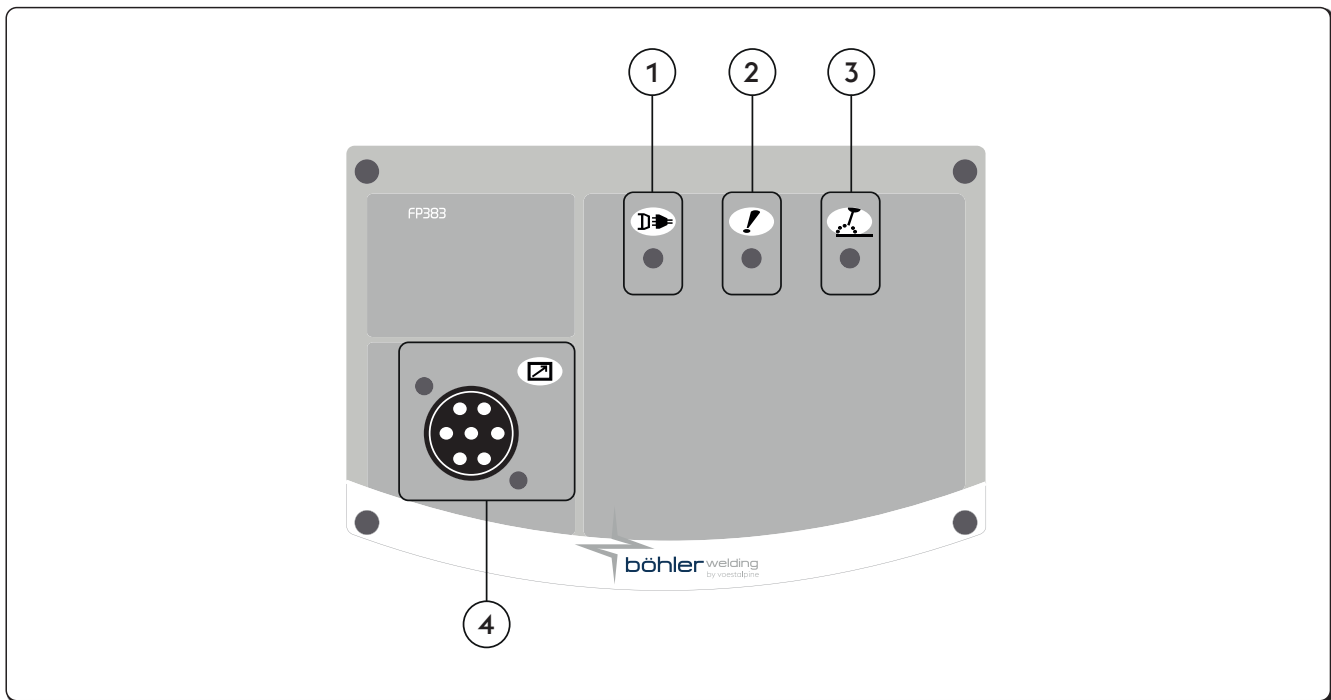

- 1  **Ström-LED**
Visar att utrustningen är ansluten till elnätet och påslagen.
- 2  **Allmänt larm-LED**
Visar när skyddsutrustning som temperaturkyddet aktiveras.
- 3  **Aktiv effekt-LED**
Visar att det finns ström i utrustningens utgångar.
- 4  **Display med 7 segment**
Här visas de allmänna svetsparametrarna under start, inställningar, ström- och spänningsvärden vid svetsning samt larmkoder.
- 5  **LCD-display**
Här visas de allmänna svetsparametrarna under start, inställningar, ström- och spänningsvärden vid svetsning samt larmkoder.
Alla aktiviteter kan visas utan fördröjning.
- 6  **Huvudjusteringshandtag**
Används för att ställa in svetsningsströmmen.
Gör det möjligt att konfigurera, välja och ställa in svetsparametrar.
- 7  **Funktionsknappar**
Medger val av olika systemfunktioner:
- Svetsprocess
- Svetsmetoder
- Strömpulsning
- Grafiskt gränssnitt
- 8  **Ledig knapp**
- 9  **Knapp för jobb**
Medger lagring och hantering av 240 jobb som kan anpassas till den enskilda användaren.



- ①  **Ström-LED**
Visar att utrustningen är ansluten till elnätet och påslagen.
- ②  **Allmänt larm-LED**
Visar när skyddsutrustning som temperaturkyddet aktiveras.
- ③  **Aktiv effekt-LED**
Visar att det finns ström i utrustningens utgångar.
- ④  **Uttag för signalkabel CAN-buss (RC, RI...)**

4. ANVÄNDNING AV UTRUSTNINGEN

4.1 Igångsättningskärmen

Vid starten utför aggregatet ett antal kontroller för att säkerställa korrekt funktion av aggregatet och även av alla anordningar som är anslutna till aggregatet. I samma skede genomförs också gastestet för att kontrollera att systemet för gastillförsel fungerar korrekt.

4.2 Huvudskärmen

Används för att styra systemet och svetsprocessen. De viktigaste inställningarna visas.

4.3 Huvudskärmbild för MMA-process

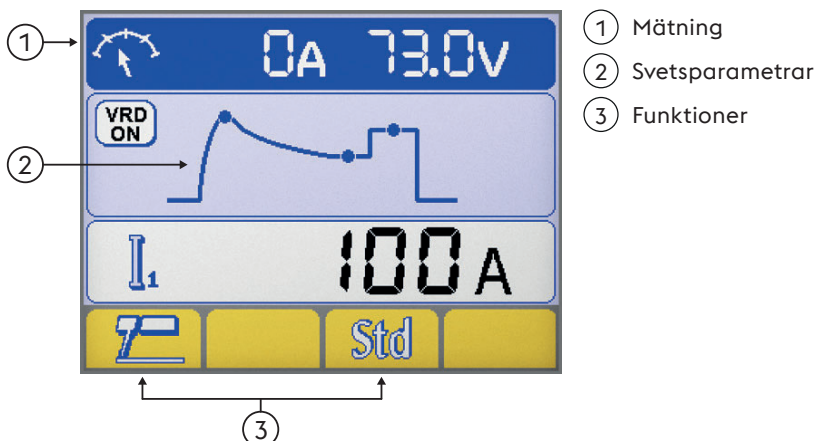

Mätning

Under svetsningen visas de verkliga ström- och spänningsvärdena på LCD-displayen.

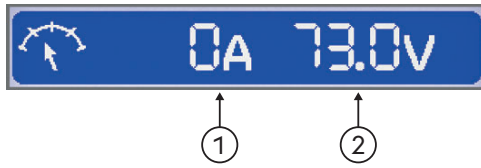

- ① Svetsström
- ② Arbetsspänning

Svetsparametrar

► Välj önskad parameter genom att trycka på kodningsvredet.

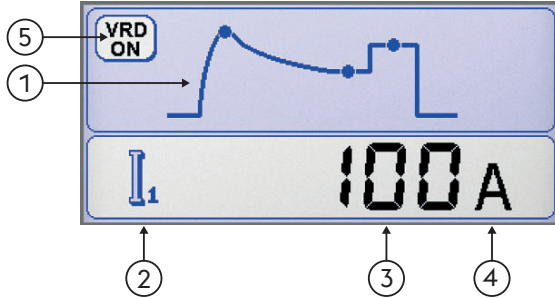

- ① Svetsparametrar
- ② Parameterikon
- ③ Parametervärde
- ④ Måttenhet för parametervärdet
- ⑤ VRD (Voltage Reduction Device) Spänningsreduceringsenhet
Visar att utrustningens obelastade spänning är övervakad.

Funktioner

Medger inställning av de viktigaste processfunktionerna och svetsmetoderna.

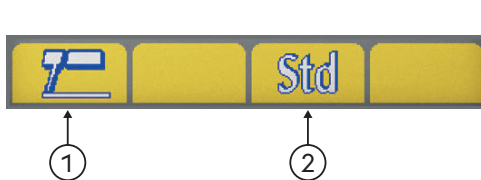

- ① Svetsprocess
- ② Synergisk MMA-svetsning



Svetsprocess

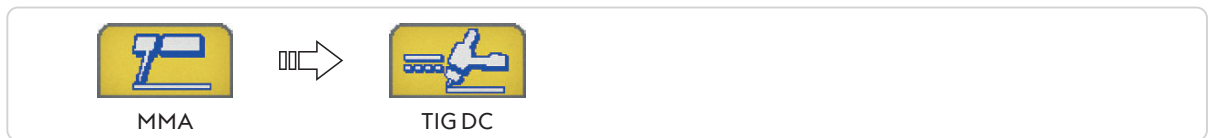

Synergisk MMA-svetsning

För inställning av den bästa bågodynamiken beroende på den typ av elektrod som används.

Genom att välja rätt bågodynamik kan strömkällan utnyttjas maximalt och bästa möjliga svetssegenskaper uppnås.



Perfekt svetsbarhet hos elektroden kan inte garanteras.

Svetsbarheten beror på tillsatsmateriallets kvalitet och skick, drifts- och svetsförhållandena, antalet möjliga användningsområden m.m.

4.4 Huvudskärmbild för TIG-process



Mätning

Under svetsningen visas de verkliga ström- och spänningsvärdena på LCD-displayen.

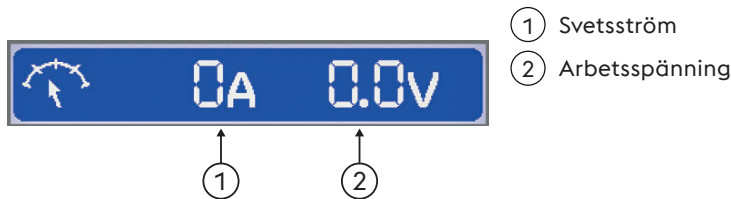

Svetsparametrar

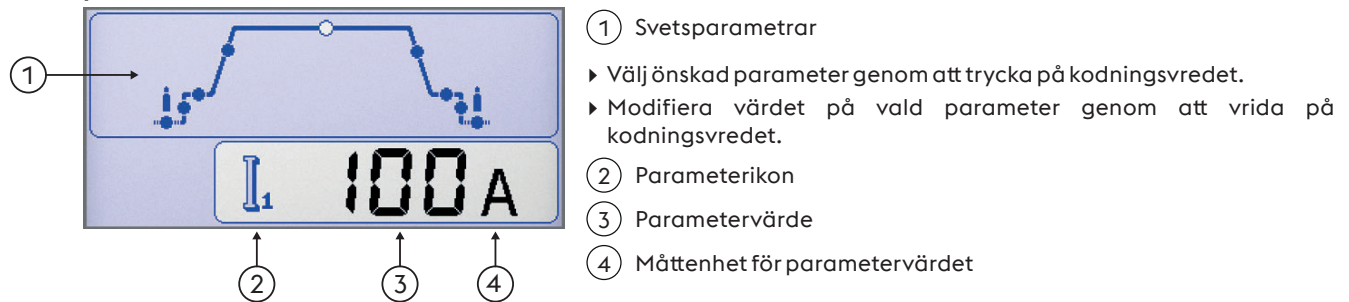

Funktioner

Medger inställning av de viktigaste processfunktionerna och svetsmetoderna.

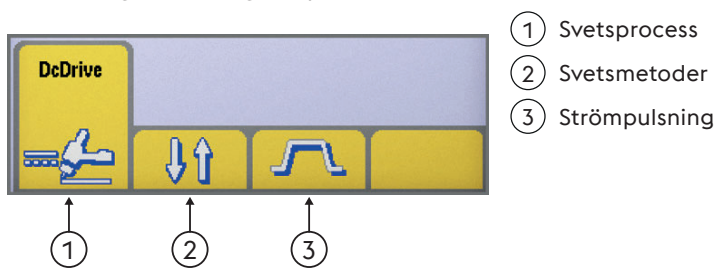

Svetsprocess

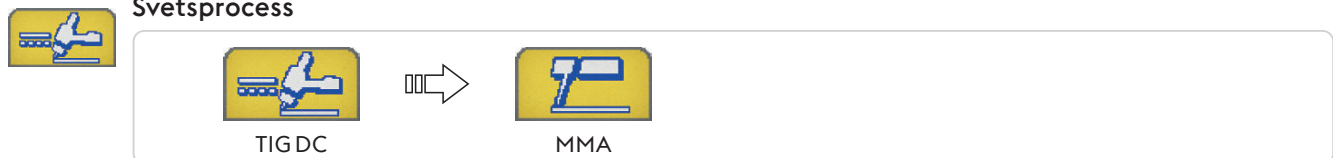

Svetsmetoder

Medger val av svetsmetod
2 steg
Vid 2 steg, får knapptryckningen gasen att flöda och tändar bågen. När knappen släpps återgår strömmen till noll under nedramptiden. När bågen slocknar fortsätter gasen att flöda under eftergastiden.

SV



4 steg

I 4 steg får den första knapptryckningen gasen att flöda vilket ger en manuell förgas. När den släpps tänds bågen.



Bilevel

I läge bilevel kan svetsaren svetsa med två olika förinställda strömmar. Första knapptryckningen ger förgastiden, tändningen av bågen och svetsning med startströmmen. Första gången knappen släpps leder till strömmens uppramp "I1". Om svetsaren trycker och släpper knappen snabbt ändras läget till "I2". Om knappen trycks ner och släpps snabbt återgår läget till "I2" och så vidare. Om man håller knappen nedtryckt under en längre tid startar nedrampen som minskar strömmen ned till slutvärdet. När knappen släpps släcks bågen medan gasen fortsätter att flöda under eftergastiden.



Strömpulsning



Konstantström



Pulsad ström



Fast Pulse



EasyArc

4.5 programvalsskärmen



Medger lagring och hantering av 240 jobb som kan anpassas till den enskilda användaren.

Program (JOB)

Se avsnittet "Huvudskärmen"

Programlagring

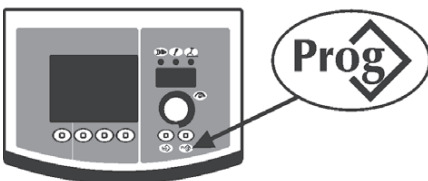

► Gå till programlagringsmenyn genom att hålla in knappen  i minst 1 sekund.

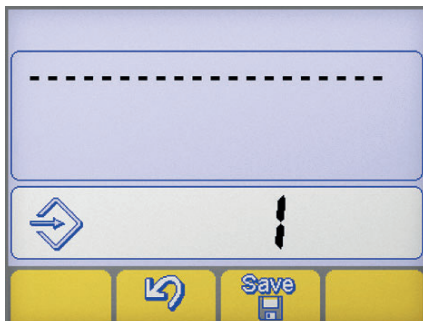

► Välj önskat program (eller tomt minne) genom att vrida på kodningsvredet.

--- Minnet tomt

 **Programmet sparat**

► Bekräfta åtgärden genom att trycka på knappen .

► Spara alla aktuella inställningar till det valda programmet genom att trycka på knappen .

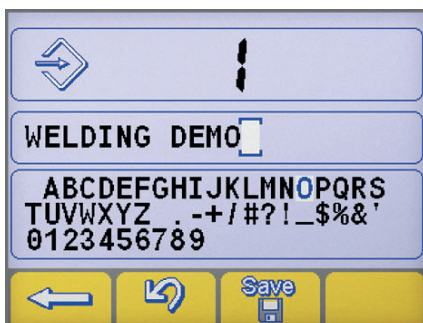



Lägg in en beskrivning av programmet.

► Välj önskad bokstav genom att vrida på kodningsvredet.

► Spara vald bokstav genom att trycka på kodningsvredet.

► Ta bort den sista bokstaven genom att trycka på knappen .

► Bekräfta åtgärden genom att trycka på knappen .

► Bekräfta åtgärden genom att trycka på knappen .



Om man vill spara ett nytt program på en minnesplats som redan är full måste man radera platsen genom en obligatorisk metod.



- ▶ Bekräfta åtgärden genom att trycka på knappen
- ▶ Ta bort det valda programmet genom att trycka på knappen
- ▶ Fortsätt med lagringsmetoden.

Hämtning av program

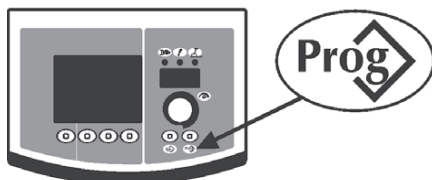

- ▶ Hämta det första tillgängliga programmet genom att trycka på knappen
- ▶ Välj önskat program genom att vrida på kodningsvredet.
- ▶ Välj önskat program genom att trycka på knappen
- Endast de minnesplatser där program är sparade hämtas medan tomma plaster automatiskt hoppas över.

Radering av program



- ▶ Välj önskat program genom att vrida på kodningsvredet.
- ▶ Ta bort det valda programmet genom att trycka på knappen
- ▶ Bekräfta åtgärden genom att trycka på knappen



- ▶ Bekräfta åtgärden genom att trycka på knappen
- ▶ Ta bort det valda programmet genom att trycka på knappen

SV

5. SETUP

5.1 Set-up och ställa in parametrar

För inställning av en rad tilläggsparametrar som ger en bättre och mer precis hantering av svetsanläggningen. De set-upparametrar som visas är anpassade efter den valda svetsningen och har numeriska koder.

Att öppna set-up





- ▶ Tryck på encodern i 5 sekunder.
- ▶ Åtkomsten bekräftas av att det står 0 på displayen.

Att välja och ställa in önskad parameter

- ▶ Tryck på dataomvandlaren tills den numeriska koden för den önskade parametern visas.
- ▶ Tryck sedan på dataomvandlarknappen för att visa det inställda värdet för den valda parametern och ändra inställningen.

Att stänga set-up

- ▶ Tryck på dataomvandlaren igen för att gå ur "inställningssektionen".
- ▶ Gå till parametern "0" (spara och stäng) och tryck på dataomvandlarknappen för att gå ur set-up.
- ▶ Bekräfta åtgärden genom att trycka på knappen .
- ▶ Spara ändringen och gå ur set-up genom att trycka på knappen: .

5.1.1 Set-upparametrar (MMA)

0 Spara och stäng



För att spara ändringarna och gå ur set-up.

1 Återställning



För att återställa alla parametrarna till standardvärdena.

3 Hot start



För inställning av hot start-procenten vid MMA-svetsning.

För inställning av mer eller mindre "het" start för att underlätta tändningen av bågen.

Basisk elektrode

Minimum	Maximum	Standard
0/af	500%	80%

Cellulose elektrode

Minimum	Maximum	Standard
0/af	500%	150%

CrNi-elektrode

Minimum	Maximum	Standard
0/af	500%	100%

Aluminium elektrode

Minimum	Maximum	Standard
0/af	500%	120%

Gjutjärn elektrode

Minimum	Maximum	Standard
0/af	500%	100%

Rutilelektrod

Minimum	Maximum	Standard
0/af	500%	80%

7 Svetsström

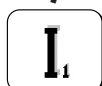

För inställning av svetsströmmen.

Minimum	Maximum	Standard
3 A	I _{max}	100 A

8 Arc force



För inställning av arc force-procenten vid MMA-svetsning.

Ger ett mer eller mindre energirikt dynamiskt svar under svetsningen för att underlätta svetsarens arbete.

Ökning av bågeffekten minskar risken för att elektroden ska fastna.

Basisk elektrode

Minimum	Maximum	Standard
0/af	500%	30%

Cellulose elektrode

Minimum	Maximum	Standard
0/af	500%	350%

CrNi-elektrode

Minimum	Maximum	Standard
0/af	500%	30%

Aluminium elektrode

Minimum	Maximum	Standard
0/af	500%	100%

Gjutjärn elektrode

Minimum	Maximum	Standard
0/af	500%	70%

Rutilelektrod

Minimum	Maximum	Standard
0/af	500%	80%

204 Dynamic power control (DPC)



Möjliggör val av önskad V/I-karakteristik.

I=C Konstantström

Ökning eller minskning av båg höjden har ingen effekt på den svetsström som krävs.

Rekommenderas för elektrod: Basisk, Rutil, Sur, Stål, Gjutjärn

1:20 Minskande gradientkontroll

Ökningen av båg höjden orsakar en sänkning av svetsströmmen (och omvänt) enligt det värde som ges av 1 till 20 ampere per volt.

Rekommenderas för elektrod: Cellulosa, Aluminium

P=C Konstanteffekt

Ökningen av båg höjden orsakar en sänkning av svetsströmmen (och omvänt) enligt formeln: $V \cdot I = K$

Rekommenderas för elektrod: Cellulosa, Aluminium

312 Spänning för att bryta bågen



För inställning av det spänningsvärde vid vilket den elektriska bågen ska brytas.

Används för att hantera de olika driftsförutsättningar som uppstår på bästa sätt.

Vid punktsvetsning blir till exempel den uppflammande lågan när elektroden tas bort från arbetsstycket mindre om bågen bryts vid en låg spänning, vilket innebär att det blir mindre stänk, brännskador och oxidation på arbetsstycket.



Ställ aldrig in en högre spänning för att bryta bågen än generatorns tomgångsström.

Basisk elektrode

Minimum	Maximum	Standard
0/af	Vmax	57.0 V

Cellulose elektrode

Minimum	Maximum	Standard
0/af	Vmax	70.0 V

399 Skärningshastighet



Medger inställning av svetsningshastighet.

Default cm/min: referenshastighet för manuell svetsning.

Syn: Sinergic värde.

Minimum	Maximum	Standard
2 cm/min	200 cm/min	15 cm/min

500 Maskininställning



Här kan man välja grafiskt gränssnitt.

Ger åtkomst till de högre inställningsnivåerna.

Se avsnittet "Anpassning av gränssnittet (Set up 500)"

Värde	Vald nivå
USER	Användare
SERV	Service
vaBW	vaBW

Värde	Användargränssnitt
XE	Driftsättet Easy
XA	Driftsättet Advanced
XP	Driftsättet Professional

551 Lock/unlock



Medger spärning av manöverpanelen och inmatning av en skyddskod.

Se avsnittet "Lock/unlock (Set up 551)".

552 Ljudsignal



För inställning av ljudsignalen.

Minimum	Maximum	Standard
0/af	10	10

601 Inställningssteg



Medger inställning av en parameter med ett steg som användaren kan bestämma själv.

Minimum	Maximum	Standard
1	Imax	1

602 Extern parameter 2



Här kan man ställa in den externa parametern 2 (minsta värde, största värde, förinställt värde, vald parameter).

705 Kalibrering av kretsmotstånd

Används för kalibrering av aggregatet.
 Se avsnittet "Kalibrering av kretsmotstånd (set up 705)".

751 Strömstyrka

Medger visning av den faktiska svetsströmmen.

752 Spänning

Medger visning av den faktiska svetsspänningen.

768 Mätning av värmetillskott HI

Används för avläsning av mätvärdet för värmetillskott vid svetsningen.

5.1.2 Lista över inställda parametrar (TIG)
0 Spara och stäng

För att spara ändringarna och gå ur set-up.

1 Återställning

För att återställa alla parametrarna till standardvärdena.

2 För-gas

För att ställa in och reglera gasflödet innan bågen tänds.
 Gör det möjligt att ladda gasen i brännaren och förbereda miljön för svetsningen.

Minimum	Maximum	Standard
0/af	99.9 s	0.1 s

3 Startström

Möjliggör ändring av svetsens startström.
 Möjliggör varmare eller kallare svetsställe direkt efter bågändringen.

Minimum	Maximum	Standard	Minimum	Maximum	Standard
1%	200%	50%	3 A	I _{max}	-

5 Startströmtid

Här kan man ställa in hur länge startströmmen ska bibehållas.

Minimum	Maximum	Standard
0/af	99.9 s	0/af

6 Uppramp

För inställning av en stegvis övergång mellan begynnelseströmmen och svetsströmmen.

Minimum	Maximum	Standard
0/af	99.9 s	0/af

7 Svetsström

För inställning av svetsströmmen.

Minimum	Maximum	Standard
3 A	I _{max}	100 A

8 Bilevel-ström



För inställning av sekundärströmmen vid bilevel-svetsning.

Första gången man trycker på brännarknappen kommer förgasen, bågen tänds och svetsning sker med begynnelseströmmen.

Första gången knappen släpps upp startar upprampen för "I1"-strömmen.

Om man trycker på knappen och snabbt släpper den igen övergår strömmen till "I2".

Tryck på knappen och släpp den genast för att gå tillbaka till "I1", och vice versa för "I2".

Om man håller knappen nedtryckt under en längre tid startar nedrampen som minskar strömmen ned till slutvärdet.

När knappen släpps upp slocknar bågen och gasen fortsätter att flöda ut under eftergas-fasen.

Minimum	Maximum	Standard
3 A	I _{max}	-

Minimum	Maximum	Standard
1%	500%	af

10 Basström



För inställning av basströmmen vid svetsning med pulserande ström och snabb pulserande ström.

Minimum	Maximum	Standard
3 A	I _{sald}	-

Minimum	Maximum	Standard
1%	100%	50%

12 Pulsfrekvens



Tillåter reglering av pulsfrekvensen.

Möjliggör bättre resultat vid svetsning av tunna material och bättre utseende hos strängen.

Minimum	Maximum	Standard
0.1 Hz	25 Hz	5 Hz

13 Pulsdriftcykel



Gör att man kan reglera arbetscykeln vid pulssvetsning.

Gör att strömtoppen kan bibehållas kortare eller längre tid.

Minimum	Maximum	Standard
1 %	99 %	50 %

14 Snabb pulsfrekvens



Tillåter reglering av pulsfrekvensen.

Gör att man kan fokusera och få bättre stabilitet hos bågen.

Minimum	Maximum	Standard
0.02 KHz	2.5 KHz	0.25 KHz

15 Pulsramper



Inställning av stegrings- eller minskningstid under pulssvetsning.

Ger mjuk övergång mellan strömtoppen och grundströmmen med en mer eller mindre mjuk svetsbåge.

Minimum	Maximum	Standard
0/af	100 %	0/af

16 Nedramp



För inställning av en stegvis övergång mellan svetsströmmen och slutströmmen.

Minimum	Maximum	Standard
0/af	99.9 s	0/af

17 Slutström



För inställning av slutströmmen.

Minimum	Maximum	Standard
3 A	I _{max}	10 A

Minimum	Maximum	Standard
1 %	200 %	50 %

19 Slutströmstid



Gör det möjligt att ställa in hur länge utgångsströmmen bibehålls.

Minimum	Maximum	Standard
0/af	99.9 s	0/af

20 Efter-gas



För inställning av gasflödet vid slutet av svetsningen.

Minimum	Maximum	Standard
0/af	99.9 s	syn

203 Tig start (HF)

Gör att man kan välja bland bågändningslägena.

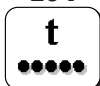
Värde	Standard	Återuppringsfunktion
on	X	HF START
af	-	LIFT START

204 Punktsvetsning

Gör att du kan aktivera punktsvetsningsprocessen och bestämma svetsningstiden.

Här kan man ställa in tiden för svetsningsprocessen.

Minimum	Maximum	Standard
0/af	99.9 s	0/af

205 Restart

Här aktiveras omstartsfunktionen.

Gör att man kan släcka bågen omedelbart under minskningsfasen eller starta om svetscykeln.

Värde	Standard	Återuppringsfunktion
0/af	-	af
1/on	X	on
2/of1	-	af

206 Easy joining

Möjliggör bågändning vid pulsström och tidsinställning av funktionen före automatisk återaktivering av de förinställda svetsförhållandena.

Ger högre hastighet och exakthet under häftsvetsning på delarna.

Minimum	Maximum	Standard
0.1 s	25.0 s	0/af

208 Microtime spot welding

För inkoppling av "microtime spot welding".

Här kan man ställa in tiden för svetsningsprocessen.

Minimum	Maximum	Standard
0.01 s	1.00 s	0/af

399 Skärningshastighet

Medger inställning av svetsningshastighet.

Default cm/min: referenshastighet för manuell svetsning.

Syn: Sinergic värde.

Minimum	Maximum	Standard
2 cm/min	200 cm/min	10 cm/min

500 Maskininställning

Här kan man välja grafiskt gränssnitt.

Ger åtkomst till de högre inställningsnivåerna.

Se avsnittet "Anpassning av gränssnittet (Set up 500)"

Värde	Vald nivå	Värde	Användargränssnitt
USER	Användare	XE	Driftsättet Easy
SERV	Service	XA	Driftsättet Advanced
vaBW	vaBW	XP	Driftsättet Professional

551 Lock/unlock

Medger spärrning av manöverpanelen och inmatning av en skyddskod.

Se avsnittet "Lock/unlock (Set up 551)".

552 Ljudsignal



För inställning av ljudsignalen.

Minimum	Maximum	Standard
0/af	10	10

601 Inställningssteg



Medger inställning av en parameter med ett steg som användaren kan bestämma själv.

Minimum	Maximum	Standard
1	Imax	1

602 Extern parameter CH1, CH2, CH3, CH4



Här kan man ställa in den externa parametern 1, 2, 3, 4 (minsta värde, största värde, förinställt värde, vald parameter).

Se avsnittet "Hantering av externa styrkommandon (Set up 602)".

606 U/D-brännare



Här kan man ställa in den externa parametern (U/D).

Värde	Standard	Återuppringsfunktion
0/af	-	af
1/11	X	Ström
	-	Hämtning av program

612 Brännarinställning DgTig



Används för att styra den digitala brännarens kanaler.

Värde	Standard	Återuppringsfunktion
0/af	-	af
1/11	-	Ström
2/	-	Hämtning av program
3/CH3	-	CH3
4/CH4	-	CH4
5/STD	X	STD

705 Kalibrering av kretsmotstånd



Används för kalibrering av aggregatet.

Se avsnittet "Kalibrering av kretsmotstånd (set up 705)".

751 Strömstyrka



Medger visning av den faktiska svetsströmmen.

752 Spänning



Medger visning av den faktiska svetsspänningen.

758 Robothastighet



Medger avläsning av hur fort armen på en robot eller en automatiserad enhet rör sig.

764 Kylmedelsflöde



Medger visning av den kylmedelsflöde.

SV

765 Avläsning kylmedelstemperatur

Medger visning av den kylmedelstemperatur.

768 Mätning av värmetillskott HI

Används för avläsning av mätvärdet för värmetillskott vid svetsningen.

801 Säkerhetsgränser

Medger inställning av varnings- och säkerhetsgränser.

Medger styrning av svetsprocessen med hjälp av varningsgränser och säkerhetsgränser för de viktigaste mätbara parametrarna.



För noggrann styrning av de olika svetsfaserna

5.2 Särskilda procedurer för användning av parametrar

5.2.1 Anpassning av 7-segmentsdisplayen

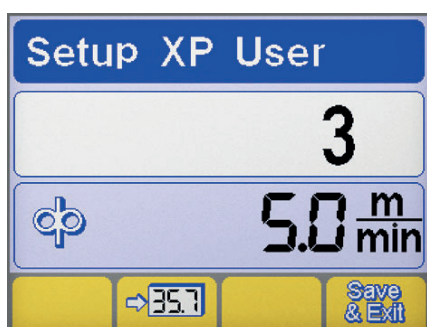
Används för att visa ett parametervärde konstant på 7-segmentsdisplayen.



- ▶ Gå till SetUp genom att hålla kodningsvredet intryckt under minst 5 sekunder.
- ▶ Välj önskad parameter genom att vrida på kodningsvredet.
- ▶ Lagra den valda parametern i 7-segmentsdisplayen genom att trycka på knappen .
- ▶ Spara och lämna skärmen genom att trycka på knappen .

5.2.2 Anpassning av gränssnittet (Set up 500)













Parametrarna kan anpassas i huvudmenyn.

500 Maskininställning









Här kan man välja grafiskt gränssnitt.

Värde	Användargränssnitt
XE	Driftssättet Easy
XA	Driftssättet Advanced
XP	Driftssättet Professional

DRIFTSÄTT XE

MMA	
Svetsparametrar	
TIG	
Svetsparametrar	    
Funktioner	      

DRIFTSÄTT XA

MMA	
Svetsparametrar	  
Funktioner	    

TIG

Svetsparametrar								
Funktioner								

DRIFTSÄTT XP

MMA

Svetsparametrar					
Funktioner					

TIG

Svetsparametrar											
Funktioner											

5.2.3 Lock/unlock (Set up 551)

Medger spärrning av manöverpanelen och inmatning av en skyddskod.

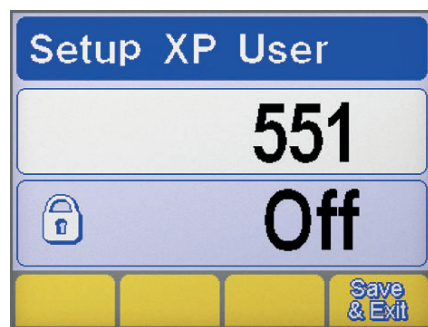

Val av parameter

- ▶ Gå till SetUp genom att hålla kodningsvredet intryckt under minst 5 sekunder.
- ▶ Välj parameter (551).
- ▶ Aktivera inställning av vald parameter genom att trycka på kodningsknappen.

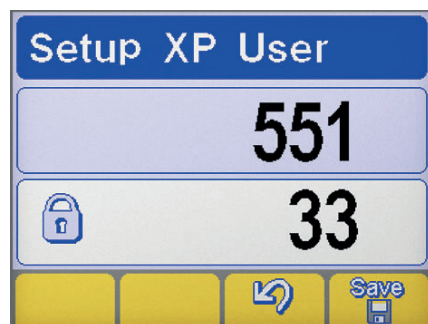

Inställning av lösenord

- ▶ Ställ in en numerisk kod (ett lösenord) genom att vrida på kodningsvredet.
- ▶ Bekräfta momentet genom att trycka på encoderknappen.
- ▶ Bekräfta åtgärden genom att trycka på knappen
- ▶ Spara ändringen genom att trycka på knappen:

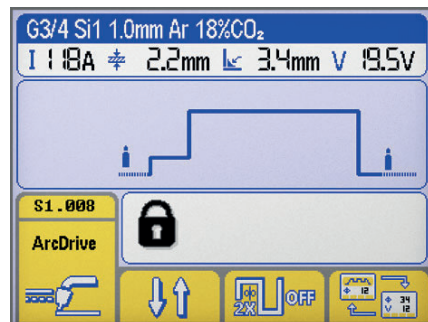

Panelfunktioner



Om man försöker göra någon åtgärd via en spärrad manöverpanel visas en specialsärm.

- ▶ Gå till panelfunktionerna tillfälligt (under 5 minuter) genom att vrida på kodningsvredet och mata in lösenordet (koden).
- ▶ Bekräfta momentet genom att trycka på encoderknappen.
- ▶ Manöverpanelen frisläpps permanent om man går till Set-up (se anvisningarna ovan) och ändrar parameter 551 till OFF.
- ▶ Bekräfta momentet genom att trycka på encoderknappen.
- ▶ Spara ändringen genom att trycka på knappen:

SV

5.2.4 Hantering av externa styrkommandon (Set up 602)

Här kan man ställa in den externa parametern 2 (minsta värde, största värde, förinställt värde, vald parameter).

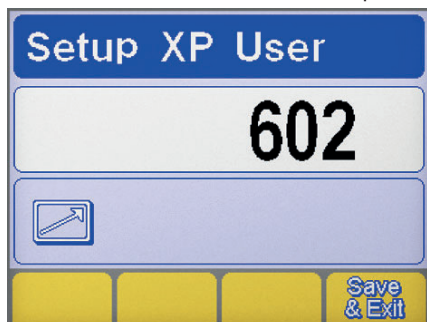

Val av parameter

- ▶ Gå till SetUp genom att hålla kodningsvredet intryckt under minst 5 sekunder.
- ▶ Välj parameter (602).
- ▶ Gå till skärmen "Hantering av externa styrkommandon" genom att trycka på kodningsvredet.

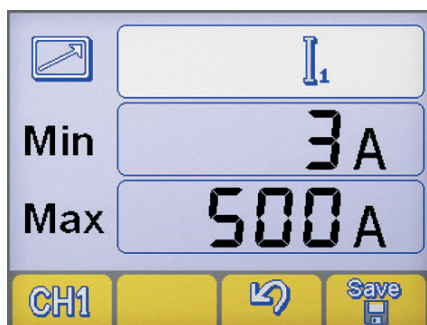

Hantering av externa styrkommandon

- ▶ Välj RC-fjärrkontrollutgång (CH1, CH2, CH3, CH4) genom att trycka på knappen **CH1**.
- ▶ Välj önskad parameter (MIN-MAX-parameter) genom att trycka på kodningsvredet.
- ▶ Ställ in värdet på önskad parameter (MIN-MAX-parameter) genom att vrida på kodningsvredet.
- ▶ Spara ändringen genom att trycka på knappen: **Save**.
- ▶ Bekräfta åtgärden genom att trycka på knappen **↵**.

5.2.5 Kalibrering av kretsmotstånd (set up 705)

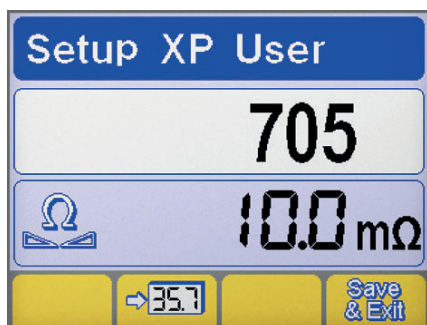

Val av parameter

- ▶ Gå till SetUp genom att hålla kodningsvredet intryckt under minst 5 sekunder.
- ▶ Välj parameter (705).
- ▶ Aktivera inställning av vald parameter genom att trycka på kodningsknappen.

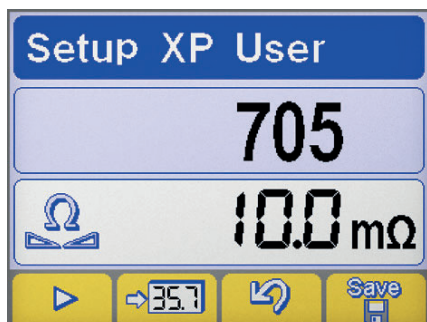

Kalibrering

- ▶ Sätt volframelektrode i elektrisk kontakt med arbetsstycket. (TIG)
- ▶ Placera elektrodhållarens brännare och stycket som ska svetsas i kontakt. (MMA)
- ▶ Tryck på knappen **▶** (eller brännarknappen) för att börja proceduren.
- ▶ Upprätthåll kontakten i minst 1 sekund.
- ▶ Värdet som visas på displayen uppdateras efter kalibreringen.
- ▶ Bekräfta åtgärden genom att trycka på knappen **Save**.
- ▶ Bekräfta åtgärden genom att trycka på knappen **↵**.
- ▶ Spara ändringen och gå ur set-up genom att trycka på knappen: **Save & Exit**.

5.2.6 Säkerhetsgränser (Set up 801)

Medger inställning av varnings- och säkerhetsgränser.

Medger styrning av svetsprocessen med hjälp av varningsgränser och säkerhetsgränser för de viktigaste mätbara parametrarna.

För noggrann styrning av de olika svetsfaserna

Se avsnittet "Säkerhetsgränser (Set up 801)".



I Svetsström

V Arbetspänning

⚡ Avläsning av gasflödet

↗ Robothastighet

SV



Strömstyrka (motor 1)



Strömstyrka (motor 2)



Kylmedelsflöde



Tråd hastighet



Avläsning kylmedelstemperatur

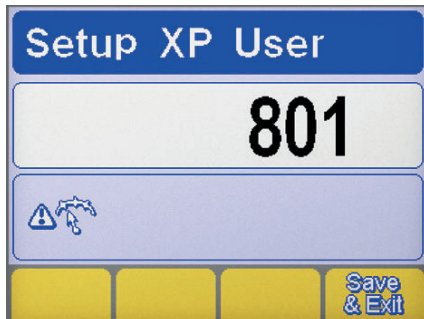

Val av parameter

- ▶ Gå till SetUp genom att hålla kodningsvredet intryckt under minst 5 sekunder.
- ▶ Välj parameter (801).
- ▶ Gå till skärmen "Säkerhetsgränser" genom att trycka på kodningsvredet.

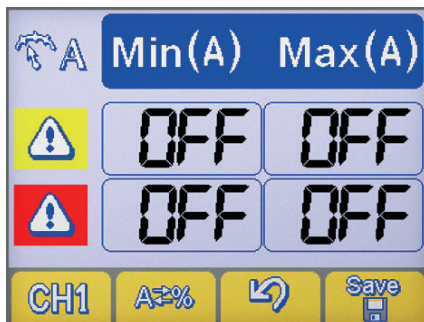

Val av parametern

- ▶ Välj önskad parameter genom att trycka på knappen **CH1**.
- ▶ Välj metod för inställning av säkerhetsgränserna genom att trycka på knappen **A=%**.



Maskininställning



Absolutvärde



Procentvärde

Inställning av larmgränser

- 1 Rad för varningsgränser
- 2 Rad för larmgränser
- 3 Spalt för lägsta nivå
- 4 Spalt för högsta nivå

- ▶ Välj önskat fält genom att trycka på kodningsvredet (det valda fältet markeras genom omvänd kontrast).
- ▶ Modifiera värdet på den valda gränsen genom att vrida på kodningsvredet.
- ▶ Spara ändringen genom att trycka på knappen: **Save**.



När en varningsgräns passeras avges en visuell varning på manöverpanelen.



När en larmgräns passeras visas ett visuellt larm på manöverpanelen och svetsprocessen avbryts.



Man kan ställa in filter för tändningen och släckningen av ljusbågen så att inga larm avges då (se avsnittet "Set Up" - Parametrarna 802-803-804).

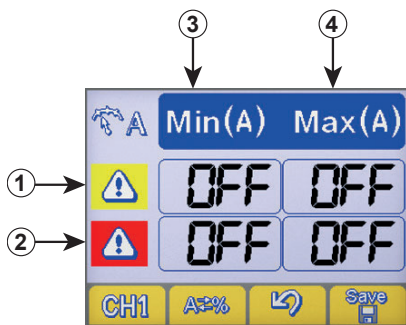

6. UNDERHÅLL



Anläggningen ska genomgå löpande underhåll i enlighet med tillverkarens instruktioner. Alla luckor och kåpor ska vara stängda och ordentligt fastsatta när apparaten är i drift. Aggregatet får inte modifieras på något sätt. Om detta underhåll inte utförs upphör alla garantier att gälla och tillverkaren kan inte utkrävas något ansvar för konsekvenserna.



Eventuellt underhåll får endast utföras av utbildad personal. Om obehörig personal reparerar aggregatet eller byter ut delar av det upphör produktgarantin omedelbart att gälla. Eventuella reparationer och utbyte av delar av aggregatet får endast utföras av kompetent teknisk personal.



Stäng av strömförsörjningen till aggregatet före alla ingrepp!

6.1 Periodiska kontroller av generatorn

6.1.1 Urządzenie



Rengör generatorn invändigt med tryckluft med lågt tryck och pensel med mjuk borst. Kontrollera de elektriska anslutningarna och alla kabelkopplingar.

6.1.2 Underhåll eller utbyte av komponenter i brännarna, elektrodhållaren och/eller jordledningen:



Kontrollera komponenternas temperatur och att de inte är överhettade.



Använd alltid handskar som uppfyller kraven i regler och bestämmelser.



Använd lämpliga nycklar och verktyg.

6.2 Odpowiedzialność



Om detta underhåll inte utförs upphör alla garantier att gälla och tillverkaren kan inte utkrävas något ansvar för konsekvenserna. Tillverkaren påtar sig inget ansvar om operatören inte följer dessa anvisningar. Kontakta närmaste serviceverkstad vid tveksamheter och/eller problem.

7. LARMKODER



LARM





















Om ett larm utlöses eller en kritisk övervakningsgräns överskrids visas en ljussignalering på kontrollpanelen och svetsningen blockeras omedelbart.



























OBS

Om en larmgräns överskrids visas en ljussignalering på kontrollpanelen men svetsningen behöver inte avbrytas.

Nedan listas samtliga larm och övervakningsgränser för systemet.

 E01	Överhettning		 E02	Överhettning	
 E03	Överhettning		 E05	Överström	
 E06	Överström hos effektmodul (Boost)		 E07	Fel på systemet för strömförsörjning av trådmatningens motor	
 E08	Blockerad motor		 E10	Överström hos effektmodul (Inverter)	
 E11	Fel systemkonfiguration		 E13	Kommunikationsfel (FP)	

 E14.xx	Ogiltigt program felets underkod anger det borttagna programnumret		 E15	Ogiltigt program	
 E16	Kommunikationsfel (RI) (Automation och robotteknik)		 E18.xx	Ogiltigt program felets underkod anger det borttagna programnumret	
 E19	Fel systemkonfiguration		 E20	Defekt minne	
 E21	Förlust av data		 E22	Kommunikationsfel (DSP)	
 E27	Defekt minne (RTC)		 E29	Inkompatibla mätvärden	
 E30	Kommunikationsfel (H.F.)		 E32	Förlust av data	
 E33	Fel systemkonfiguration (LCD 3.5")		 E38	Underspänning	
 E39	Fel strömförsörjning av aggregatet		 E40	Fel strömförsörjning av aggregatet	
 E41	Överspänning		 E42	Underspänning	
 E43	Saknas kylvätska		 E49	Nödbrytare (Automation och robotteknik)	
 E51	Inställningarna understöds inte (Automation och robotteknik)		 E52	Kollisionsskydd (Automation och robotteknik)	
 E53	Fel på extern flödesvakt (Automation och robotteknik)		 E54	Överskriden strömnivå (Nedre gräns)	
 E55	Överskriden strömnivå (Övre gräns)		 E56	Överskriden spänningsnivå (Nedre gräns)	
 E57	Överskriden spänningsnivå (Övre gräns)		 E58	Överskriden flödesnivå för gas (Nedre gräns)	
 E59	Överskriden flödesnivå för gas (Övre gräns)		 E62	Överskriden strömnivå (Nedre gräns)	
 E63	Överskriden strömnivå (Övre gräns)		 E64	Överskriden spänningsnivå (Nedre gräns)	
 E65	Överskriden spänningsnivå (Övre gräns)		 E66	Överskriden flödesnivå för gas (Nedre gräns)	

 E67	Överskriden flödesnivå för gas (Övre gräns)		 E71	Överhettad kylvätska	
 E72	Överström hos push-pull-motor		 E73	Överskriden trådhastighetsgräns (speed meter)	
 E75	Överskriden strömnivå för motor 2		 E76	Överskriden flödesnivå för kylvätska	
 E77	Temperaturnivå för kylvätska		 E78	Aktivt underhåll (Automation och robotteknik)	
 E81	Överström (pump WU)		 E82	Kommunikationsfel (WU)	
 E83	Blockerad pump		 E99	Allmänt larm	

8. FELSÖKNING OCH TIPS

Aggregatet startar inte (den gröna kontrolllampan är släckt)

Orsak

- » Ingen nätspänning i strömförsörjningsuttaget.
- » Fel på stickpropp eller elsladd.
- » Linjesäkringen har gått.
- » Fel på huvudströmbrytaren.
- » Elektroniskt fel.

Lösning

- » Kontrollera och reparera elsystemet.
- » Vänd dig till specialutbildad personal.
- » Byt ut den skadade komponenten.
- » Kontakta närmaste serviceverkstad för reparation av aggregatet.
- » Byt ut den skadade komponenten.
- » Byt ut den skadade komponenten.
- » Kontakta närmaste serviceverkstad för reparation av aggregatet.
- » Kontakta närmaste serviceverkstad för reparation av aggregatet.

Ingen uteffekt (aggregatet svetsar inte)

Orsak

- » Fel på brännarknappen.
- » Aggregatet är överhettat (överhettningsskydd - den gula kontrolllampan lyser).
- » Felaktig jordning.
- » Matarspänningen ligger utanför tillåtet intervall (den gula kontrolllampan lyser).
- » Fel på fjärrströmställare.
- » Elektroniskt fel.

Lösning

- » Byt ut den skadade komponenten.
- » Kontakta närmaste serviceverkstad för reparation av aggregatet.
- » Vänta tills aggregatet svalnar utan att stänga av det.
- » Jorda aggregatet ordentligt.
- » Se avsnittet "Igångsättning".
- » Se till att nätspänningen håller sig inom intervallet för matning av aggregatet.
- » Anslut aggregatet enligt anvisningarna.
- » Se avsnittet "Anslutning".
- » Byt ut den skadade komponenten.
- » Kontakta närmaste serviceverkstad för reparation av aggregatet.
- » Kontakta närmaste serviceverkstad för reparation av aggregatet.

Felaktig uteffekt

Orsak

- » Felaktig inställning av svetsningen eller fel på väljaren.
- » Felaktig inställning av parametrar och funktioner för aggregatet.

Lösning

- » Gör om inställningarna för svetsningen.
- » Återställ aggregatet och ställ in parametrarna för svetsningen igen.

- | | |
|--|--|
| <ul style="list-style-type: none"> » Fel på potentiometer/dataomvandlare för inställning av svetsström. | <ul style="list-style-type: none"> » Byt ut den skadade komponenten. |
| <ul style="list-style-type: none"> » Matarspänningen ligger utanför tillåtet intervall. | <ul style="list-style-type: none"> » Kontakta närmaste serviceverkstad för reparation av aggregatet. |
| <ul style="list-style-type: none"> » En fas saknas. | <ul style="list-style-type: none"> » Anslut aggregatet enligt anvisningarna. » Se avsnittet "Anslutning". |
| <ul style="list-style-type: none"> » Elektroniskt fel. | <ul style="list-style-type: none"> » Anslut aggregatet enligt anvisningarna. » Se avsnittet "Anslutning". » Kontakta närmaste serviceverkstad för reparation av aggregatet. |

Instabil båge

Orsak

- » Otillräcklig skyddsgas.
- » Fukt i svetsgasen.
- » Felaktiga parametrar för svetsningen.

Lösning

- » Justera gasflödet.
- » Kontrollera att brännarens diffusor och munstycke är i gott skick.
- » Använd alltid produkter och material med hög kvalitet.
- » Se till att systemet för gasförsörjning hålls i perfekt skick.
- » Kontrollera svetsaggregatet noggrant.
- » Kontakta närmaste serviceverkstad för reparation av aggregatet.

Mycket stänk

Orsak

- » Felaktig båglängd.
- » Felaktiga parametrar för svetsningen.
- » Otillräcklig skyddsgas.
- » Felaktig bågdynamik.
- » Felaktigt utförd svetsning.

Lösning

- » Minska avståndet mellan elektroden och arbetsstycket.
- » Minska arbetsspänningen.
- » Minska arbetsspänningen.
- » Justera gasflödet.
- » Kontrollera att brännarens diffusor och munstycke är i gott skick.
- » Öka induktansen i kretsen.
- » Minska brännarens lutning.

Otillräcklig inträngning

Orsak

- » Felaktigt utförd svetsning.
- » Felaktiga parametrar för svetsningen.
- » Felaktig elektrod.
- » Felaktig förberedelse av kanterna.
- » Felaktig jordning.
- » Stora arbetsstycken som ska svetsas.

Lösning

- » Sänk frammatningshastigheten för svetsning.
- » Öka svetsströmmen.
- » Använd en elektrod med mindre diameter.
- » Öka diktjärnets öppning.
- » Jorda aggregatet ordentligt.
- » Se avsnittet "Igångsättning".
- » Öka svetsströmmen.

Slagginneslutningar

Orsak

- » Otillräcklig slaggborttagning.
- » För stor elektroddiameter.
- » Felaktig förberedelse av kanterna.
- » Felaktigt utförd svetsning.

Lösning

- » Rengör arbetsstyckena ordentligt innan svetsningen.
- » Använd en elektrod med mindre diameter.
- » Öka diktjärnets öppning.
- » Minska avståndet mellan elektroden och arbetsstycket.
- » Arbeta jämnt under alla svetsningsfaserna.

Volframminneslutningar

Orsak

- » Felaktiga parametrar för svetsningen.
- » Felaktig elektrod.
- » Felaktigt utförd svetsning.

Lösning

- » Minska arbetsspänningen.
- » Använd en elektrod med större diameter.
- » Använd alltid produkter och material med hög kvalitet.
- » Slipa elektroden enligt anvisningarna.
- » Undvik kontakt mellan elektroden och smältbadet.

Blåsor

Orsak	Lösning
» Otillräcklig skyddsgas.	» Justera gasflödet. » Kontrollera att brännarens diffusor och munstycke är i gott skick.

Ingen sammansmältning

Orsak	Lösning
» Felaktig båglängd.	» Öka avståndet mellan elektroden och arbetsstycket. » Öka arbetsspänningen.
» Felaktiga parametrar för svetsningen.	» Öka svetsströmmen. » Öka arbetsspänningen.
» Felaktigt utförd svetsning.	» Öka brännarens lutning.
» Stora arbetsstycken som ska svetsas.	» Öka svetsströmmen. » Öka arbetsspänningen.
» Felaktig bågdyamik.	» Öka induktansen i kretsen.

Sidoskårer

Orsak	Lösning
» Felaktiga parametrar för svetsningen.	» Minska arbetsspänningen. » Använd en elektrod med mindre diameter.
» Felaktig båglängd.	» Minska avståndet mellan elektroden och arbetsstycket. » Minska arbetsspänningen.
» Felaktigt utförd svetsning.	» Sänk oscillationshastigheten i sidled under fyllningen. » Sänk frammatningshastigheten för svetsning.
» Otillräcklig skyddsgas.	» Använd gas som lämpar sig för det material som ska svetsas.

Oxidering

Orsak	Lösning
» Otillräcklig skyddsgas.	» Justera gasflödet. » Kontrollera att brännarens diffusor och munstycke är i gott skick.

Porositet

Orsak	Lösning
» Fett, färg, rost eller smuts på de arbetsstycken som ska svetsas.	» Rengör arbetsstyckena ordentligt innan svetsningen.
» Fett, färg, rost eller smuts på svetsmaterialet.	» Använd alltid produkter och material med hög kvalitet. » Håll alltid svetsmaterialet i perfekt skick.
» Fukt i svetsmaterialet.	» Använd alltid produkter och material med hög kvalitet. » Håll alltid svetsmaterialet i perfekt skick.
» Felaktig båglängd.	» Minska avståndet mellan elektroden och arbetsstycket. » Minska arbetsspänningen.
» Fukt i svetsgasen.	» Använd alltid produkter och material med hög kvalitet. » Se till att systemet för gasförsörjning hålls i perfekt skick.
» Otillräcklig skyddsgas.	» Justera gasflödet. » Kontrollera att brännarens diffusor och munstycke är i gott skick.
» Smältbadet stelnar för snabbt.	» Sänk frammatningshastigheten för svetsning. » Värm upp de arbetsstycken som ska svetsas i förväg. » Öka svetsströmmen.

Varmsprickor

Orsak	Lösning
» Felaktiga parametrar för svetsningen.	» Minska arbetsspänningen. » Använd en elektrod med mindre diameter.
» Fett, färg, rost eller smuts på de arbetsstycken som ska svetsas.	» Rengör arbetsstyckena ordentligt innan svetsningen.

- » Fett, färg, rost eller smuts på svetsmaterialet.
- » Felaktigt utförd svetsning.
- » Arbetsstycken med olika egenskaper.
- » Använd alltid produkter och material med hög kvalitet.
- » Håll alltid svetsmaterialet i perfekt skick.
- » Utför rätt driftsmoment för den fog som ska svetsas.
- » Buttra innan svetsningen.

Kallsprickor

Orsak

- » Fukt i svetsmaterialet.
- » Speciell form på den fog som ska svetsas.

Lösning

- » Använd alltid produkter och material med hög kvalitet.
- » Håll alltid svetsmaterialet i perfekt skick.
- » Värm upp de arbetsstycken som ska svetsas i förväg.
- » Värm upp arbetsstyckena efteråt.
- » Utför rätt driftsmoment för den fog som ska svetsas.

9. ARBETSINSTRUKTIONER

9.1 Svetsning med belagd elektrod (MMA)

Förberedelse av kanterna

För bästa resultat bör man alltid arbeta med rena delar, utan oxidering, rost eller andra förorenande ämnen.

Val av elektrod

Vilken diameter elektroden ska ha beror på materialets tjocklek, typ av fog och typ av diktjärn.

Elektroder med stor diameter fordrar hög strömstyrka vilket medför hög värmeutveckling under svetsningen.

Typ av beläggning	Egenskaper	Användning
Rutil	Lätthanterlighet	Alla positioner
Sur	Hög sammansmältningshastighet	Plan
Basisk	Mekaniska egenskaper	Alla positioner

Val av svetsström

Svetsströmsintervallen för den använda elektrodtypen framgår av elektrodförpackningen.

Att tända och bibehålla bågen

Den elektriska bågen skapas genom att man gnider elektrodspetsen mot det arbetsstycke som ska svetsas, vilket ska vara anslutet till jordledningen. När bågen har uppstått drar man snabbt tillbaka elektroden till normalt svetsningsavstånd.

För att förbättra tändningen är det i allmänhet lämpligt att öka strömstyrkan inledningsvis jämfört med den vanliga svetsströmmen (Hot Start).

När den elektriska bågen har bildats börjar elektrodens mittersta del smälta och lägger sig som droppar på arbetsstycket.

När elektrodens yttre beläggning förbrukas bildas skyddande gas som ger svetsningen hög kvalitet.

För att undvika att dropparna av smält material kortsluter elektroden med smältbadet om dessa av misstag kommer i kontakt med varandra och därmed släcker bågen kan man med fördel använda en tillfällig ökning av svetsströmmen till dess att kortslutningen har upphört (Arc Force).

Om elektroden fastnar i arbetsstycket bör man minska kortslutningsströmmen så mycket som möjligt (anti-sticking).

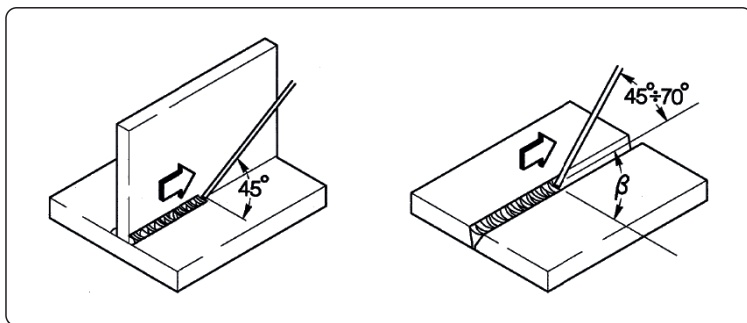

Svetsning

Elektrodens lutningsvinkel beror på antalet svetssträngar. Elektroden förs vanligen i en svängande rörelse med stopp vid ändarna av svetsstället för att undvika att för mycket svetsmaterial ansamlas i mitten.

Slaggborttagning

Vid svetsning med belagda elektroder tas slaggen bort efter varje svetssträng.

Borttagningen utförs med en liten hammare eller genom att borsta av lös slagg.

9.2 TIG-Svetsning (kontinuerlig båge)

Beskrivning

Principen bakom TIG-svetsning (Tungsten Inert Gas) är att en elektrisk båge bildas mellan en icke avsmältande elektrod (av ren volfram eller volframlegering med en smälttemperatur på cirka 3370 °C) och arbetsstycket. En skyddsgas (argon) skyddar smältbadet.

För att undvika farliga volframminneslutningar i fogen får elektroden aldrig komma i kontakt med arbetsstycket. Därför genereras en urladdning som tänder den elektriska bågen på avstånd med hjälp av en HF-generator.

Det finns också en annan tändningsmetod som ger mindre volframminneslutningar: s.k. lift-tändning. I stället för hög frekvens startar man med kortslutning med svag strömstyrka mellan elektroden och arbetsstycket. När elektroden sedan lyfts upp bildas bågen och strömstyrkan ökar upp till inställt värde.

För att den sista delen av svetssträngen ska få god kvalitet är det bra att kunna kontrollera minskningen av svetsströmmen med precision och det fordras att gasen flödar i smältbadet under några sekunder efter det att bågen har släckts.

I många driftssammanhang är det bra att ha 2 förinställda svetsströmmar och lätt kunna gå från den ena till den andra (BILEVEL).

Svetsningspolaritet

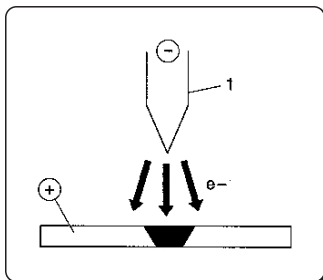

D.C.S.P. (Direct Current Straight Polarity)

Detta är den vanligaste metoden (normal polaritet). Den orsakar ett begränsat slitage på elektroden (1) eftersom 70 % av värmen koncentreras på anoden (arbetsstycket).

Smältbadet blir smalt och djupt med hög frammatningshastighet och därmed låg värmeutveckling.

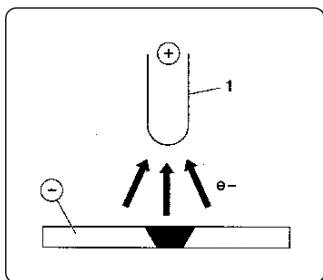

D.C.R.P. (Direct Current Reverse Polarity)

Med omvänd polaritet kan man svetsa legeringar täckta med ett eldfast oxidskikt med högre smälttemperatur än metallen.

Man kan inte använda hög strömstyrka eftersom detta skulle leda till högt slitage på elektroden.

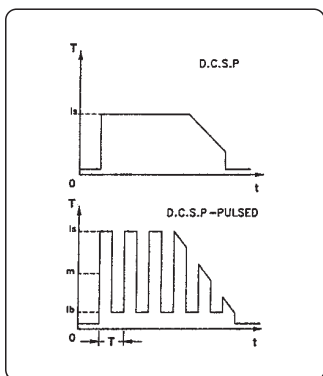

D.C.S.P.-Pulsed (Direct Current Straight Polarity Pulsed)

Genom att använda pulsad likström får man bättre kontroll av smältbadet under vissa driftsförhållanden.

Smältbadet bildas av toppströmmarna (I_p), medan basströmmen (I_b) håller igång bågen. På så sätt underlättas svetsning i material med liten tjocklek och resultatet blir färre deformationer, bättre formfaktor och följaktligen mindre risk för sprickor och gasinneslutningar.

Vid ökad frekvens (medelfrekvens) blir bågen smalare, mer koncentrerad och stabil och kvaliteten vid svetsning i tunna material förbättras ytterligare.

TIG-svetsningsegenskaper

TIG-metoden är mycket effektiv vid svetsning av både kolstål och legeringar, för den första svetssträngen på rör och för svetsningar där utmärkta estetiska egenskaper fordras.

Direkt polaritet (D.C.S.P.) används.

Förberedelse av kanterna

Denna metod fordrar en noggrann rengöring och förberedelse av kanterna.

Val och förberedelse av elektrod

Vi rekommenderar att toriumöverdragna volframelektroder (2 % torium - röd), alternativt elektroder belagda med cerium eller lantan, med följande diametrar används:

Strömstyrkeintervall			Elektrod	
(DC-)	(DC+)	(AC)	Ø	α
3-20 A	-	3-20 A	0,5 mm	30°
15-80 A	-	20-30 A	1,0 mm	30-60°
70-150 A	10-20 A	30-80 A	1,6 mm	60-90°
150-250 A	15-30 A	60-130 A	2,4 mm	90-120°
250-400 A	25-40 A	100-180 A	3,2 mm	120-150°
400-500 A	40-55 A	160-240 A	4,0 mm	150-180°
500-750 A	55-80 A	190-300 A	4,8 mm	150-180°
750-1100 A	80-125 A	325-450 A	6,4 mm	150-180°

Elektroden formas som i figuren.

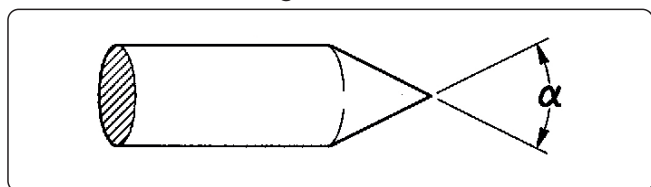

Svetsmaterial

Svetsstavarna ska ha liknande mekaniska egenskaper som basmaterialet.

Vi rekommenderar inte användning av remsor tagna från basmaterialet, eftersom de kan innehålla orenheter orsakade av bearbetningen som kan inverka negativt på svetsningen.

Skyddsgas

Ren argon (99,99 %) används praktiskt taget alltid.

Strömstyrkeintervall			Gas	
(DC-)	(DC+)	(AC)	Munstycke	Flöde
3-20 A	-	3-20 A	n° 4	5-6 l/min
15-80 A	-	20-30 A	n° 5	6-8 l/min
70-150 A	10-20 A	30-80 A	n° 6	7-10 l/min
150-250 A	15-30 A	60-130 A	n° 7	8-12 l/min
250-400 A	25-40 A	100-180 A	n° 8	10-14 l/min
400-500 A	40-55 A	160-240 A	n° 8	12-16 l/min
500-750 A	55-80 A	190-300 A	n° 10	15-20 l/min
750-1100 A	80-125 A	325-450 A	n° 12	20-25 l/min

10. TEKNISKA DATA

Elektriska egenskaper			U.M.
Nätspänning U1 (50/60 Hz)	3x230 (±15%)	3x400 (±15%)	Vac
Zmax (@PCC) *	53	53	mΩ
Trög linjesäkring	25	16	A
Kommunikationsbuss	DIGITAL	DIGITAL	
Maximal upptagen spänning	10.5	10.5	kVA
Maximal upptagen spänning	10.1	10.1	kW
Effektförbrukning vid avaktiverat tillstånd	51	51	W
Effektfaktor (PF)	0.96	0.96	
Effektivitet (μ)	83	83	%
Cos φ	0.99	0.99	
Maximal strömförbrukning I1max	30.8	15.3	A
Strömmens effektivvärde I1eff	18	9	A
Inställningsintervall	3-270	3-270	A
Tomgångsström Uo	80	80	Vdc
Toppspanning Up	10.1	10.1	kV







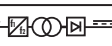

*Den här utrustningen uppfyller de krav som ställs i EN / IEC 61000-3-11.

*Denna utrustning uppfyller kraven enligt EN / IEC 61000-3-12 om maximalt tillåten nätimpedans vid den gemensamma anslutningspunkten (PCC) till det allmänna elnätet är mindre än eller lika med angivet värde på "Zmax". Om den ansluts till ett allmänt lågspänningssystem är det den som installerar eller använder utrustningen som ansvarar för att kontrollera att utrustningen får anslutas (genom att rådfråga elnätsleverantören vid behov).





Utnyttjningsfaktor	3x230V	3x400V	U.M.
Utnyttjningsfaktor (40°C)			
(X=35%)	270	270	A
(X=60%)	230	230	A
(X=100%)	180	180	A
Utnyttjningsfaktor (25°C)			
(X=80%)	270	270	A
(X=100%)	240	240	A

Fysiska egenskaper			U.M.
IP-skyddsgrad	IP23S		
Isoleringsklass	H		
Mått (lxbxh)	500x190x400		mm
Vikt	18.8		Kg
Strömkabelsektion	4x4		mm ²
Nätkabelns längd	5		m
Konstruktionsbestämmelser	EN IEC 60974-1/A1:2019 EN IEC 60974-3:2019 EN 60974-10/A1:2015		

11. MÄRKPLÅT

 VOESTALPINE BÖHLER WELDING SELCO S.R.L. Via Palladio, 19 - ONARA (PADOVA) - ITALY			
URANOS NX 2700 TLH		N°	
 EN 60974-1/A1:2019 IEC 60974-10/A1:2015 Class A		60974-3:2019	
 Up 10.1 kV 3A/10.0V - 270A (270A)/20.8V (20.8V)			
X (40°C)			
35% 60% 100%			
S	U ₀	I ₂	270A (270A) 230A (230A) 180A (180A)
	80V	U ₂	20.8V (20.8V) 19.2V (19.2V) 17.2V (17.2V)
 3A/20.0V - 270A (270A)/30.8V (30.8V)			
X (40°C)			
35% 60% 100%			
S	U ₀	I ₂	270A (270A) 230A (230A) 180A (180A)
	80V	U ₂	30.8V (30.8V) 29.2V (29.2V) 27.2V (27.2V)
 U ₁ 400V(230V)		I _{1max} 15.3A(30.8A)	I _{1eff} 9A(18A)
IP 23 S		  	
MADE IN ITALY 			

12. MÄRKPLÅTENS INNEBÖRD

1		2			
3		4			
5	6				
7	9	23			
		11			
8	10	12	15	16	17
		13	15A	16A	17A
		14	15B	16B	17B
7	9	11			
		12	15	16	17
8	10	13	15A	16A	17A
		14	15B	16B	17B
		18	19	20	21
22	  				
MADE IN ITALY 					

CE EU-försäkran om överensstämmelse
 EAC EAC-försäkran om överensstämmelse
 UKCA UKCA-försäkran om överensstämmelse

- 1 Fabrikat
- 2 Tillverkarens namn och adress
- 3 Apparatens modell
- 4 Serienummer
 XXXXXXXXXXXX Tillverkningsår
- 5 Symbol för svetsstyp
- 6 Hänvisning till tillverkningsstandarder
- 7 Symbol för svetsprocess
- 8 Symbol för svetsar som lämpar sig för arbete i utrymmen med förhöjd risk för elstötar
- 9 Symbol för svetsström
- 10 Nominell tomgångsspänning
- 11 Intervall för max. och min. nominell svetsström och motsvarande normal belastningsspänning
- 12 Symbol för intermittenncykel
- 13 Symbol för nominell svetsström
- 14 Symbol för nominell svetspänning
- 15 Värdet för intermittenncykel
- 16 Värdet för intermittenncykel
- 17 Värdet för intermittenncykel
- 15A Värdet för nominell svetsström
- 16A Värdet för nominell svetsström
- 17A Värdet för nominell svetsström
- 15B Värdet för normal belastningsspänning
- 16B Värdet för normal belastningsspänning
- 17B Värdet för normal belastningsspänning
- 18 Symbol för nätanslutning
- 19 Nominell matningsspänning
- 20 Max. nominell matningsström
- 21 Max. effektiv matningsström
- 22 Kapslingsklass
- 23 Nominell toppspänning

EU-OVERENSSTEMMELSESERKLÆRING

Byggeren

voestalpine Böhler Welding Selco S.r.l. - Via Palladio, 19 - 35019 Onara di Tombolo (PD) - ITALY
Tel. +39 049 9413/111 - Fax +39 049 9413/311 - www.voestalpine.com/welding

erklærer under eget ansvar, at det følgende produkt:

URANOS NX 2700 TLH

55.07.042

55.07.043

er i overensstemmelse med følgende EU-direktiver:

2014/35/EU LOW VOLTAGE DIRECTIVE

2014/30/EU EMC DIRECTIVE

2011/65/EU RoHS DIRECTIVE

2019/1784/EU EcoDesign

2009/125/EU EcoDesign

og at følgende harmoniserede standarder er anvendt:

EN IEC 60974-1/A1:2019

WELDING POWER SOURCE

EN IEC 60974-3:2019

ARC STRIKING AND STABILIZING DEVICES

EN 60974-10/A1:2015

ELECTROMAGNETIC COMPATIBILITY REQUIREMENTS

Dokumentationen, der bekræfter overholdelse af direktiverne, holdes tilgængelig til inspektion hos den førnævnte producent.

Ethvert indgreb eller enhver ændring, der ikke er autoriseret af voestalpine Böhler Welding Selco S.r.l., vil medføre, at denne erklæring ikke længere er gyldig.

Onara di Tombolo, 01/07/2024

voestalpine Böhler Welding Selco s.r.l.



Mirco Frasson

Ivo Bonello

Managing Directors

INDHOLDSFORTEGNELSE

1. ADVARSEL	296
1.1 Brugsomgivelser	296
1.2 Personlig beskyttelse og beskyttelse af andre	296
1.3 Beskyttelse mod røg og gas	297
1.4 Forebyggelse af brand/eksplosion	298
1.5 Forholdsregler ved brug af gasflasker	298
1.6 Beskyttelse mod elektrisk stød	298
1.7 Elektromagnetiske felter og forstyrrelser	298
1.8 IP-beskyttelsesgrad	299
1.9 Bortskaffelse	300
2. INSTALLERING	300
2.1 Løfte-, transport- og aflæsningsanvisninger	300
2.2 Placering af anlægget	300
2.3 Tilslutning	300
2.4 Idriftsættelse	301
3. PRÆSENTATION AF ANLÆGGET	302
3.1 Bagpanel	302
3.2 Stikkontaktpanel	302
3.3 Frontbetjeningspanel	303
4. UDSTYR BRUG	304
4.1 Startskærm	304
4.2 Hovedskærmen	304
4.3 Hovedbilledskærm MMA proces	304
5. SETUP	308
5.1 Set-up og indstilling af parametrene	308
5.2 Specifikke procedurer for brug af parametrene	315
6. VEDLIGEHOLDELSE	318
6.1 Regelmæssig kontrol af strømkilden	319
6.2 Vastuu	319
7. ALARMKODER	319
8. FEJLFINDING OG LØSNINGER	321
9. BETJENINGSVEJLEDNING	324
9.1 Svejsning med beklædt elektrode (MMA)	324
9.2 TIG-svejsning (kontinuerlig lysbue)	325
10. TEKNISKE SPECIFIKATIONER	327
11. DATASKILT	328
12. BETYDNING AF OPLYSNINGERNE DATASKILT	328
13. OVERSIGT	438
14. KONNEKTORER	440
15. RESERVEDELSLISTE	441

SYMBOLER



Advarsel



Forbud



Forpligtelser



Generelle indikationer

1. ADVARSEL



Inden der udføres nogen form for indgreb, skal man have læst og forstået denne vejledning.

Der må ikke udføres ændringer på maskinen eller vedligeholdelse, der ikke er beskrevet i vejledningen. Fabrikanten påtager sig intet ansvar for legemsbeskadeligelse eller beskadigelse af ting, opstået på grund af manglende læsning eller udførelse af indholdet i denne vejledning.

Opbevar altid brugsanvisningerne på apparatets brugssted. Overhold ikke blot brugsanvisningerne, men også de generelle forskrifter og de gældende lokale regler for forebyggelse af ulykker og miljøhensyn.

voestalpine Böhler Welding Selco S.r.l. forbeholder sig ret til at foretage ændringer når som helst uden forudgående varsel.

Rettighederne til oversættelse, genoptrykning og redigering, enten hel eller delvis, med ethvert middel (inklusive fotokopier, film og mikrofilm) tilhører voestalpine Böhler Welding Selco S.r.l. og er forbudt uden skriftlig tilladelse fra dette firma.

Disse anvisninger er af vital vigtighed og derfor nødvendige for garantiens opretholdelse.

Fabrikanten fralægger sig ethvert ansvar, hvis operatøren ikke overholder disse forskrifter.



Alle personer med ansvar for ibrugtagning, for brug, for vedligeholdelse og for reparation af apparatets skal

- besidde den relevante kvalifikation
- have de nødvendige kompetencer med hensyn til svejsning
- læse hele denne brugsvejledning og nøje følge anvisningerne.

Tag kontakt til en fagmand i tilfælde af tvivl eller problemer omkring anlæggets brug, også selvom problemet ikke omtales heri.

1.1 Brugsomgivelser



Ethvert anlæg må udelukkende benyttes til dets forudsete brug, på de måder og områder, der er anført på dataskiltet og/eller i denne vejledning, og i henhold til de nationale og internationale sikkerhedsforskrifter. Anden brug end den, fabrikanten udtrykkeligt har angivet, skal betragtes som u hensigtsmæssig og farlig og vil fritage fabrikanten for enhver form for ansvar for skade.



Dette apparat må udelukkende anvendes til professionelle formål i industrielle omgivelser. Fabrikanten fralægger sig ethvert ansvar for skader forårsaget af anlæggets brug i private omgivelser.



Anlægget skal anvendes i omgivelser med en temperatur på mellem -10°C og +40°C (mellem +14°F og +104°F).

Anlægget skal transporteres og opbevares i omgivelser med en temperatur på mellem -25°C og +55°C (mellem -13°F og 131°F).

Anlægget skal benyttes i omgivelser uden støv, syre, gas eller andre ætsende stoffer.

Anlægget skal benyttes i omgivelser med en relativ luftfugtighed på højst 50 % a 40°C (104°F).

Anlægget skal benyttes i omgivelser med en relativ luftfugtighed på højst 90 % ved 20°C (68°F).

Anlægget må ikke benyttes i en højde over havet på over 2000m (6500 fod).



Anvend ikke apparatet til optøning af rør.

Benyt aldrig dette apparatur til opladning af batterier og/eller akkumulatorer.

Benyt aldrig dette apparatur til start af motorer.

1.2 Personlig beskyttelse og beskyttelse af andre



Svejsprocessen er kilde til skadelig stråling, støj, varme og gasudsendelse. Anbring en brandsikker afskærmning for at beskytte omgivelserne svejsmiljø mod stråler, gnister og glødende affald. Advar andre tilstedeværende om, at de ikke må rette blikket direkte mod svejsningen, og at de skal beskytte sig imod buens stråler eller glødende metalstykker.



Bær beskyttelsestøj til beskyttelse af huden mod lysbuestrålerne, gnister eller glødende metal. Den benyttede beklædning skal dække hele kroppen og være:

- intakt og i god stand
- brandsikker
- isolerende og tør
- tætsiddende og uden opslag



Benyt altid godkendt og slidstærkt sikkerhedsfodtøj, der er i stand til at sikre isolering mod vand.



Benyt altid godkendte sikkerhedshandsker, der yder en elektrisk og termisk isolering.



Anvend masker med sideskærme for ansigtet og egnet beskyttelsesfilter (mindst NR10 eller højere) for øjnene.



Benyt altid beskyttelsesbriller med sideafskærmning, især ved manuel eller mekanisk fjernelse af svejse-affaldet.



Bær aldrig kontaktlinser!



Benyt høreværn, hvis svejseprocessen når op på farlige støjniveauer. Hvis støjniveauet overskrider de grænser, der er fastlagt i lovgivningen, skal man afgrænse arbejdsområdet og sørge for, at de personer der har adgang, er beskyttet med høreværn.



Hold altid sidepanelerne lukkede under svejsearbejdet. Der må aldrig udføres nogen form for ændringer på anlægget.



Undgå berøring af emner, der lige er blevet svejset. Varmen vil kunne forårsage alvorlige skoldninger eller forbrændinger.



Overhold alle ovenfor beskrevne forholdsregler, også under bearbejdnings efter svejsningen, da svejseaffald kan falde af de bearbejdede emner, der er ved at køle af.



Kontrollér, at brænderen er kølet af, inden der udføres bearbejdnings eller vedligeholdelse.



Kontrollér, at kølegruppen er slukket, inden kølevæskens tilførsels- og afledningslanger kobles fra. Den varme væske, der løber ud af rørene, vil kunne forårsage alvorlige skoldninger eller forbrændinger.



Sørg for, at der er førstehjælpsudstyr til rådighed.
Undervurder aldrig forbrændinger og sår.



Genopret sikre forhold i området, inden arbejdsområdet forlades, således at utilsigtet skade på personer og genstande undgås.

1.3 Beskyttelse mod røg og gas



Røg, gas og støv fra svejse-arbejdet kan medføre sundhedsfare.
Røgen, der produceres under svejseprocessen, kan under visse forhold forårsage cancer eller fosterskade.

- Hold hovedet på lang afstand af svejsningens gas og røg.
- Sørg for ordentlig naturlig eller mekanisk udluftning i arbejdsområdet.
- Benyt svejsemasker med udsugning, hvis lokalets ventilation er utilstrækkelig.
- Ved svejsning i snævre omgivelser anbefales det, at der er en kollega til stede udenfor området til overvågning af den medarbejder, der udfører selve svejsningen.
- Anvend aldrig ilt til udluftning.
- Undersøg udsugningens effektivitet ved, med jævne mellemrum, at sammenholde emissionsmængden af giftig gas med de tilladte værdier i sikkerhedsforskrifterne.
- Mængden og farligheden af den producerede røg kan tilbageføres til det anvendte basismateriale, til det tilførte materiale samt til eventuelt anvendte rengøringsmidler eller affedtningmidler på det emne, der skal svejses. Følg omhyggeligt fabrikantens anvisninger og de relevante tekniske datablade.
- Udfør aldrig svejsning i nærheden af områder, hvor der foretages affedtning eller maling.
- Placer gasflaskerne udendørs eller på steder med korrekt luftcirkulation.

1.4 Forebyggelse af brand/eksplosion



Svejs-processen kan være årsag til brand og/eller eksplosion.

- Fjern antændelige eller brændbare materialer eller genstande fra arbejdsområdet og det omkringliggende område.
- Brændbare materialer skal befinde sig mindst 11 meter fra svejseområdet og skal beskyttes på passende vis.
- Gnister og glødende partikler kan nemt blive spredt vidt omkring og nå de omkringliggende områder, også gennem små åbninger. Udvis særlig opmærksomhed omkring sikring af personer og genstande.
- Udfør aldrig svejsning oven over eller i nærheden af beholdere under tryk.
- Udfør aldrig svejsning på lukkede beholdere eller rør. Udfør aldrig svejsning eller skæring på lukkede beholdere eller rør. Udvis særlig opmærksomhed under svejsning af rør eller beholdere, også selv om de er åbne, tomme og omhyggeligt rengjorte. Rester af gas, brændstof, olie og lignende kan forårsage eksplosioner.
- Udfør aldrig svejs-arbejde i en atmosfære med eksplosionsfarlige pulvermaterialer, gasser eller dampe.
- Kontrollér efter afsluttet svejsning, at kredsløbet under spænding ikke utilsigtet kan komme i berøring med elementer, der er forbundet til jordforbindelseskredsløbet.
- Sørg for, at der er brandslukningsudstyr til rådighed i nærheden af arbejdsområdet.

1.5 Forholdsregler ved brug af gasflasker



Gasflasker med inaktiv gas indeholder gas under tryk og kan eksplodere hvis transport-, opbevarings- og brugsforholdene ikke sikres efter forskrifterne.

- Gasflaskerne skal fastspændes opretstående på en væg eller lignende med egnede midler, så de ikke kan vælte eller støde sammen.
- Skru beskyttelseshætten på ventilen under transport, klargøring, og hver gang svejsarbejdet er fuldført.
- Undgå at gasflaskerne udsættes for direkte solstråler, pludselige temperaturudsving, for høje eller for lave temperaturer. Udsæt aldrig gasflaskerne for meget lave eller høje temperaturer.
- Undgå omhyggeligt, at gasflaskerne kommer i berøring med åben ild, elektriske buer, brændere, elektrodeholdertænger eller med glødende partikler fra svejsningen.
- Hold gasflaskerne på lang afstand af svejsekredsløb og strømkredsløb i almindelighed.
- Hold hovedet på lang afstand af det punkt, hvorfra gassen strømmer ud, når der åbnes for gasflaskens ventil.
- Luk altid for gasflaskens ventil, når svejsningen er fuldført.
- Udfør aldrig svejsning på en gasflaske under tryk.
- Tilslut aldrig en trykløftsflaske direkte til maskinens trykregulator! Trykket kan overskride trykregulatorens kapacitet, således at der opstår fare for eksplosion!

1.6 Beskyttelse mod elektrisk stød



Et elektrisk stød kan være dødbringende.

- Undgå berøring af strømførende dele både inden i og uden på svejseægget, så længe anlægget er under forsyning (brændere, tænger, jordforbindelseskabler, elektroder, ledninger, valser og spoler er elektrisk forbundet til svejsekredsløbet).
- Sørg for, at anlæg og elektrisk isoleret ved hjælp af tørre plader og sokler med tilstrækkelig isolering mod mulig jordforbindelse.
- Kontrollér, at anlægget er forbundet korrekt til et stik og en strømkilde udstyret med en jordledning.
- Berør aldrig to svejsebrændere eller to elektrodeholdertænger samtidigt.
- Afbryd øjeblikkeligt svejs-arbejdet, hvis det føles, som om der modtages elektrisk stød.



Dette udstyr til lysbuetænding og -stabilisering er fremstillet til manuel eller mekanisk styret betjening.



Øges længden af skærebrænderkabler eller svejskabler med mere end 8 meter, vil det betyde øget risiko for elektrisk chok.

1.7 Elektromagnetiske felter og forstyrrelser



Passagen af strøm igennem anlæggets indvendige og udvendige kabler skaber et elektromagnetisk felt i umiddelbar nærhed af svejskablerne og af selve anlægget.

- Elektromagnetiske felter kan forårsage (på nuværende tidspunkt ukendte) helbredseffekter ved længerevarende påvirkning.
- De elektromagnetiske felter kan påvirke andet apparatur så som pacemakere eller høreapparater.



Bærere af vitale elektroniske apparater (pacemaker) bør konsultere en læge, inden de kommer i nærheden af lysbuesvejsninger.

1.7.1 Klassificering EMC i overensstemmelse med: EN 60974-10/A1:2015.

Klasse
B

Udstyr i klasse B overholder kravene vedrørende elektromagnetisk kompatibilitet i industrielle miljøer og private boliger, herunder boligområder, hvor elektriciteten leveres via det offentlige lavspændingsforsyningsnet.

Klasse
A

Udstyr i klasse A er ikke beregnet til brug i boligområder, hvor elektriciteten leveres via det offentlige lavspændingsforsyningsnet. Der kan være visse vanskeligheder med at sikre elektromagnetisk kompatibilitet for klasse A-udstyr i sådanne områder på grund af ledningsbårne forstyrrelser og strålingsforstyrrelser.

For mere information, se kapitlet: DATASKILT eller TEKNISKE SPECIFIKATIONER.

1.7.2 Installering, brug og vurdering af området

Dette apparat er bygget i overensstemmelse med kravene i den harmoniserede standard EN 60974-10/A1:2015 og er identificeret som et "KLASSE A"-apparat. Dette apparat må udelukkende anvendes til professionelle formål i industrielle omgivelser. Fabrikanten fralægger sig ethvert ansvar for skader forårsaget af anlæggets brug i private omgivelser.



Brugeren skal have ekspertise indenfor arbejdsområdet, og han/hun er i denne henseende ansvarlig for installering og brug af apparatet i overensstemmelse med fabrikantens anvisninger. Hvis der opstår elektromagnetiske forstyrrelser, er det brugerens opgave at løse problemet med hjælp fra fabrikantens tekniske servicetjeneste.



Elektromagnetiske forstyrrelser skal under alle omstændigheder reduceres i en sådan grad, at de ikke længere har nogen indflydelse.



Inden dette apparat installeres, skal brugeren vurdere de eventuelle elektromagnetiske problemer, der kan opstå i det omkringliggende område, specielt hvad angår de tilstedeværende personers sundhedstilstand, fx: brugere af pacemakere og høreapparater.

1.7.3 Krav til strømtilførsel (Se tekniske specifikationer)

Højspændingsudstyr kan på grund af primærstrømmen, som hentes fra forsyningsnettet, påvirke nettets strømkvalitet. For visse typer af udstyr (se tekniske specifikationer) kan der være restriktioner eller krav vedrørende strømtilslutningen med hensyn til strømforsyningsnets højeste tilladte impedans (Z_{max}) eller den påkrævede minimumskapacitet (S_{sc}) ved tilslutningsstedet til det offentlige elnet (point of common coupling, PCC). Hvis det er tilfældet, er det montørens eller brugerens ansvar at sikre, at udstyret kan tilsluttes; eventuelt ved henvendelse til elseskabet. Ved interferens kan der opstå behov for yderligere forholdsregler, så som filtrering af netforsyningen.

Desuden skal man overveje muligheden for afskærmning af forsyningskablet.

For mere information, se kapitlet: TEKNISKE SPECIFIKATIONER.

1.7.4 Forholdsregler vedrørende ledningerne

Følg nedenstående regler for at reducere virkningen af de elektromagnetiske felter:

- Rul, om muligt, jordforbindelses- og effektkablerne op og fastspænd dem.
- Undgå at vikke svejsekablet rundt om kroppen.
- Undgå at stå imellem jordforbindelseskablet og effektkablet (hold begge kabler på samme side).
- Kablerne skal holdes så korte som muligt, og de skal placeres så tæt sammen som muligt og føres nær eller på gulvplanet.
- Placer anlægget i en vis afstand af svejseområdet.
- Kablerne skal holdes adskilt fra alle øvrige kabler.

1.7.5 Potentialudligning

Der skal tages højde for stelforbindelse af alle metalkomponenter på svejse-anlægget og i den umiddelbare nærhed. Overhold den nationale lovgivning vedrørende potentialudligning.

1.7.6 Jordforbindelse af arbejdsemnet

Hvis arbejdsemnet ikke er jordforbundet af hensyn til den elektriske sikkerhed eller p.g.a. dets størrelse og placering, kan en stelforbindelse mellem emnet og jorden reducere udsendelserne. Vær opmærksom på, at jordforbindelsen af arbejdsemnet ikke må øge risikoen for arbejdsulykker for brugerne eller beskadige andre elektriske apparater. Overhold den nationale lovgivning vedrørende jordforbindelse.

1.7.7 Afskærmning

Afskærmning af udvalgte kabler og apparater i det omkringliggende område kan løse interferensproblemer.

Muligheden for afskærmning af hele svejse-anlægget kan overvejes i specielle arbejdssituationer.

1.8 IP-beskyttelsesgrad

IP

IP23S

- Indkapslingen er beskyttet mod indføring af fingre og faste fremmedlegemer med en diameter større end/lig med 12,5 mm og berøring af farlige dele.
- Indkapslingen er beskyttet mod regn i en vinkel på op til 60° fra lodret position.
- Indkapslingen er beskyttet mod skader forårsaget af vandindtrængning, når apparaturets bevægelige dele ikke er i bevægelse.

1.9 Bortskaffelse



Apparatet må ikke bortskaffes med normalt affald.

I overensstemmelse med det europæiske direktiv 2012/19/EU om affald af elektrisk og elektronisk udstyr og dets implementering i overensstemmelse med national lovgivning skal elektrisk udstyr, der er udtjent, indsamles separat og sendes til nyttiggørelse og bortskaffelse. Ejeren af udstyret skal identificere de autoriserede indsamlingscentre ved at forhøre sig hos kommunen. Anvendelsen af det europæiske direktiv vil forbedre miljøet og menneskers sundhed.

» Se hjemmesiden for yderligere oplysninger.

2. INSTALLERING



Installeringen må kun udføres af erfarent personale, der godkendt af svejsemaskinens fabrikant.



Ved installering skal man sørge for, at strømkilden er afbrudt fra forsyningsnettet.



Der er forbudt at forbinde strømkilderne (i serie eller parallelt).

2.1 Løfte-, transport- og aflæsningsanvisninger

• Anlægget er udstyret med et greb, der giver mulighed for at transportere det i hånden.



Undervurder aldrig anlæggets vægt, (læs de tekniske specifikationer).

Lad aldrig læsset glide hen over - eller hænge stille over - mennesker eller ting.

Lad aldrig anlægget eller de enkelte enheder falde eller støtte mod jordoverfladen med stor kraft.

2.2 Placering af anlægget



Overhold nedenstående forholdsregler:

- Der skal være nem adgang til betjeningsorganerne og tilslutningspunkterne.
- Placér aldrig udstyret i snævre områder.
- Anbring aldrig anlægget på en overflade med en hældning på over 10° i forhold til det vandrette plan.
- Slut anlægget til i et tørt, rent område med god udluftning.
- Beskyt anlægget mod direkte regn og solstråler.

2.3 Tilslutning



Anlægget er udstyret med et forsyningskabel til tilslutning til ledningsnettet.

Anlægget kan forsynes med:

- 230V trefase
- 400V trefase

Apparatets funktion er garanteret ved spændinger, der afviger op til $\pm 15\%$ fra den nominelle værdi.



For at undgå personskader eller beskadigelse af anlægget skal man kontrollere den valgte netspænding og sikringerne, **INDEN** maskinen tilsluttes nettet. Desuden skal man sikre, at kablet tilsluttes en stikkontakt, der er udstyret med jordkontakt.



Det er muligt at forsyne anlægget via et generator-aggregat, hvis dette blot sikrer en stabil forsyningspænding på $\pm 15\%$ af værdien af den mærkespænding, som fabrikanten har oplyst, under alle mulige driftsforhold og ved den maksimale mærkeeffekt, som strømkilden kan levere. Det anbefales, som en norm, at benytte generator-aggregater med en effekt svarende til det dobbelte af strømkildens effekt, hvis den er enfaset, og svarende til 1,5 gang så stor, hvis den er trefaset. Det anbefales at benytte elektronisk styrede generator-aggregater.



Af hensyn til brugernes sikkerhed skal anlægget være korrekt jordforbundet. Forsyningskablet er udstyret med en (gul-grøn) leder til jordforbindelse, der skal tilsluttes en stikkontakt med jordkontakt. Denne gul/grønne ledning må **ALDRIG** benyttes sammen med andre ledninger til spændingsudtag. Kontrollér, at der findes en "jordforbindelse" på det anvendte anlæg, samt at stikkontakten er i korrekt stand. Montér udelukkende typegodkendte stik i overensstemmelse med sikkerhedsreglerne.



De elektriske forbindelser skal være udført af teknikere, der opfylder de specifikke faglige og tekniske krav, samt være i overensstemmelse med den nationale lovgivning i det land, hvor installeringen finder sted.

2.4 Idriftsættelse

2.4.1 Tilslutning til MMA-svejsning



Tilslutningen vist på tegningen giver svejsning med omvendt polaritet. Hvis man ønsker svejsning med direkte polaritet, skal tilslutningen byttes om.

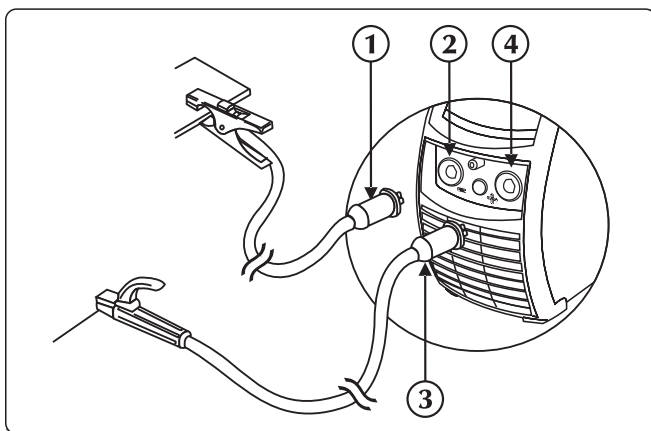



- ① Stik til jordforbindelsestang
- ② Negativt effektudtag (-)
- ③ Stik til elektrodeholdertang
- ④ Positivt effektudtag (+)

- ▶ Tilslut jordklemmen til den negative pol (-) på strømforsyningen. Sæt stikket i og drej med uret, indtil elementerne er skruet fuldstændigt fast.
- ▶ Tilslut elektrodeholderen til den positive pol (+) på strømforsyningen. Sæt stikket i og drej med uret, indtil elementerne er skruet fuldstændigt fast.

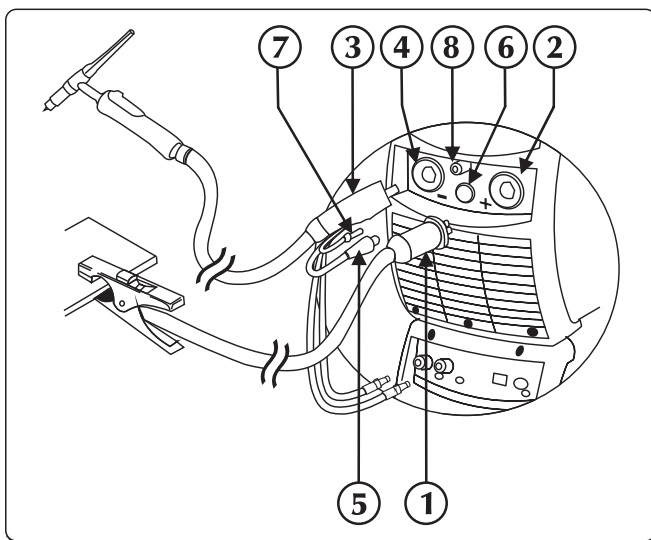
2.4.2 Tilslutning til TIG-svejsning



- ① Stik til jordforbindelsestang
- ② Positivt effektudtag (+)
- ③ Fastgørelse af TIG-fakkel
- ④ Brændertilslutning
- ⑤ Brænderens signalkabel
- ⑥ Konnektor
- ⑦ Fakkel gasrør
- ⑧ Samlestykke/kobling gas

- ▶ Tilslut jordklemmen til den positive pol (+) på strømforsyningen. Sæt stikket i og drej med uret, indtil elementerne er skruet fuldstændigt fast.
- ▶ Tilslut TIG-svejsbrænderstikket til svejsestikket på strømforsyningen. Sæt stikket i og drej med uret, indtil elementerne er skruet fuldstændigt fast.
- ▶ Tilslut brænderens signalkabel til det specielle stik.
- ▶ Tilslut brænderens gasrør til det specielle samlestykke/kobling.
- ▶ Forbind brænderens kølevæsketilbageledningsslange (rød farve) med det relevante samlestykke/kobling (rød farve - symbol ).
- ▶ Forbind brænderens kølevæsketilførselsslange (blå farve) med det relevante samlestykke/kobling (blå farve - symbol .

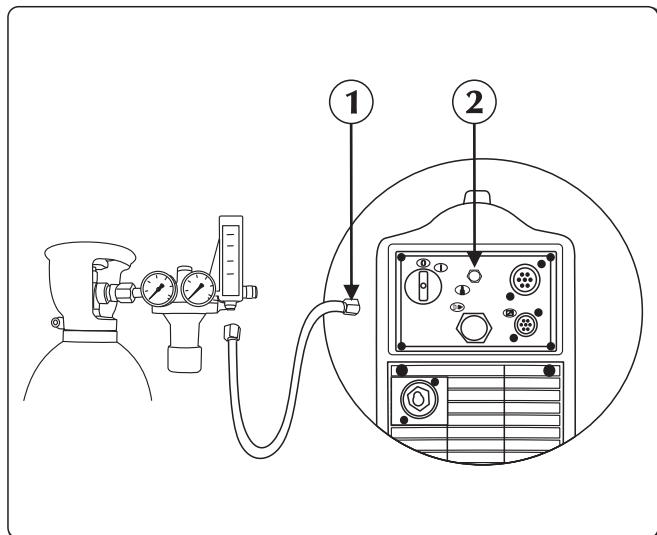

- ① Gasrør
- ② Samlestykke/kobling gas

► Tilslut gasslangen fra flasken til gassamlingen bagpå. Indstil gasstrømningen på mellem 5 og 15 l/min.

3. PRÆSENTATION AF ANLÆGGET

3.1 Bagpanel

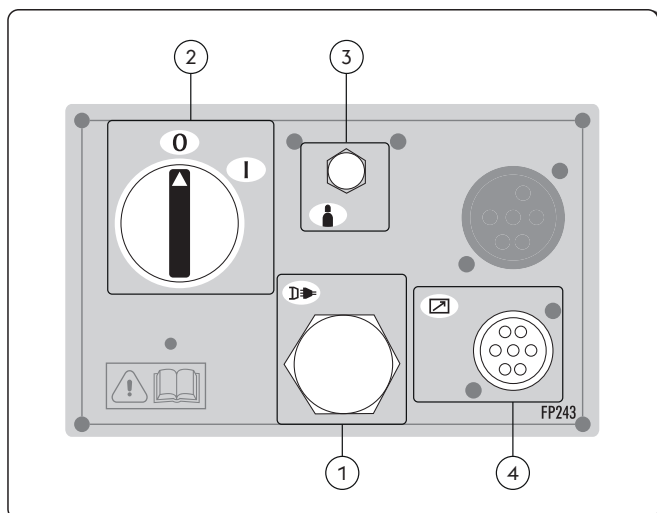

- ① Forsyningskabel
Kablet giver mulighed for at forsyne anlægget og koble det til ledningsnettet.
- ② Tændingskontakt
Knap til at tænde for strømmen til anlægget
Den kan stilles i to positioner: "0" slukket; "I" tændt.
- ③ Gastilslutning
- ④ Signalkabel CAN-BUS input (RC, RI...)

3.2 Stikkontaktpanel

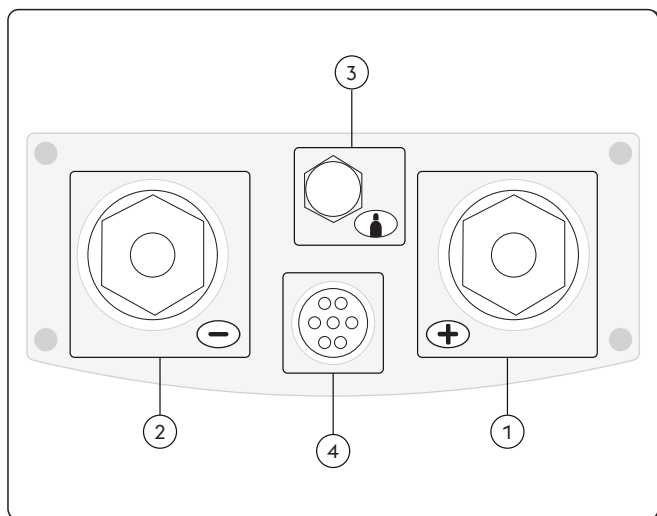







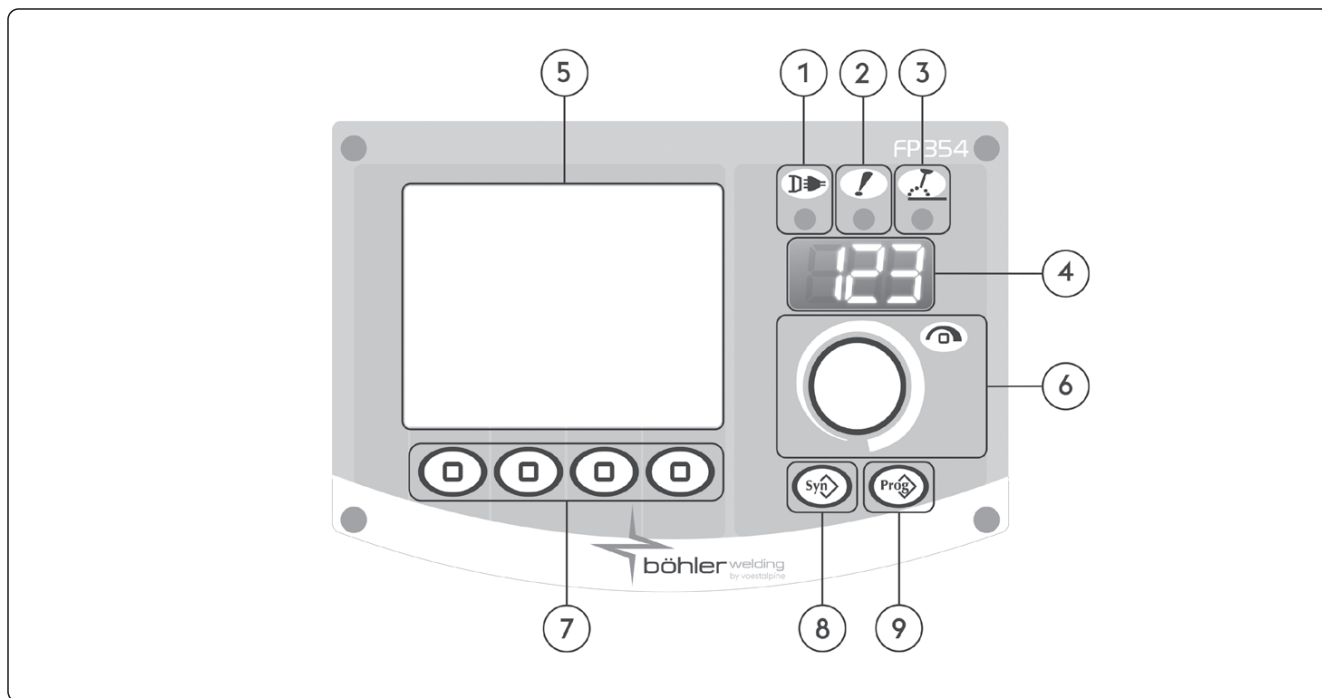

- ① Positivt effektudtag (+)
Proces MMA: Tilslutning elektrodebrænder
Proces TIG: Tilslutning jordkabel
- ② Negativt effektudtag (-)
Proces MMA: Tilslutning jordkabel
Proces TIG: Tilslutning af brænder
- ③ Gastilslutning
- ④ Indgang signalkabel (TIG-brænder)





DA

3.3 Frontbetjeningspanel

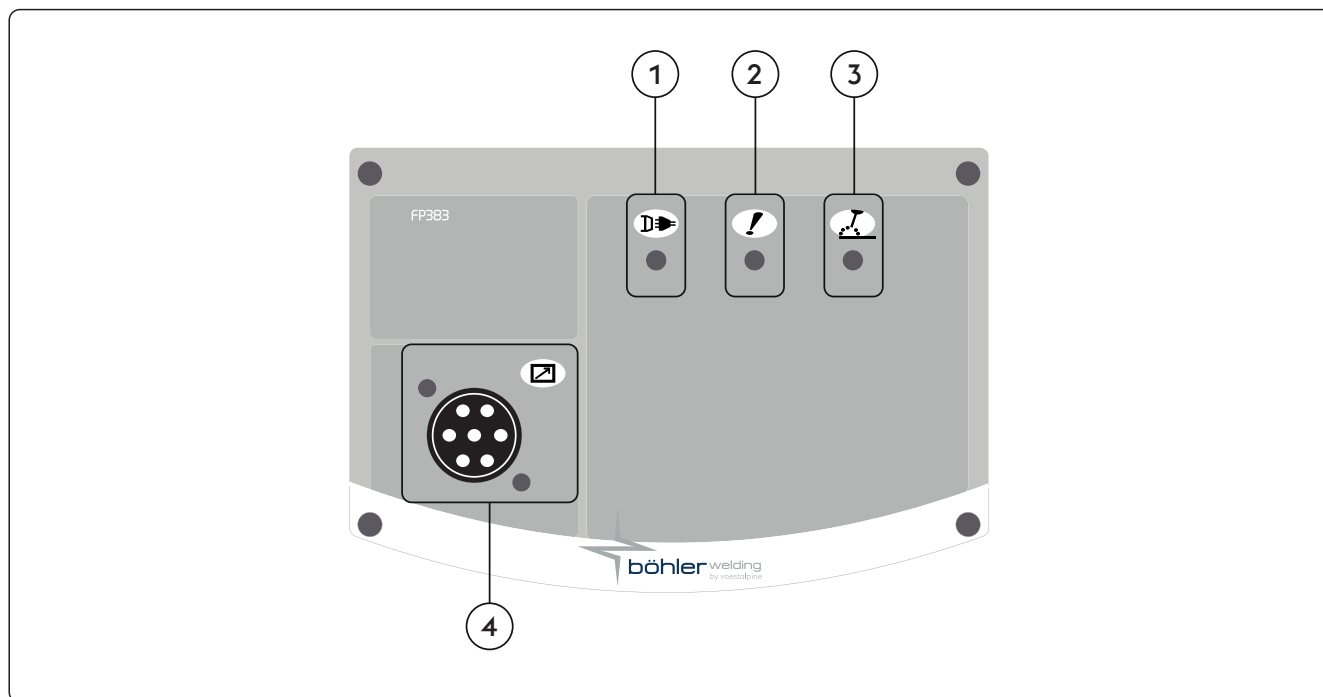

- 1  **LED for strømforsyning**
 Angiver, at anlægget er tilsluttet forsyningsnettet og tændt.
- 2  **LED for generel alarm**
 Angiver, at beskyttelsesanordninger, som f.eks. temperaturbeskyttelsen, kan aktiveres.
- 3  **LED for aktiv effekt**
 Angiver, at der er spænding på anlæggets udgangsforbindelser.
- 4  **7-segment display**
 Gør det muligt at vise svejsemaskinens generelle parametre under opstart, indstillinger, strøm- og spændingsaflysninger, under svejsning og indkodning af alarmer.
- 5  **LCD-display**
 Gør det muligt at vise svejsemaskinens generelle parametre under opstart, indstillinger, strøm- og spændingsaflysninger, under svejsning og indkodning af alarmer.
 Alle aktiviteter kan vises samtidig.
- 6  **Reguleringshåndtag**
 Gør det muligt at regulere svejse-strømmen kontinuerligt.
 Giver mulighed for indtastning af valg og indstilling af svejseparametrene.
- 7  **Funktionsknapper**
 Gør det muligt at vælge systemets forskellige funktioner:
 - Svejsproces
 - Svejsemetoder
 - Strømpulsering
 - Grafik-funktion
- 8  **Ikke anvendt knap**
- 9  **Tasten job**
 Giver mulighed for at lagre og styre 240 job, som kan operatøren selv kan skræddersy.



- 1  **LED for strømforsyning**
Angiver, at anlægget er tilsluttet forsyningsnettet og tændt.
- 2  **LED for generel alarm**
Angiver, at beskyttelsesanordninger, som f.eks. temperaturbeskyttelsen, kan aktiveres.
- 3  **LED for aktiv effekt**
Angiver, at der er spænding på anlæggets udgangsforbindelser.
- 4  **Signalkabel CAN-BUS input (RC, RI...)**

4. UDSTYR BRUG

4.1 Startskærm

Når anlægget tændes, udfører det en række kontroller, der har til formål at garantere dets korrekte funktion samt den korrekte funktion af alle de enheder, der er tilsluttet det. Samtidig udføres gastesten for at checke, om forbindelsen til gastilførselssystemet er i orden.

4.2 Hovedskærmen

Giver mulighed for at styre systemet og svejseprocessen, da den viser de væsentligste indstillinger.

4.3 Hovedbilledskærm MMA proces

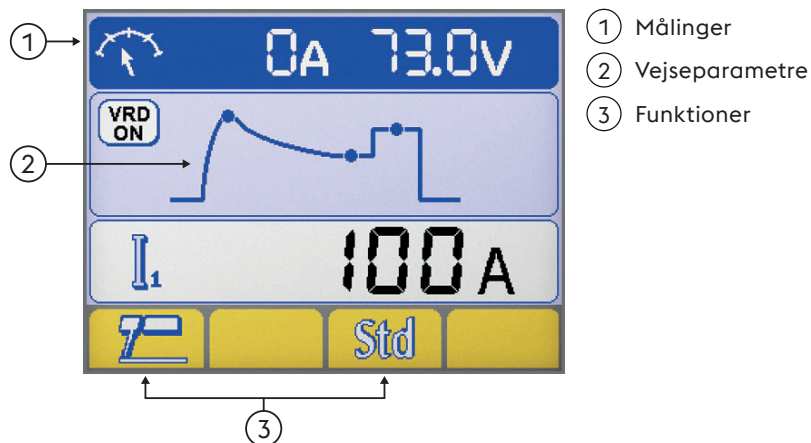

Målinger

I svejsefaserne vises de reelle strøm- og spændingsmål på LCD displayet.

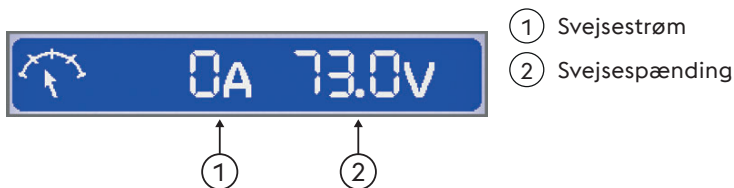

Vejseparametre

► Vælg de ønskede parametre ved at trykke på encoderknappen.

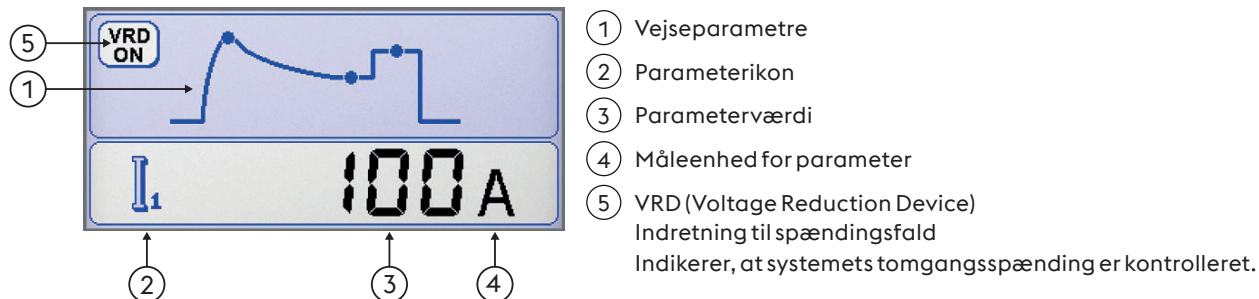

Funktioner

Gør det muligt at indstille de vigtigste procesfunktioner og svejsemetoder.

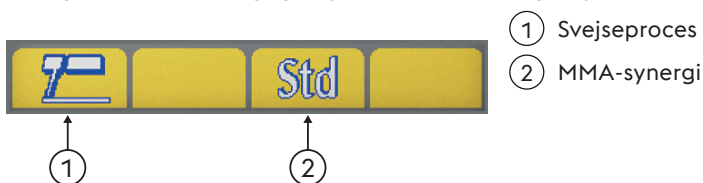

Svejseproces



MMA



TIG DC



MMA-synergi

Giver mulighed for at indstille buens dynamik bedst muligt ved at markere den anvendte elektrode type.

En korrekt valgt lysbue-dynamik gør det muligt at udnytte anlæggets ydeevne optimalt for at opnå de bedst mulige ydelser ved svejsningen.



Standard
(Basisk/Rutil)



Cellulose



Stål



Aluminium



Støbejern



Der garanteres ikke perfekt svejsbarhed af den anvendte elektrode.

Svejsbarhed, der afhænger af de nedsmeltende elektroders kvalitet, deres opbevaring, af de operative funktionsmåder og af svejseforholdene, af de utallige mulige anvendelser...

DA

4.4 Hovedskærm-billede TIG proces

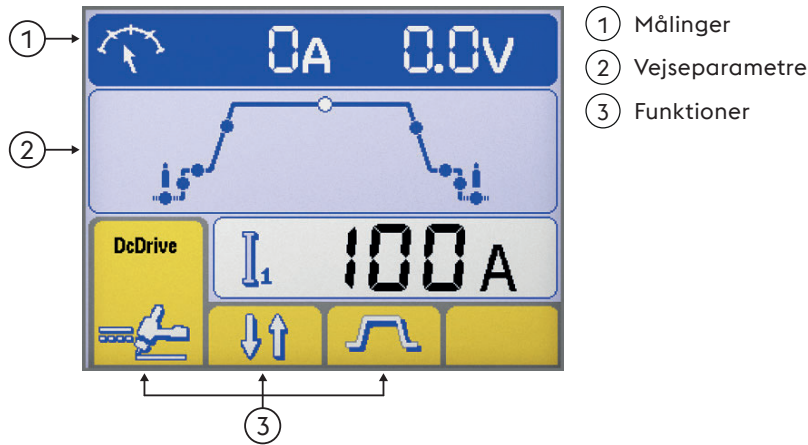

Målinger

I svejsefaserne vises de reelle strøm- og spændingsmål på LCD displayet.

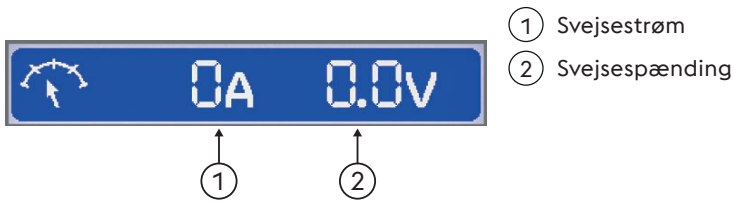

Vejseparametre

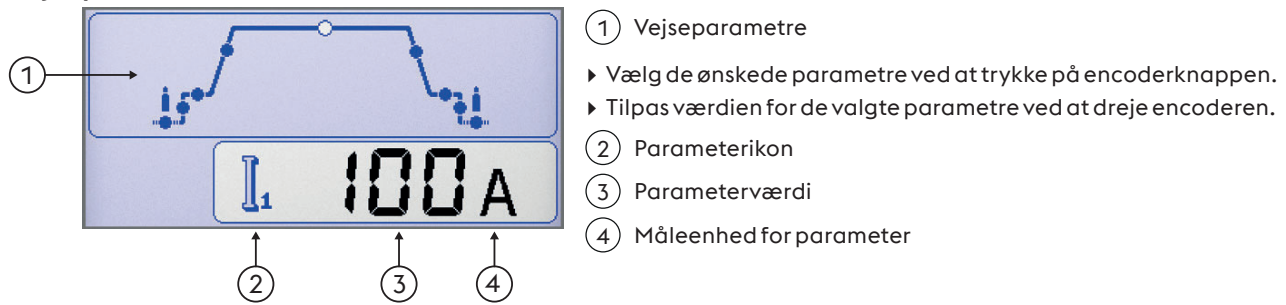

Funktioner

Gør det muligt at indstille de vigtigste procesfunktioner og svejsemetoder.

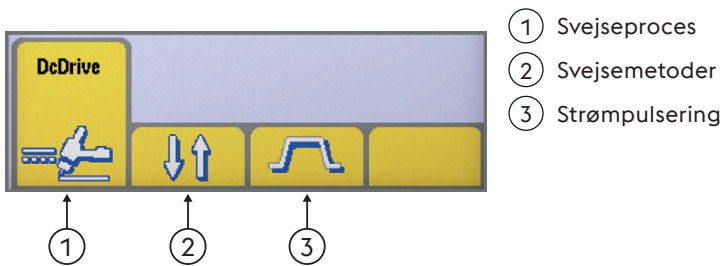

Svejseproces

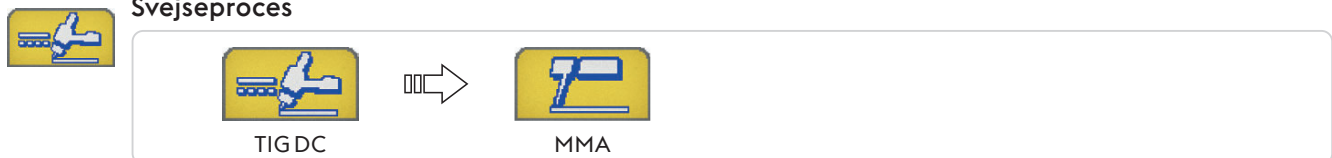

DA



Svejsemetoder

Her kan vælges svejsemetode



2 taktr

I 2 taktr: et tryk på knappen får gassen til at strømme og ramme lysbuen. Når knappen slippes, vender strømmen tilbage til nul i slope-down-tiden. Når lysbuen er slukket, strømmer gassen i gasefterstrømningstiden.



4 taktr

I 4 taktr: det første tryk på knappen får gassen til at strømme, så der sker en manuel gasforstrømning. Når knappen slippes, tændes lysbuen.



Bilevel

I bilevel kan svejseapparatet svejse med to forskellige tidligere indstillede strømme. Ved det første tryk på knappen startes gasforstrømningstiden, lysbuen tændes, og der kan svejses med den første strøm. Når knappen slippes første gang, startes strømmens slope-up "I1". Hvis svejseren trykker på og slipper knappen hurtigt, skiftes der til "I2". Hvis han igen trykker på og slipper knappen hurtigt, vender systemet tilbage til "I1", osv. Hvis man trykker i længere tid på knappen, påbegyndes strømmens falderampe som resulterer i slutstrømmen. Når knappen slippes, slukkes lysbuen, mens gassen fortsætter med at strømme i gasefterstrømningstiden.



Strømpulsering



Konstant strøm



Impuls-strøm



Fast Pulse



EasyArc

4.5 Programskærm





Giver mulighed for at lagre og styre 240 job, som kan operatøren selv kan skræddersy.

Programmer (JOB)

Se sektionen "Hovedmenu"

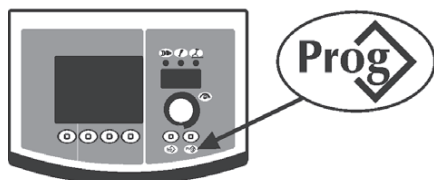
Programlagring



- ▶ Gå ind på skærbilledet "gem program" ved at trykke på knappen  i mindst et sekund.



- ▶ Vælg det ønskede program (eller en tom hukommelse) ved at dreje encodere.



--- Tom hukommelse

Gemt program

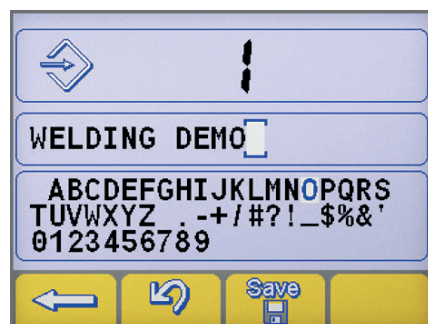
- ▶ Godkend ved at trykke på knappen .
- ▶ Gem alle eksisterende indstillinger i det valgte program ved at trykke på knappen .



Tilføj en beskrivelse af programmet.

- ▶ Vælg det ønskede bogstav ved at dreje encodere.
- ▶ Bogstavet lagres ved et tryk på encodere.
- ▶ Slet det sidste bogstav ved at trykke på knappen .
- ▶ Godkend ved at trykke på knappen .
- ▶ Godkend ved at trykke på knappen .



Lagringen af et nyt program i en allerede optaget hukommelse medfører sletning af hukommelsen via en obligatorisk procedure.



- ▶ Godkend ved at trykke på knappen
- ▶ Fjern det valgte program ved at trykke på knappen
- ▶ Genoptag lagringsproceduren.

Hent program

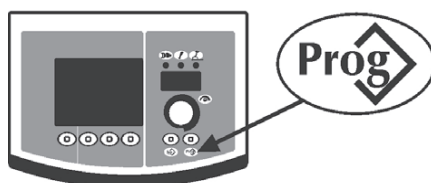

- ▶ Kald det 1 disponible program frem igen ved at trykke på knappen
 - ▶ Vælg det ønskede program ved at dreje encoderen.
 - ▶ Vælg det ønskede program ved at trykke på knappen
- Det er kun hukommelserne, der ligger i et program, der kaldes frem, mens de tomme springes automatisk over.

Slet program



- ▶ Vælg det ønskede program ved at dreje encoderen.
- ▶ Fjern det valgte program ved at trykke på knappen
- ▶ Godkend ved at trykke på knappen



- ▶ Godkend ved at trykke på knappen
- ▶ Fjern det valgte program ved at trykke på knappen

5. SETUP

5.1 Set-up og indstilling af parametrene

Giver mulighed for indstilling og regulering af en række ekstra parametre til en bedre og mere præcis administration af svejseanlægget.

Parametrene i setup er ordnet i henhold til den valgte svejseproces og har et kodenummer.

Adgang til setup





- ▶ Sker ved at trykke 5 sekunder på encoder-tasten.
- ▶ Indgangen bekræftes af angivelsen 0 på displayet.

Markering og indstilling af det ønskede parameter

- ▶ Opnås ved at dreje på indkodningstasten, indtil det ønskede parameters kodenummer vises.
- ▶ På dette tidspunkt giver et tryk på indkodningstasten mulighed for at få vist og regulere indstillingsværdien for det markerede parameter.

Udgang fra setup

- ▶ Tryk igen på indkodningstasten for at forlade "reguleringssektionen".
- ▶ Man forlader setup ved at gå til parameteret "0" (lagr og luk) og trykke på indkodningstasten.
- ▶ Godkend ved at trykke på knappen .
- ▶ Modifikationen gemmes og man forlader set up ved at trykke på tasten: .

5.1.1 Liste over parametrene i setup (MMA)

0 Lagr og luk



Giver mulighed for at lagre modifikationer og forlade setup.

1 Reset



Giver mulighed for at indstille alle parametrene på defaultværdierne igen.

3 Hot start



Giver mulighed for at regulere hot-start-værdien i MMA.

Herved tillades en mere eller mindre "varm" start under buens tændingsfaser, hvilket reelt letter starthandlingerne.

Basisk elektrode

Minimum	Maksimum	Default
0/off	500%	80%

Cellulose elektrode

Minimum	Maksimum	Default
0/off	500%	150%

CrNi-elektrode

Minimum	Maksimum	Default
0/off	500%	100%

Aluminium elektrode

Minimum	Maksimum	Default
0/off	500%	120%

Støbejerns elektrode

Minimum	Maksimum	Default
0/off	500%	100%

Rutil elektrode

Minimum	Maksimum	Default
0/off	500%	80%

7 Svejsestrøm

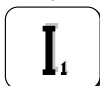

Giver mulighed for at regulere svejsestrømmen.

Minimum	Maksimum	Default
3 A	I _{max}	100 A

8 Arc force



Giver mulighed for at indstille værdien på Arc force i MMA.

Herved tillades en mere eller mindre energisk dynamisk respons under svejsning, hvilket reelt letter svejsehandlingerne.

Lysbuens styrkeværdi øges for at mindske risikoen for, at elektroden sidder fast.

Basisk elektrode

Minimum	Maksimum	Default
0/off	500%	30%

Cellulose elektrode

Minimum	Maksimum	Default
0/off	500%	350%

CrNi-elektrode

Minimum	Maksimum	Default
0/off	500%	30%

Aluminium elektrode

Minimum	Maksimum	Default
0/off	500%	100%

Støbejerns elektrode

Minimum	Maksimum	Default
0/off	500%	70%

Rutil elektrode

Minimum	Maksimum	Default
0/off	500%	80%

204 Dynamic power control (DPC)



Gør det muligt at vælge det ønskede forhold mellem spænding og strøm.

I=C Konstant strøm

Forøgelse eller mindskelse af lysbuehøjden har ingen indvirkning på den krævede svejsestrøm.

Anbefales til elektrode: Basisk, Rutil, Sur, Stål, Støbejern

1÷20 Karakteristik cadente con regolazione di rampa

Forøgelse af lysbuehøjden som følge af reduktion i svejsestrømmen (og vice versa) i henhold til den fastsatte værdi ved 1 til 20 ampere pr. volt.

Anbefales til elektrode: Cellulose, Aluminium

P=C Konstant spænding

Forøgelse af lysbuehøjden som følge af reduktion i svejsestrømmen (og vice versa) i henhold til formlen: $V \cdot I = K$

Anbefales til elektrode: Cellulose, Aluminium

312 Buens afbrydningspænding



Giver mulighed for at indstille den spændingsværdi, hvor den elektriske bue forceres til at slukke.

Det giver mulighed for bedre at administrere de forskellige driftsforhold, der opstår.

I punktvejsningsfasen, for eksempel, vil buens lavere afbrydningspænding give mulighed for en mindre lue, når elektroden flyttes væk fra emnet, hvilket reducerer sprutten, brænding og oxidering af emnet.



Indstil aldrig buens afbrydningspænding højere end strømkildens tomgangsspænding.

Basisk elektrode

Minimum	Maksimum	Default
0/off	Vmax	57.0 V

Cellulose elektrode

Minimum	Maksimum	Default
0/off	Vmax	70.0 V

399 Forskydningshastighed



Gør det muligt at indstille svejsningens udførelses hastighed.

Default cm/min: referencehastighed for håndsvæjsning.

Syn: Sinergic værdi.

Minimum	Maksimum	Default
2 cm/min	200 cm/min	15 cm/min

500 Indstilling af maskine



Gør det muligt at vælge den ønskede grafiske interface.

Gør det muligt at få adgang til højere set up-niveauer.

Se under "Skræddersyet interface (Set up 500)"

Værdi	Markeret niveau
USER	Bruger
SERV	Service
vaBW	vaBW

Værdi	Brugerinterface
XE	Tilstanden Easy
XA	Tilstanden Advanced
XP	Tilstanden Professional

551 Lock/unlock



Gør det muligt at låse kontrolpanelets indstillinger og at installere en beskyttelseskode.

Se under "Lock/unlock (Set up 551)".

552 Summetone



Giver mulighed for at justere summetonen.

Minimum	Maksimum	Default
0/off	10	10

601 Reguleringstrin



Gør det muligt at regulere et parameter med trin, som man selv kan skræddersy

Minimum	Maksimum	Default
1	I _{max}	1

602 Ekstern parameter 2



Gør det muligt at styre den eksterne parameter 2 (minimumværdi, maksimumværdi, defaultværdi, valgte parameter).

705 Justering af kredsløbsmodstand

Tillader at kalibrere anlægget.
 Se under "Justering af kredsløbsmodstand (set up 705)".

751 Strømaflæsning

Gør det muligt at se den faktiske værdi for svejsestrømmen.

752 Spændingsaflysning

Gør det muligt at aflæse den faktiske værdi for svejse-spænding.

768 Måling af tilført termisk energi HI

Tillader aflæsning af værdien på den tilførte termiske energi i svejsningen.

5.1.2 Liste over opsætningsparametre (TIG)
0 Lagr og luk

Giver mulighed for at lagre modifikationerne og forlade setup.

1 Reset

Giver mulighed for at indstille alle parametrene på defaultværdierne igen.

2 Præ-gas

Giver mulighed for at indstille og regulere gassens strømning, inden buen tændes.
 Giver mulighed for at fylde gas på brænderen og forberede omgivelserne til svejsningen.

Minimum	Maksimum	Default
0/off	99.9 s	0.1 s

3 Strøm ved tænding

Muliggør regulering af strømmen ved svejsningens start.
 Tillader at opnå et mere eller mindre varmt svejsebad i faserne, der følger umiddelbart efter tændingen.

Minimum	Maksimum	Default	Minimum	Maksimum	Default
1%	200%	50%	3 A	I _{max}	-

5 Strømtid ved tænding

Gør det muligt at indstille tiden, hvor startstrømmen bevares.

Minimum	Maksimum	Default
0/off	99.9 s	0/off

6 Stigningsrampe ("slope-up")

Giver mulighed for at indstille en blød overgang mellem strømmen ved tænding og under svejsning.

Minimum	Maksimum	Default
0/off	99.9 s	0/off

7 Svejsestrøm

Giver mulighed for at regulere svejsestrømmen.

Minimum	Maksimum	Default
3 A	I _{max}	100 A

8 Toplansstrøm



Giver mulighed for at regulere den sekundære strøm i tilstanden toplanssvejsning.
 Giver mulighed for at regulere den sekundære strøm i tilstanden toplanssvejsning.
 Når knappen slippes første gang, påbegyndes forøgelsesrampen som bringer strømmen op på niveauet "I1".
 Hvis man trykker og slipper trykknappen i hurtig rækkefølge, skifter man til "I2".
 Hvis man igen trykker og slipper trykknappen i hurtig rækkefølge, skifter man igen til "I1" og så videre.
 Hvis man trykker i længere tid på knappen, påbegyndes strømmens falderampe som resulterer i slutstrømmen.
 Når knappen slippes vil lysbuen gå ud hvorimod gassen fortsætter med at strømme indtil den er opbrugt.

Minimum	Maksimum	Default
3 A	I _{max}	-

Minimum	Maksimum	Default
1%	500%	off

10 Basisstrøm



Giver mulighed for at regulere basisstrømmen i impulstilstand og hurtig impulstilstand.

Minimum	Maksimum	Default
3 A	I _{sald}	-

Minimum	Maksimum	Default
1%	100%	50%

12 Impulsfrekvens



Tillader regulering af pulseringsfrekvensen.
 Gør det muligt at opnå de bedste svejseresultater for tynde tykkelser og det pæneste udseende af svejsesømmen.

Minimum	Maksimum	Default
0.1 Hz	25 Hz	5 Hz

13 Impulsmoduleret arbejdscyklus



Gør det muligt af indstille driftsperioden for pulsering.
 Tillader at bevare spidsstrømmen i kortere eller længere tid.

Minimum	Maksimum	Default
1 %	99 %	50 %

14 Fast Pulse Frekvens



Tillader regulering af pulseringsfrekvensen.
 Gør det muligt at opnå en større koncentration og en bedre stabilitet af lysbuen.

Minimum	Maksimum	Default
0.02 KHz	2.5 KHz	0.25 KHz

15 Impulsmoduleret stigning/sænkning



Tillader indstillingen af en rampetid i pulseringsfasen.
 Gør det muligt at opnå en gradvis overgang mellem spidsstrøm og basisstrøm, hvilket faktisk gør en bue mere eller mindre "blød".

Minimum	Maksimum	Default
0/off	100 %	0/off

16 Sænkingsrampe (slope-down)



Giver mulighed for at indstille en blød overgang mellem strømmen ved slukning og under svejsning.

Minimum	Maksimum	Default
0/off	99.9 s	0/off

17 Slutstrøm



Giver mulighed for at regulere slutstrømmen.

Minimum	Maksimum	Default
3 A	I _{max}	10 A

Minimum	Maksimum	Default
1 %	200 %	50 %

19 Endelig strømtid



Gør det muligt at indstille tiden, hvor slutstrømmen bevares.

Minimum	Maksimum	Default
0/off	99.9 s	0/off

20 Post-gas



Giver mulighed for at regulere gassens strømning ved svejsningens afslutning.

Minimum	Maksimum	Default
0/off	99.9 s	syn

203 Tig start (HF)

Tillader valg af den ønskede tændingsfunktion.

Værdi	Default	Tilbagekaldsfunktion
on	X	HF START
off	-	LIFT START

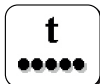
204 Punktsvejsning

Giver mulighed for at aktivere processen "punktsvejsning" og for at fastlægge svejsningens varighed. Tillader timing af svejseprocessen.

Minimum	Maksimum	Default
0/off	99.9 s	0/off

205 Restart

Tillader aktivering af funktionen restart.

Tillader øjeblikkelig slukning af buen i løbet af den nedadgående rampe eller ved genstart af svejsecyklen.

Værdi	Default	Tilbagekaldsfunktion
0/off	-	off
1/on	X	on
2/of1	-	off

206 Easy joining

Tillader tænding af buen i pulseret strøm og timing af funktionen før automatisk nulstilling af de forindstillede svejsebetingelser.

Tillader større hurtighed og præcision ved punktsvejsning af stykkerne.

Minimum	Maksimum	Default
0.1 s	25.0 s	0/off

208 Microtime spot welding

Giver mulighed for at aktivere processen "microtime spot welding".

Tillader timing af svejseprocessen.

Minimum	Maksimum	Default
0.01 s	1.00 s	0/off

399 Forskydningshastighed

Gør det muligt at indstille svejsningens udførelses hastighed.

Default cm/min: referencehastighed for håndsvejsning.

Syn: Sinergic værdi.

Minimum	Maksimum	Default
2 cm/min	200 cm/min	10 cm/min

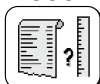
500 Indstilling af maskine

Gør det muligt at vælge den ønskede grafiske interface.

Gør det muligt at få adgang til højere set up-niveauer.

Se under "Skræddersyet interface (Set up 500)"

Værdi	Markeret niveau	Værdi	Brugerinterface
USER	Bruger	XE	Tilstanden Easy
SERV	Service	XA	Tilstanden Advanced
vaBW	vaBW	XP	Tilstanden Professional

551 Lock/unlock

Gør det muligt at låse kontrolpanelets indstillinger og at installere en beskyttelseskode.

Se under "Lock/unlock (Set up 551)".

552 Summetone

Giver mulighed for at justere summetonen.

Minimum	Maksimum	Default
0/off	10	10

DA

601 Reguleringsstrin



Gør det muligt at regulere et parameter med trin, som man selv kan skræddersy

Minimum	Maksimum	Default
1	Imax	1

602 Ekstern parameter CH1, CH2, CH3, CH4



Gør det muligt at styre den eksterne parameter 1, 2, 3, 4 (minimumværdi, maksimumværdi, defaultværdi, valgte parameter).

Se under "Styring fra eksternt udstyr (Set up 602)".

606 Brænder U/D



Gør det muligt at styre den eksterne parameter (U/D).

Værdi	Default	Tilbagekaldsfunktion
0/off	-	off
1/11	X	Strøm
	-	Hent program

612 Setting brænder DgTig



Tillader at administrere den digitale brænders kanaler.

Værdi	Default	Tilbagekaldsfunktion
0/off	-	off
1/11	-	Strøm
2/	-	Hent program
3/CH3	-	CH3
4/CH4	-	CH4
5/STD	X	STD

705 Justering af kredsløbsmodstand



Tillader at kalibrere anlægget.

Se under "Justering af kredsløbsmodstand (set up 705)".

751 Strømaflæsning



Gør det muligt at se den faktiske værdi for svejsestrømmen.

752 Spændings aflæsning



Gør det muligt at aflæse den faktiske værdi for svejse spænding.

758 Robothastighed



Gør det muligt at aflæse hastigheden for en robotarm eller andet automationudstyr.

764 Aflæsning af kølemedi flow



Muliggør visning af værdien for kølemedi flowet.

765 Aflæsning af kølemedi temperatur



Gør det muligt at se den faktiske værdi for kølemedi temperatur.

768 Måling af tilført termisk energi HI



Tillader aflæsning af værdien på den tilførte termiske energi i svejsningen.

DA

801 Stopgrænser





Gør det muligt at indstille advarselværdier og stopværdier.
 Gør det muligt at styre svejseprocessen ved at sætte advarselgrænser og stopgrænser for de vigtigste målbare parametre.
 Giver mulighed for nøje styring af de forskellige svejsefaser.

5.2 Specifikke procedurer for brug af parametrene

5.2.1 Skræddersy 7-segment displayet

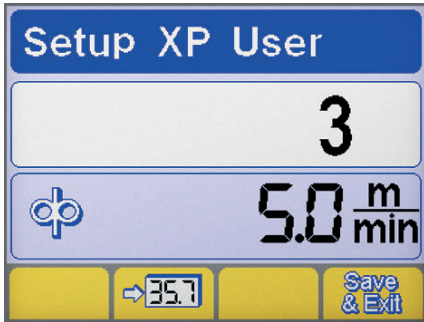
Giver mulighed for konstant at visualisere en parameterværdi på displayet med 7 segmenter.



- ▶ Gå ind i opsætning ved at holde encoderknappen nede i mindst 5 sekunder.
- ▶ Vælg det ønskede parameter ved at dreje encodern.
- ▶ Gem det valgte parameter i 7-segment displayet ved at trykke på knappen .
- ▶ Gem og gå ud af skærbilledet ved at trykke på knappen .

5.2.2 Skræddersyet interface (Set up 500)

Gør det muligt med personlig tilpasning af parametrene i hovedskærbilledet.

500 Indstilling af maskine



Gør det muligt at vælge den ønskede grafiske interface.





Værdi	Brugerinterface
XE	Tilstanden Easy
XA	Tilstanden Advanced
XP	Tilstanden Professional







TILSTAND XE

MMA

Vejseparametre 



TIG





Vejseparametre     

Funktioner      









TILSTAND XA







MMA

Vejseparametre   

Funktioner     

TIG

Vejseparametre        

Funktioner      

DA

TILSTAND XP

MMA	
Vejseparametre	
Funktioner	
TIG	
Vejseparametre	
Funktioner	

5.2.3 Lock/unlock (Set up 551)

Gør det muligt at låse kontrolpanelets indstillinger og at installere en beskyttelseskode.

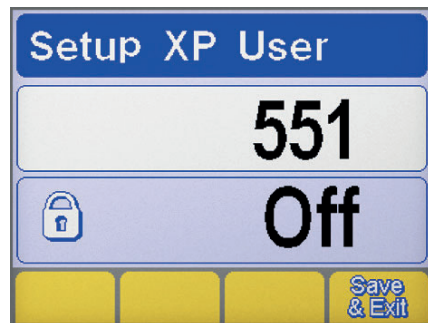

Parametermarkering

- ▶ Gå ind i opsætning ved at holde encoderknappen nede i mindst 5 sekunder.
- ▶ Vælg den ønskede parameter (551).
- ▶ Aktiver regulering af det valgte parameter ved at trykke på encoderknappen.

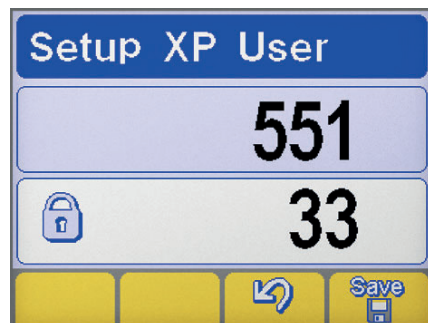

Indstilling af adgangskode

- ▶ Definer en numerisk kode (password) ved at dreje på encodern.
- ▶ Bekræft handlingen ved at trykke på encoder-tasten.
- ▶ Godkend ved at trykke på knappen .
- ▶ Modifikationen gemmes ved at trykke på knappen: .

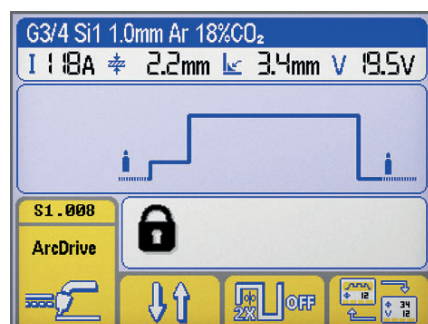

Panelfunktioner



Når en opgave udføres på et låst kontrolpanel, kommer der et specielt skærbillede frem.

- ▶ Gå ind i panelfunktionerne midlertidigt (5 minutter) ved at dreje endoceren og indtaste gyldigt password.
- ▶ Bekræft handlingen ved at trykke på encoder-tasten.
- ▶ Lås kontrolpanelet endeligt op ved at gå ind i opsætning (følg instrukserne ovenfor) og sæt parameter 551 tilbage på "off".
- ▶ Bekræft handlingen ved at trykke på encoder-tasten.
- ▶ Modifikationen gemmes ved at trykke på knappen: .

DA

5.2.4 Styring fra eksternt udstyr (Set up 602)

Gør det muligt at styre den eksterne parameter 2 (minimumværdi, maksimumværdi, defaultværdi, valgte parameter).

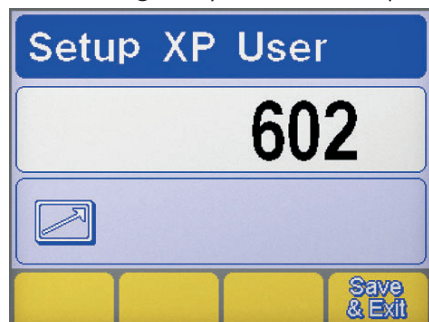

Parametermarkering

- ▶ Gå ind i opsætning ved at holde encoderknappen nede i mindst 5 sekunder.
- ▶ Vælg den ønskede parameter (602).
- ▶ Gå ind i "Styring fra eksternt udstyr" skærmen ved at trykke på encoderknappen.

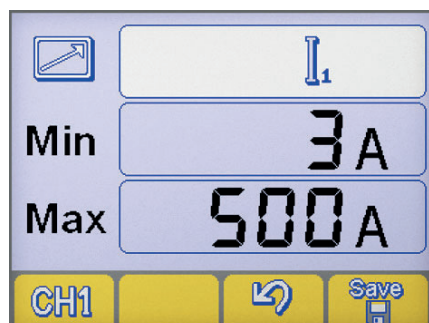

Styring fra eksternt udstyr

- ▶ Vælg den ønskede udgangskanal på fjernbetjeningen (CH1, CH2, CH3, CH4) ved at trykke på-knappen: **CH1**
- ▶ Vælg det ønskede parameter (Min-Max-parameter) ved at trykke på encoderknappen.
- ▶ Tilpas det valgte parameter (Min-Max-parameter) ved at dreje encoderen.
- ▶ Modifikationen gemmes ved at trykke på knappen: **Save**
- ▶ Godkend ved at trykke på knappen **↵**.

5.2.5 Justering af kredsløbsmodstand (set up 705)

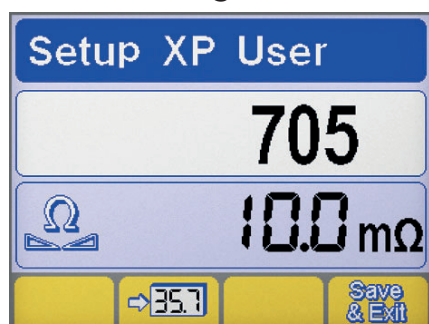

Parametermarkering

- ▶ Gå ind i opsætning ved at holde encoderknappen nede i mindst 5 sekunder.
- ▶ Vælg den ønskede parameter (705).
- ▶ Aktiver regulering af det valgte parameter ved at trykke på encoderknappen.

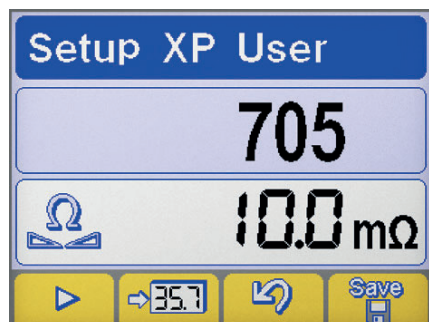

Kalibrering

- ▶ Bring tungstens elektrode og det emne, som skal svejses, i elektrisk kontakt. (TIG)
- ▶ Placer elektrodeholder brænderen og det stykke, der skal svejses, i kontak. (MMA)
- ▶ Tryk på knappen **▶** (eller brændertasten) for at starte proceduren.
- ▶ Oprethold kontakten i mindst et sekund.
- ▶ Den viste værdi på displayet opdateres efter kalibreringen.
- ▶ Godkend ved at trykke på knappen **Save**
- ▶ Godkend ved at trykke på knappen **↵**.
- ▶ Modifikationen gemmes og man forlader set up ved at trykke på tasten: **Save & Exit**.

5.2.6 Stopgrænser (Set up 801)

Gør det muligt at indstille advarselværdier og stopværdier.

Gør det muligt at styre svejseprocessen ved at sætte advarselgrænser og stopgrænser for de vigtigste målbare parametre.

Giver mulighed for nøje styring af de forskellige svejsefaser.

Se under "Stopgrænser (Set up 801)".

Advarselgrænser		⚠ MIN	⚠ MAX	Stopgrænser		⚠ MIN	⚠ MAX
I_i	Svejestrøm	V	Svejse spænding	↶↷	Aflæsning af gasflow	↶↷	Robothastighed
M₁	Strømaflæsning (motor 1)	M₂	Strømaflæsning (motor 2)				



Aflæsning af kølemedieflow



Tråd hastighed



Aflæsning af kølemedietemperatur

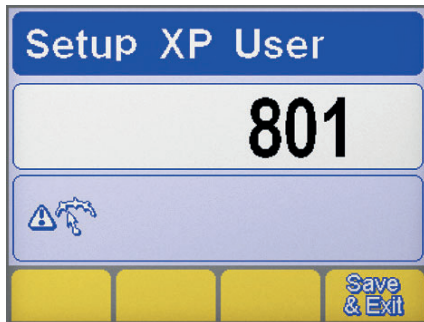

Parametermarkering

- ▶ Gå ind i opsætning ved at holde encoderknappen nede i mindst 5 sekunder.
- ▶ Vælg den ønskede parameter (801).
- ▶ Gå ind i "Stopgrænser" skærbilledet ved at trykke på encoderknappen.

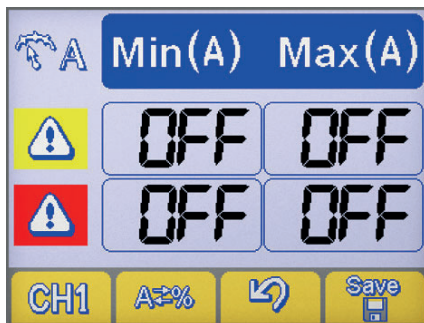

Markering af parameteren

- ▶ Vælg det ønskede parameter ved at trykke på knappen **CH1**.
- ▶ Vælg metode til at indstille stopgrænser ved at trykke på knappen **A=%**.



Indstilling af maskine



Absolut værdi



Procentværdi

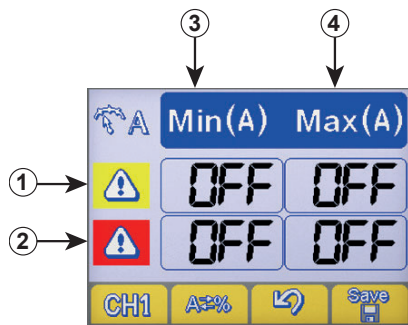

Indstilling af beskyttelsesgrænser

- 1 Advarselsgrænselinje
- 2 Alarmgrænselinje
- 3 Minimum-niveau søjle
- 4 Maksimum-niveau søjle

- ▶ Vælg den ønskede boks ved at trykke på encoderknappen (den valgte boks vises med modsat kontrast).
- ▶ Tilpas niveauet for den valgte grænse ved at dreje encodern.
- ▶ Modifikationen gemmes ved at trykke på knappen: **Save**.



Hvis en af advarselsgrænserne overskrives, vil et signal kunne ses på kontrolpanelet.



Hvis en af alarmgrænserne overskrides, vil et signal kunne ses på kontrolpanelet, og svejsningen blokeres omgående.



Det er muligt at indstille start og slut svejsefiltre, for at forhindre at fejlsignal går i gang, når buen hhv. tændes og slukkes (se under "Opsætning" - Parameter 802-803-804).



6. VEDLIGEHOEDElse



Anlægget skal undergå en rutinemæssig vedligeholdelse i henhold til fabrikantens anvisninger. Alle adgangslåger, åbninger og dæksler skal være lukket og korrekt fastgjort, når apparatet er i funktion. Der må aldrig udføres nogen form for ændringer på anlægget. Undgå ophobning af metalstøv i nærheden af eller direkte på udluftningsvingerne.



Al vedligeholdelse skal udelukkende udføres af kvalificeret personale. Reparation eller udskiftning af anlægselementer udført af uautoriseret personale medfører øjeblikkeligt bortfald af produktgarantien. Eventuel reparation eller udskiftning af anlægselementer må udelukkende udføres af teknisk kvalificeret personale.



Afbryd strømforsyningen til anlægget inden enhver form for indgreb!

6.1 Regelmæssig kontrol af strømkilden

6.1.1 Оборудование



Rengør strømkilden indvendigt ved hjælp af trykluft med lavt tryk og bløde børster. Kontrollér de elektriske tilslutninger og alle forbindelseskabler.

6.1.2 Ved vedligeholdelse eller udskiftning af komponenter i brænderne, i elektrodeholdertangen og/eller jordledningskablerne skal nedenstående fremgangsmåde overholdes:



Kontrollér temperaturen på komponenterne og sørg for, at de ikke er overopvarmet.



Anvend altid handsker, der opfylder sikkerhedsreglerne.



Anvend egnede nøgler og værktøj.

6.2 Vastuu



Ved manglende udførelse af ovennævnte vedligeholdelse vil alle garantier bortfalde, og fabrikanten vil i alle tilfælde være fritaget for alle former for ansvar. Fabrikanten fralægger sig ethvert ansvar, hvis operatøren ikke overholder disse forskrifter. Ret henvendelse til det nærmeste servicecenter ved enhver tvivl og/eller ethvert problem.

7. ALARMKODER



ALARM

























Indgriben fra en alarm eller overskridelsen af en kritisk beskyttelsesgrænse forårsager et visuelt signal på kontrolpanelet og den øjeblikkelige blokering af svejsningen.















PAS PÅ

Overskridning af en beskyttelsesgrænse medfører en visualisering af en signalering på kontrolpanelet, men tillader at fortsætte svejsehandlingerne.

Alle alarmer og alle beskyttelsesgrænser for systemet er angivet nedenfor.

 E01	Overtemperatur		 E02	Overtemperatur	
 E03	Overtemperatur		 E05	Overstrøm	
 E06	Overstrøm på effektmodul (Boost)		 E07	Anomali på trådfremføringsmotorens forsyningssystem	
 E08	Blokeret motor		 E10	Overstrøm på effektmodul (Inverter)	
 E11	Forkert konfiguration af anlæg		 E13	Kommunikationsfejl (FP)	
 E14.xx	Ugyldigt program underfejlkoden angiver nummeret på det slettede job		 E15	Ugyldigt program	

 E16	Kommunikationsfejl (RI) (Automation og robotstyring)		 E18.xx	Ugyldigt program underfejlkoden angiver nummeret på det slettede job	
 E19	Forkert konfiguration af anlæg		 E20	Hukommelse defekt	
 E21	Tab af data		 E22	Kommunikationsfejl (DSP)	
 E27	Hukommelse defekt (RTC)		 E29	Inkompatible mål	
 E30	Kommunikationsfejl (H.F.)		 E32	Tab af data	
 E33	Forkert konfiguration af anlæg (LCD 3.5")		 E38	Underspænding	
 E39	Anomali på anlæggets forsyning		 E40	Anomali på anlæggets forsyning	
 E41	Overspænding		 E42	Underspænding	
 E43	Kølevæskemangel		 E49	Nødafbryder (Automation og robotstyring)	
 E51	Ikke understøttede indstillinger (Automation og robotstyring)		 E52	Antikollision (Automation og robotstyring)	
 E53	Fejl, ekstern flowmåler (Automation og robotstyring)		 E54	Strømniveau overskredet (Nedre grænse)	
 E55	Strømniveau overskredet (Øvre grænse)		 E56	Overskredet spændingsniveau (Nedre grænse)	
 E57	Overskredet spændingsniveau (Øvre grænse)		 E58	Overskredet gasflowniveau (Nedre grænse)	
 E59	Overskredet gasflowniveau (Øvre grænse)		 E62	Strømniveau overskredet (Nedre grænse)	
 E63	Strømniveau overskredet (Øvre grænse)		 E64	Overskredet spændingsniveau (Nedre grænse)	
 E65	Overskredet spændingsniveau (Øvre grænse)		 E66	Overskredet gasflowniveau (Nedre grænse)	
 E67	Overskredet gasflowniveau (Øvre grænse)		 E71	Kølevæskeovertemperatur	

 E72	Overstrøm push-pull-motor		 E73	Overskredet trådhastighedsgrænse (speed meter)	
 E75	Overskredet motorstrømniveau 2		 E76	Overskredet kølevæskeflowniveau	
 E77	Kølevæsketemperaturniveau		 E78	Aktiv vedligeholdelse (Automation og robotstyring)	
 E81	Overstrøm (WU-pumpe)		 E82	Kommunikationsfejl (WU)	
 E83	Blokeret pumpe		 E99	Generel alarm	

8. FEJLFINDING OG LØSNINGER

Manglende tænding af anlægget (grøn kontrollampe slukket)

Årsag	Løsning
» Manglende ledningsnetsspænding i forsyningsstikket.	» Udfør en kontrol og foretag en reparation af det elektriske anlæg. » Benyt kun specialiseret personale.
» Defekt forsyningsstik eller -ledning.	» Udskift den defekte komponent. » Kontakt nærmeste servicecenter og lad anlægget reparere.
» Brændt linjesikring.	» Udskift den defekte komponent.
» Defekt tændingskontakt.	» Udskift den defekte komponent. » Kontakt nærmeste servicecenter og lad anlægget reparere.
» Defekt elektronik.	» Kontakt nærmeste servicecenter og lad anlægget reparere.

Manglende udgangseffekt (anlægget svejser ikke)

Årsag	Løsning
» Fejlbehæftet brænderknop.	» Udskift den defekte komponent. » Kontakt nærmeste servicecenter og lad anlægget reparere.
» Overophedet anlæg (termisk alarm - gul kontrollampe tændt).	» Afvent at anlægget køler af uden at slukke det.
» Ukorrekt tilslutning af jordforbindelsen.	» Udfør jordforbindelsestilslutningen korrekt. » Jævnfør afsnittet "Installation".
» Ledningsnetsspænding over interval (gul kontrollampe tændt).	» Bring ledningsnetsspændingen tilbage i strømkildens forsyningsinterval. » Udfør en korrekt tilslutning af anlægget. » Jævnfør afsnittet "Tilslutning".
» Defekt kontaktor.	» Udskift den defekte komponent. » Kontakt nærmeste servicecenter og lad anlægget reparere.
» Defekt elektronik.	» Kontakt nærmeste servicecenter og lad anlægget reparere.

Ukorrekt effektlevering

Årsag	Løsning
» Fejlagtig markering af svejseprocessen eller defekt omskifter.	» Udfør en korrekt markering af svejseprocessen.
» Fejlagtig indstilling af systemets parametre eller funktioner.	» Nulstil systemet og indstil svejseparametrene igen.
» Defekt potentiometer/encoder til regulering af svejsestrøm.	» Udskift den defekte komponent. » Kontakt nærmeste servicecenter og lad anlægget reparere.
» Ledningsnetsspænding over interval.	» Udfør en korrekt tilslutning af anlægget. » Jævnfør afsnittet "Tilslutning".

» Mangel af en fase.

» Udfør en korrekt tilslutning af anlægget.

» Jævnfør afsnittet "Tilslutning".

» Defekt elektronik.

» Kontakt nærmeste servicecenter og lad anlægget reparere.

Ustabil bue

Årsag

» Utilstrækkelig gasbeskyttelse.

Løsning

» Juster gasstrømmen.

» Kontroller, at brænderens spredner og gasdyse er i god stand.

» Fugtighedsforekomst i svejsegassen.

» Benyt altid produkter og materialer af god kvalitet.

» Sørg for at holde gasforsyningsanlægget i perfekt stand.

» Ukorrekte svejseparametre.

» Udfør en omhyggelig kontrol af svejseanlægget.

» Kontakt nærmeste servicecenter og lad anlægget reparere.

Overdreven sprøjt-udslyngning

Årsag

» Ukorrekt buelængde.

Løsning

» Reducer afstanden mellem elektrode og emne.

» Reducer svejsestrømmen.

» Ukorrekte svejseparametre.

» Reducer svejsestrømmen.

» Utilstrækkelig gasbeskyttelse.

» Juster gasstrømmen.

» Kontroller, at brænderens spredner og gasdyse er i god stand.

» Ukorrekt buedynamik.

» Forøg kredsløbets induktive værdi.

» Ukorrekt svejseafviklingstilstand.

» Reducer brænderens hældning.

Utilstrækkelig gennemtrængning

Årsag

» Ukorrekt svejseafviklingstilstand.

Løsning

» Reducer fremføringshastigheden under svejsning.

» Ukorrekte svejseparametre.

» Forøg svejse-/skærestrømmen.

» Uegnet elektrode.

» Benyt en elektrode med en mindre diameter.

» Ukorrekt forberedelse af kanterne.

» Forøg spaltens åbning.

» Ukorrekt tilslutning af jordforbindelsen.

» Udfør jordforbindelsestilslutningen korrekt.

» Jævnfør afsnittet "Installation".

» Emnerne, der skal svejses, er for store.

» Forøg svejse-/skærestrømmen.

Slaggeindslutning

Årsag

» Ukomplet bortbearbejdning af slaggen.

Løsning

» Udfør en omhyggelig rengøring af emnet, inden svejsningen udføres.

» Elektrodens diameter er for stor.

» Benyt en elektrode med en mindre diameter.

» Ukorrekt forberedelse af kanterne.

» Forøg spaltens åbning.

» Ukorrekt svejseafviklingstilstand.

» Reducer afstanden mellem elektrode og emne.

» Sørg for, at fremføringen er regelmæssig under alle svejsefaserne.

Tungsteninklusion

Årsag

» Ukorrekte svejseparametre.

Løsning

» Reducer svejsestrømmen.

» Benyt en elektrode med en større diameter.

» Uegnet elektrode.

» Benyt altid produkter og materialer af god kvalitet.

» Udfør en korrekt slibning af elektroden.

» Ukorrekt svejseafviklingstilstand.

» Undgå berøringer mellem elektrode og svejsebad.

Blæsning

Årsag

» Utilstrækkelig gasbeskyttelse.

Løsning

» Juster gasstrømmen.

» Kontroller, at brænderens spredner og gasdyse er i god stand.

Sammensmeltning

Årsag	Løsning
» Ukorrekt buelængde.	» Forøg afstanden mellem elektrode og emne. » Forøg svejse-spændingen.
» Ukorrekte svejseparametre.	» Forøg svejse-/skærestrømmen. » Forøg svejse-spændingen.
» Ukorrekt svejseafviklingstilstand.	» Tilpas vinklen på brænderens hældning.
» Emnerne, der skal svejses, er for store.	» Forøg svejse-/skærestrømmen. » Forøg svejse-spændingen.
» Ukorrekt buedynamik.	» Forøg kredsløbets induktive værdi.

Marginale graveringer

Årsag	Løsning
» Ukorrekte svejseparametre.	» Reducer svejsestrømmen. » Benyt en elektrode med en mindre diameter.
» Ukorrekt buelængde.	» Reducer afstanden mellem elektrode og emne. » Reducer svejse-spændingen.
» Ukorrekt svejseafviklingstilstand.	» Reducer sideoscillationshastigheden under påfyldning. » Reducer fremføringshastigheden under svejsning.
» Utilstrækkelig gasbeskyttelse.	» Benyt gas, der passer til det materiale, der skal svejses.

Oxideringer

Årsag	Løsning
» Utilstrækkelig gasbeskyttelse.	» Juster gasstrømmen. » Kontroller, at brænderens spreder og gasdyse er i god stand.

Porøsitet

Årsag	Løsning
» Tilstedeværelse af fedt, maling, rust eller snavs på de emner, der skal svejses.	» Udfør en omhyggelig rengøring af emnet, inden svejsningen udføres.
» Tilstedeværelse af fedt, maling, rust eller snavs på tilsatsmaterialet.	» Benyt altid produkter og materialer af god kvalitet. » Hold altid tilsatsmaterialet i perfekt stand.
» Fugtighedsforekomst i tilsatsmaterialet.	» Benyt altid produkter og materialer af god kvalitet. » Hold altid tilsatsmaterialet i perfekt stand.
» Ukorrekt buelængde.	» Reducer afstanden mellem elektrode og emne. » Reducer svejse-spændingen.
» Fugtighedsforekomst i svejsegassen.	» Benyt altid produkter og materialer af god kvalitet. » Sørg for at holde gasforsyningsanlægget i perfekt stand.
» Utilstrækkelig gasbeskyttelse.	» Juster gasstrømmen. » Kontroller, at brænderens spreder og gasdyse er i god stand.
» For hurtig størkning af svejsebadet.	» Reducer fremføringshastigheden under svejsning. » Udfør en forvarmning af de emner, der skal svejses. » Forøg svejse-/skærestrømmen.

Knagelyd ved opvarmning

Årsag	Løsning
» Ukorrekte svejseparametre.	» Reducer svejsestrømmen. » Benyt en elektrode med en mindre diameter.
» Tilstedeværelse af fedt, maling, rust eller snavs på de emner, der skal svejses.	» Udfør en omhyggelig rengøring af emnet, inden svejsningen udføres.
» Tilstedeværelse af fedt, maling, rust eller snavs på tilsatsmaterialet.	» Benyt altid produkter og materialer af god kvalitet. » Hold altid tilsatsmaterialet i perfekt stand.
» Ukorrekt svejseafviklingstilstand.	» Udfør de korrekte driftssekvenser til den sammenføjning, der skal svejses.
» De emner, der skal svejses, har forskellige egenskaber.	» Udfør en indsmøring, inden svejsningen udføres.

Knagelyd ved kolde emner

Årsag	Løsning
» Fugtighedsforekomst i tilsatsmaterialet.	» Benyt altid produkter og materialer af god kvalitet. » Hold altid tilsatsmaterialet i perfekt stand.
» Partikulær geometri i den sammenføjning, der skal svejses.	» Udfør en forvarmning af de emner, der skal svejses. » Udfør en eftervarmning. » Udfør de korrekte driftssekvenser til den sammenføjning, der skal svejses.

9. BETJENINGSVEJLEDNING

9.1 Svejsning med beklædt elektrode (MMA)

Forberedelse af kanterne

For at opnå gode resultater anbefales det at arbejde på rene dele uden oxydering, rust eller andre forurenende stoffer.

Valg af elektroden

Diameteren på den elektrode, der skal anvendes, afhænger af materialets tykkelse, af positionen, af sammenføjningstypen og af svejsefugen.

Elektroder med stor diameter kræver høj strøm med deraf følgende høj varmedannelse under svejsningen.

Beklædningstype	Egenskaber	Brug
Rutil	Let at anvende	Alle positioner
Sur	Høj smeltehastighed	Flade
Basisk	Høj kvalitet i sammenføjningen	Alle positioner

Valg af svejsestrømmen

Svejsestrømsområdet for den anvendte elektrodetype vil være specificeret på elektrodeemballagen af fabrikanten.

Tænding og opretholdelse af lysbuen

Den elektriske lysbue tændes ved at gnide elektrodens spids mod svejseemnet, der er forbundet til jordkablet og - når lysbuen er tændt - ved hurtigt at trække stangen tilbage til den normale svejseafstand.

Det vil normalt være nyttigt at have en højere indledende strøm i forhold til basis-svejsestrømmen (Hot Start) for at lette tændingen af lysbuen.

Når den elektriske lysbue er dannet, påbegyndes smeltningen af den midterste del af elektroden, der aflægges i dråbeform på svejseemnet.

Elektrodens eksterne beklædning leverer under brugen beskyttelsesgas til svejsningen, der således vil være af god kvalitet.

For at undgå at dråber af smeltet materiale ved kortslutning af elektroden med svejsebadet medfører slukning af lysbuen p.g.a. en utilsigtet tilnærmelse af de to enheder, vil det være hensigtsmæssigt at øge svejsestrømmen forbigående, indtil kortslutningen er afsluttet (Arc Force).

Hvis elektroden hænger fast i svejseemnet, vil det være hensigtsmæssigt at sænke kortslutningsstrømmen til minimum (antisticking).

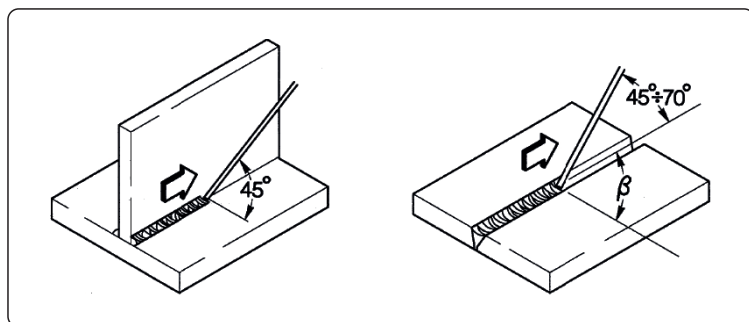

Udførelse af svejsningen

Elektrodens hældningsvinkel varierer afhængigt af antallet af afsættelser. Elektrodebevægelsen udføres normalt med svingninger og stop i siden af sømmen, således at man undgår for stor afsættelse af svejsemateriale i midten.

Fjernelse af slaggrer

Svejsning med beklædte elektroder kræver fjernelse af slaggrer efter hver svejse søm.

Slaggrerne kan fjernes ved hjælp af en lille hammer eller ved børstning, hvis det drejer sig om skøre slaggrer.

9.2 TIG-svejsning (kontinuerlig lysbue)

Beskrivelse

TIG-svejsemetoden (Tungsten Inert Gas) er baseret på princippet med en elektrisk lysbue, der tændes mellem en ikke smeltbar elektrode (ren eller legeret tungsten med smeltetemperatur på cirka 3370°C) og svejseemnet. En atmosfære af inaktiv gas (argon) sørger for beskyttelse af badet.

Derfor er svejsegeneratoren normalt udstyret med en anordning til tænding af lysbuen, der giver en høj frekvens og en høj spændingsudladning mellem spidsen af elektroden og svejseemnet. Takket være den elektriske gnist, der ioniserer gasatmosfæren, kan lysbuen derfor tændes uden nogen kontakt mellem elektroden og svejseemnet.

Der findes også en starttype med reduceret tungstentilføjelse: start med lift, der ikke kræver høj frekvens, men kun en indledende tilstand med kortslutning ved lav strøm mellem elektroden og emnet. I det øjeblik, hvor elektroden løftes, skabes lysbuen, og strømmen øges, indtil den når den indstillede svejseværdi.

For at forbedre kvaliteten af svejsevulstens afsluttende del er det hensigtsmæssigt at kunne betjene svejsestrømsænkningen med præcision, og det er nødvendigt, at gassen strømmer ned i svejsebadet endnu et par sekunder, efter at buen er gået ud.

Under mange arbejdsforhold er det hensigtsmæssigt at kunne råde over to forindstillede svejsestrømme og med lethed at kunne skifte fra den ene til den anden (BILEVEL).

Svejsepolaritet

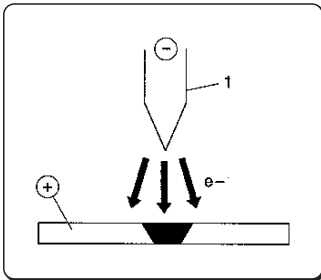

D.C.S.P. (Direct Current Straight Polarity)

Dette er den mest anvendte polaritet (direkte polaritet), der giver begrænset slid på elektroden (1), fordi 70 % af varmen koncentrerer på anoden (emnet).

Der fås smalle og dybe bade med høje fremføringshastigheder og lav varmetilførsel.

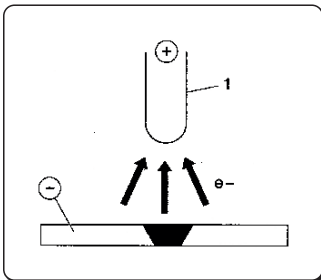

D.C.R.P. (Direct Current Reverse Polarity)

Omvendt polaritet bruges til svejsning af legeringer beklædt med et varmebestandigt oxydlag med en smeltetemperatur, der er højere end ved metal.

Der kan ikke anvendes høj strøm, fordi det vil medføre stort slid på elektroden.

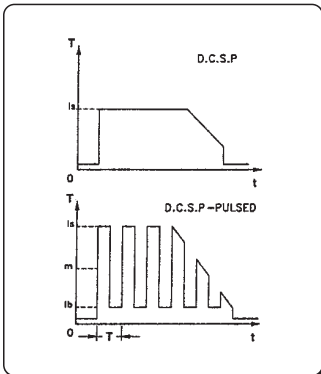

D.C.S.P.-Pulseret (Direct Current Straight Polarity Pulsed)

Når der anvendes en vedblivende pulseret strøm, opnås en bedre kontrol af svejsebadets bredde og dybde under specielle arbejdsforhold.

Svejsebadet formes af spidsimpulserne (I_p), hvorimod basisstrømmen (I_b) holder buen tændt. På denne måde bliver det nemmere at svejse tynde plader med mindre deformering, og der opnås en bedre formfaktor og dermed mindre fare for revner og gaseindtrængninger.

Når frekvensen forøges (middelfrekvens) opnås en smallere, mere koncentreret og mere stabil bue samt en højere svejsekvalitet ved tynde plader.

Egenskaberne ved TIG-svejsning

Tig-proceduren er meget effektiv ved svejsning af stål - både kulstål og legeringer - og ved første afsættelse på rør, samt ved svejsning, der kræver et optimalt udseende.

Der kræves direkte polaritet (D.C.S.P.).

Forberedelse af kanterne

Proceduren kræver omhyggelig rengøring og forberedelse af kanterne.

Valg og forberedelse af elektroden

Det anbefales at anvende thorium-tungstenelektroder (2 % thorium-rødfarvet) eller som alternativ, ceriums- eller lanthans-elektroder med de nedenstående diametre:

Strømområde			Elektrode	
(DC-)	(DC+)	(AC)	Ø	α
3-20 A	-	3-20 A	0,5 mm	30°
15-80 A	-	20-30 A	1,0 mm	30-60°
70-150 A	10-20 A	30-80 A	1,6 mm	60-90°
150-250 A	15-30 A	60-130 A	2,4 mm	90-120°
250-400 A	25-40 A	100-180 A	3,2 mm	120-150°
400-500 A	40-55 A	160-240 A	4,0 mm	150-180°
500-750 A	55-80 A	190-300 A	4,8 mm	150-180°
750-1100 A	80-125 A	325-450 A	6,4 mm	150-180°

Elektroden skal tilspidises som vist på illustrationen.

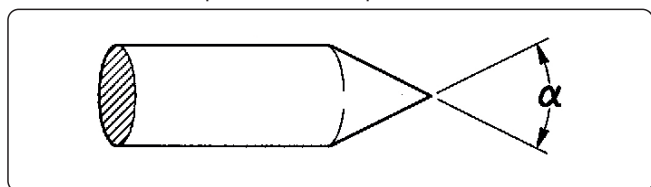

Svejestang

Svejestængerne skal have mekaniske egenskaber, der svarer til basismaterialets.

Undgå at bruge strimler fra basismaterialet, fordi de kan indeholde urenheder forårsaget af forarbejdningen, der kan få negativ indflydelse på svejsningen.

Beskyttelsesgas

Der anvendes i praksis altid ren argon (99,99 %).

Strømområde			Gas	
(DC-)	(DC+)	(AC)	Dyse	Flow
3-20 A	-	3-20 A	n° 4	5-6 l/min
15-80 A	-	20-30 A	n° 5	6-8 l/min
70-150 A	10-20 A	30-80 A	n° 6	7-10 l/min
150-250 A	15-30 A	60-130 A	n° 7	8-12 l/min
250-400 A	25-40 A	100-180 A	n° 8	10-14 l/min
400-500 A	40-55 A	160-240 A	n° 8	12-16 l/min
500-750 A	55-80 A	190-300 A	n° 10	15-20 l/min
750-1100 A	80-125 A	325-450 A	n° 12	20-25 l/min

DA

10. TEKNISKE SPECIFIKATIONER

Elektriske egenskaber			U.M.
Forsyningsspænding U1 (50/60 Hz)	3x230 (±15%)	3x400 (±15%)	Vac
Zmax (@PCC) *	53	53	mΩ
Forsinket linjesikring	25	16	A
Kommunikationstype	DIGITAL	DIGITAL	
Maks. effekt optaget	10.5	10.5	kVA
Maks. effekt optaget	10.1	10.1	kW
Absorberet effekt i inaktiv tilstand	51	51	W
Effektfaktor (PF)	0.96	0.96	
Ydeevne (μ)	83	83	%
Cos φ	0.99	0.99	
Maks. strøm optaget I1maks.	30.8	15.3	A
Effektiv strøm I1eff	18	9	A
Indstillingsområde	3-270	3-270	A
Spænding uden belastning Uo	80	80	Vdc
Spidsspænding Up	10.1	10.1	kV

* Dette udstyr opfylder EN / IEC 61000-3-11.

* Dette apparat overholder kravene ifølge normen EN / IEC 61000-3-12 hvis den største net-impedans tilladt ved grænsefladen med det offentlige net (fælles koblingspunkt - point of common coupling, pcc) er mindre end eller lig med den opgivne værdi "zmax". Såfremt udstyret skal tilsluttes et offentligt lavspændingsforsyningsnet, er det montørens eller brugerens ansvar at sikre, at udstyret kan tilsluttes; eventuelt ved henvendelse til el-selskabet.

Brugsfaktor	3x230V	3x400V	U.M.
Brugsfaktor (40°C)			
(X=35%)	270	270	A
(X=60%)	230	230	A
(X=100%)	180	180	A
Brugsfaktor (25°C)			
(X=80%)	270	270	A
(X=100%)	240	240	A

Fysiske egenskaber			U.M.
IP-beskyttelsesgrad	IP23S		
Isoleringsklasse	H		
Dimensioner (lxdxh)	500x190x400		mm
Vægt	18.8		Kg
Strømkabelsektion	4x4		mm ²
Længde af forsyningskabel	5		m
Bygningsstandarder	EN IEC 60974-1/A1:2019 EN IEC 60974-3:2019 EN 60974-10/A1:2015		

11. DATASKILT

VOESTALPINE BÖHLER WELDING SELCO S.R.L. Via Palladio, 19 - ONARA (PADOVA) - ITALY			
URANOS NX 2700 TLH		N°	
EN 60974-1/A1:2019 IEC 60974-10/A1:2015 Class A		60974-3:2019	
Up 10.1 kV 3A/10.0V - 270A (270A)/20.8V (20.8V)			
X (40°C)			
		35%	60%
		100%	
S	U ₀	I ₂	270A (270A) 230A (230A) 180A (180A)
	80V	U ₂	20.8V (20.8V) 19.2V (19.2V) 17.2V (17.2V)
3A/20.0V - 270A (270A)/30.8V (30.8V)			
X (40°C)			
		35%	60%
		100%	
S	U ₀	I ₂	270A (270A) 230A (230A) 180A (180A)
	80V	U ₂	30.8V (30.8V) 29.2V (29.2V) 27.2V (27.2V)
U ₁ 400V(230V)		I _{1max} 15.3A(30.8A)	I _{1eff} 9A(18A)
IP 23 S		CE UK CA EAC MADE IN ITALY	

12. BETYDNING AF OPLYSNINGERNE DATASKILT

1		2			
3		4			
5		6			
7	9	23			
		11			
		12	15	16	17
8	10	13	15A	16A	17A
		14	15B	16B	17B
7	9	11			
		12	15	16	17
8	10	13	15A	16A	17A
		14	15B	16B	17B
18	19	20	21		
22	CE UK CA EAC MADE IN ITALY				

- 1 Fremstillingsmærke
- 2 Navn og adresse på producenten
- 3 Apparatets model
- 4 Serienummer
X**XX**XXXXXXXXXX Produktionsår
- 5 Symbol for typen af svejseapparat
- 6 Henvisning til konstruktionsstandarder
- 7 Symbol for svejseprocessen
- 8 Symbol for svejsemaskiner egnet til arbejde i et miljø med øget risiko for elektrisk stød
- 9 Symbol for svejsestrøm
- 10 Nominel spænding i tomgang
- 11 Område for maksimal og minimum nominel svejsestrøm og den tilsvarende konventionelle belastningsspænding
- 12 Symbol for intermitterende cyklus
- 13 Symbol for nominel svejsestrøm
- 14 Symbol for nominel svejsestrøm
- 15 Værdier for intermitterende cyklus
- 16 Værdier for intermitterende cyklus
- 17 Værdier for intermitterende cyklus
- 15A Værdier for nominel svejsestrøm
- 16A Værdier for nominel svejsestrøm
- 17A Værdier for nominel svejsestrøm
- 15B Værdier for konventionel belastningsspænding
- 16B Værdier for konventionel belastningsspænding
- 17B Værdier for konventionel belastningsspænding
- 18 Symbol for strømforbrug
- 19 Nominel forbrugsspænding
- 20 Maksimal nominel strømforbrugsspænding
- 21 Maksimal faktisk strømforbrugsspænding
- 22 Beskyttelsesgrad
- 23 Nominel spidsspænding

CE EU-overensstemmelseserklæring
 EAC EAC-overensstemmelseserklæring
 UKCA UKCA-overensstemmelseserklæring

DA

EU-SAMSVARSERKLÆRING

Byggherren

voestalpine Böhler Welding Selco S.r.l. - Via Palladio, 19 - 35019 Onara di Tombolo (PD) - ITALY
Tel. +39 049 9413/111 - Fax +39 049 9413/311 - www.voestalpine.com/welding

erklærer under eget ansvar at følgende produkt:

URANOS NX 2700 TLH

55.07.042

55.07.043

er i samsvar med EU-direktivene:

2014/35/EU LOW VOLTAGE DIRECTIVE

2014/30/EU EMC DIRECTIVE

2011/65/EU RoHS DIRECTIVE

2019/1784/EU EcoDesign

2009/125/EU EcoDesign

og at følgende harmoniserte standarder er anvendt:

EN IEC 60974-1/A1:2019

WELDING POWER SOURCE

EN IEC 60974-3:2019

ARC STRIKING AND STABILIZING DEVICES

EN 60974-10/A1:2015

ELECTROMAGNETIC COMPATIBILITY REQUIREMENTS

Dokumentasjonen som bekrefter overholdelse av direktivene vil holdes tilgjengelig for inspeksjon hos den nevnte produsenten.

Ethvert inngrep eller forandring som ikke er autorisert av voestalpine Böhler Welding Selco S.r.l. ugyldiggjør denne erklæringen.

Onara di Tombolo, 01/07/2024

voestalpine Böhler Welding Selco s.r.l.



Mirco Frasson

Ivo Bonello

Managing Directors

INNHOLDSFORTEGNELSE

1. ADVARSEL	332
1.1 Bruksmiljø.....	332
1.2 Personlig beskyttelse og beskyttelse av tredje mann	332
1.3 Beskyttelse mot røyk og gass.....	333
1.4 For å forebygge brann/eksplosjoner.....	333
1.5 Forebyggelse ved bruk av gassbeholder	334
1.6 Vern mot elektrisk støt.....	334
1.7 Elektromagnetiske felt og forstyrrelser	334
1.8 Vernegrad IP	335
1.9 Avhending	335
2. INSTALLASJON.....	336
2.1 Løfting, transport og lossing.....	336
2.2 Plassering av anlegget	336
2.3 Kopling.....	336
2.4 Installasjon.....	337
3. PRESENTASJON AV ANLEGGET	338
3.1 Bakpanel.....	338
3.2 Støpselpanel	338
3.3 Frontpanel med kontroller	339
4. BRUK AV UTSTYRET.....	340
4.1 Startskjerm.....	340
4.2 Hovedskjerm.....	340
4.3 Hovedskjerm bilde MMA-prosess.....	340
5. INNSTILLING.....	344
5.1 Oppsett og innstillinger av parametrene	344
5.2 Spesifikke prosedyrer for bruk av parameterene.....	351
6. VEDLIKEHOLD	354
6.1 Utfør følgende periodiske inngrep på generatoren.....	355
6.2 Sorumluluk	355
7. ALARM KODER	355
8. DIAGNOSTIKK OG LØSNINGER.....	357
9. DRIFTSINSTRUKSJONER	360
9.1 Sveising med bekledd elektrode (MMA)	360
9.2 TIG-Sveising (kontinuerlig bue).....	361
10. TEKNISK SPESIFIKASJON.....	363
11. DATASKILT	364
12. BESKRIVELSE INFORMASJONSSKILT	364
13. SKJEMA.....	438
14. SKJØTEMUNNSTYKKER.....	440
15. LISTE OVER RESERVEDELER.....	441

SYMBOLENES FORKLARING



Advarsel



Forbud



Forpliktelser



Generelle indikasjoner

1. ADVARSEL



Før du begynner operasjonene, må du forsikre deg om å ha lest og forstått denne håndboka.

Utfør ikke modifikasjoner eller vedlikeholdsarbeid som ikke er beskrevet. Produsenten er ikke ansvarlig for skader på personer eller ting som oppstår på grunn av mangelfull forståelse eller manglende utførelse av instruksjonene i denne håndboka.

Bruksanvisningen skal alltid oppbevares der apparatet er i bruk. I tillegg til bruksanvisningen skal også generelle og lokale regler om ulykkesforebygging og miljø følges.

voestalpine Böhler Welding Selco S.r.l. forbeholder seg retten til å foreta forandringer når som helst og uten forvarsel.

Rettighetene for oversettelser, reproduksjon, tilpasning, helt eller delvis og med ethvert middel (deri innbefattet fotokopier, film og mikrofilm) er reserverte og forbudt uten skriftlig tillatelse av voestalpine Böhler Welding Selco S.r.l.

Disse retningslinjer er meget viktige og nødvendige for garantiens gyldighet.

Hvis operatøren ikke følger instruksene, frasier fabrikanten seg alt ansvar.



Alle personer som jobber med idriftsetting, betjening, vedlikehold og reparasjon av apparatet, skal:

- være tilsvarende kvalifisert
- ha kjennskap til sveising
- ha lest hele bruksanvisningen og følge denne

Ved tvil og problemer om bruken av anlegget, skal du henvende deg til kvalifisert personell.

1.1 Bruksmiljø



Alt utstyr skal kun brukes for operasjoner som det er prosjektert til, på den måte og i områdene som er angitt på skiltet og/eller i denne håndboka, i samsvar med nasjonale og internasjonale direktiver om sikkerhet. Bruk som skiller seg fra bruksmønster angitt av fabrikanten er ikke egnet og kan være farlig; i et slikt tilfelle frasier fabrikanten seg alt ansvar.



Denne enheten må brukes kun i profesjonelle applikasjoner i industrimiljøer. Fabrikanten er ikke ansvarlig for skader som er forårsaket ved privat bruk av anlegget.



Anlegget skal brukes i miljøer med en temperatur mellom -10°C og +40°C (mellom +14°F og +104°F).

Anlegget skal transporteres og oppbevares i miljøer med en temperatur mellom -25°C og +55°C (mellom -13°F og 131°F).

Anlegget skal brukes i miljøer fritt for støv, syre, gass eller andre etsende stoffer.

Anlegget må ikke brukes i miljøer med en luftfuktighet over 50% ved 40°C (104°F).

Anlegget må ikke brukes i miljøer med en luftfuktighet over 90% ved 20°C (68°F).

Anlegget må ikke brukes høyere enn 2000m over havet.



Ikke bruk denne typen apparat for å tine opp frosne rør.

Bruk aldri apparatet for å lade batterier og/eller akkumulatører.

Bruk ikke apparatet for å starte motorer.

1.2 Personlig beskyttelse og beskyttelse av tredje mann



Sveiseprosedyren kan danne farlig stråling, støy, varme og gass. Installer et brannsikkert skillerom for å beskytte sveisesonen fra stråler, gnister og glødende slagg. Advar alle mennesker i nærheten at de ikke må feste blikket på sveisebuen eller på det glødende metallet, og få en brukbar beskyttelse.



Ha på deg verneklær for å beskytte huden fra strålene, gnistene eller på det glødende metallet, og få en tilfredsstillende beskyttelse. Du må ha på deg egnet klær som dekker hele kroppen og er:

- hele og i god stand
- ikke brannfarlige
- isolerende og tørre
- tettsittende og uten mansjetter og oppbrett



Bruk alltid foreskrevne sko som er sterk og er garantert vanntett.



Bruk alltid foreskrevne hansker som isolerer mot elektrisitet og varme.



Bruk masker med sidebeskyttelser for ansiktet og egnet beskyttelsesfilter (minst NR10 eller mere) for øyene dine.



Ha alltid på deg vernebriller med sideskjermer spesielt under manuelle eller mekanisk fjerning av sveiseslagg.



Bruk aldri kontaktlinser!



Bruk hørselvern hvis sveiseprosedyren forårsaker farlig støy. Hvis støynivået overstiger de tillatte grensene, må du avgrense arbeidssonen og forsikre deg om at personene som befinner seg i sonen er utstyrt med hørselvern.



Hold alltid sidepanelene lukket under sveiseprosedyren. Du skal ikke utføre endringer på anlegget.



Unngå å røre ved delene som du nettopp har sveiset, da den høye temperaturen kan føre til alvorlige forbrenninger eller skader.



Følg alle forholdsregler som er beskrevet også i bearbeidelsene etter sveisingen, da stykkene som du sveiset kan gi fra seg slaggrester mens de avkjøles.



Forsikre deg om at sveisebrenneren er avkjølet før du utfører arbeid eller vedlikehold på den.



Forsikre deg om at kjøleaggregatet er slått av før du frakopler slanger for tilførsel og retur av kjølevæsken. Den varme væsken som kommer ut kan føre til alvorlige forbrenninger eller skålding.



Forsikre deg om at det finnes et førstehjelpskrin i nærheten.
Ikke undervurder forbrenninger eller sår.



Før du forlater arbeidsplassen, skal du forsikre deg om at sonen er sikker for å forhindre ulykker som kan føre til skader på utstyr eller personer.

1.3 Beskyttelse mot røyk og gass



Røyk, gass og støv som dannes under sveisingen kan være farlige for helsen.
Røyken som blir produsert under sveiseprosedyren kan føre til kreft eller fosterskade på kvinner som er gravide.

- Hold hodet borte fra sveisegass og sveiserøyk.
- Forsikre deg om at ventilasjonen er fullgod, naturlig eller luftkondisjonering, i arbeidssonen.
- Ved utilstrekkelig ventilasjon, skal du bruke ansiktsmaske med luftfilter.
- Ved sveising i trange miljøer, anbefaler vi deg å ha oppsyn med operatøren ved hjelp av en kollega som befinner seg ute.
- Bruk aldri oksygen for ventilasjon.
- Kontroller oppsugets effektivitet ved regelmessig å kontrollere mengden av skadelig gass som blir fjernet i forhold til verdiene fastsatt i sikkerhetsnormene.
- Mengden og farlighetsgraden av røyken som blir generert beror på basismaterialet som blir brukt, støttematerialet og alle eventuelle stoffer som er brukt for rengjøring og fjerning av fett fra stykkene som skal sveises. Følg nøye instruksene fra fabrikanten og tilhørende tekniske spesifikasjoner.
- Utfør ikke sveiseprosedyren i nærheten av plasser hvor avfetting eller maling skjer.
- Plasser gassbeholdere utendørs eller på en plass med god luftsirkulasjon.

1.4 For å forebygge brann/eksplosjoner



Sveiseprosedyren kan forårsake brann og/eller eksplosjoner.

- Fjern alle brannfarlige eller lettantennlige materialer eller gjenstander fra arbeidssonen.
- Brannfarlige stoffer må være på minst 11 meters avstand fra sveisemiljøet og beskyttes på egnet måte.
- Gnistsprut og glødende partikler kan lett nå sonene rundt enheten også gjennom små åpninger. Vær spesielt forsiktig med å beskytte gjenstander og personer.
- Utfør ikke sveisingen på eller i nærheten av trykkbeholdere.

- Utfør ikke sveiseoperasjoner på lukkede beholdere eller rør. Vær meget forsiktig ved sveising av rør eller beholdere selv om de er åpen, tørt og rengjort med stor omhu. Rester av gass, drivstoff, olje eller lignende kan føre til eksplosjon.
- Du skal ikke sveise i miljøer hvor det er støv, gass eller eksplosiv damp.
- Etter sveisingen skal du forsikre deg om at kretsen under spenning ikke kan komme bort i delene som er koplet til jordledningskretsen.
- Plasser et brannslukningsapparat i nærheten av maskinen.

1.5 Forebygging ved bruk av gassbeholder



Inerte gassbeholdere inneholder gass under trykk og kan eksplodere hvis du ikke sikrer forholdene for transport, vedlikehold og bruk.

- Gassbeholderne skal være festet vertikalt ved veggen eller andre støtteinnretninger for å unngå fall og plutselige mekaniske støt.
- Stram verneheten på ventilen under transport, oppstart og hver gang du avslutter sveiseprosedyren.
- Unngå å utsette beholderne direkte for solstråler, plutselige temperaturforandringer, for høye eller ekstreme temperaturer. Utsett ikke gassbeholderne for altfor høye eller lave temperaturer.
- Hold beholderne vekk fra flammer, elektriske buer, sveisebrennere eller elektrodeholdetenger og glødende deler som fremkommer under sveiseprosedyren.
- Hold beholderne borte fra sveisekretsene og strømkretsene generelt.
- Hold hodet borte fra gassutslippet når du åpner beholderens ventil.
- Lukk alltid beholderens ventil når du avslutter sveiseprosedyrene.
- Utfør aldri sveising på en gassbeholder under trykk.
- Kople aldri en trykkluftbeholder direkte til maskinens reduksjonsventil! Trykket kan overstige reduksjonsventilens kapasitet og eksplodere!

1.6 Vern mot elektrisk støt



Et elektrisk støt kan være dødelig.

- Unngå å røre ved innvendige eller utvendige deler som er forsynt med strøm i sveise mens anlegget er slått på (sveisebrenner, tenger, jordledninger, elektroder, ledninger, ruller og spoler er elektrisk koplet til sveisekretsen).
- Forsikre deg om at anleggets og operatørens elektriske isolering er korrekt ved å bruke tørre steder og gulv som skal være tilstrekkelig isolert fra jord.
- Forsikre deg om at anlegget er korrekt koplet til uttaket og at nettet er utstyrt med en jordforbindelse.
- Berør aldri samtidig to sveisebrennere eller to elektrodeholdertenger.
- Avbryt umiddelbart sveiseprosedyren hvis du føler elektriske støt.



Enheten for buetenning og stabilisering er laget for manuell eller mekanisk styrt operasjon.



Forlengelse av brenner- eller sveisekablene mere enn 8 m vil øke risikoen for elektrisk støt.

1.7 Elektromagnetiske felt og forstyrrelser



Strømmen gjennom de innvendige og utvendige kablene i anlegget danner elektromagnetiske felt i nærheten av sveisekablene og anlegget.

- De elektromagnetiske feltene kan ha innvirkning på helsen til operatører som er utsatt for feltene under lange perioder (nøyaktig påvirkning er idag ukjent).
- De elektromagnetiske feltene kan påvirke andre apparater som pacemaker eller høreapparater.



Alle personer som har livsviktige elektroniske apparater (pace-maker) må henvende seg til legen før de nærmer seg soner hvor sveiseoperasjonene.

1.7.1 EMC overensstemmelse med: EN 60974-10/A1:2015.



Utstyr klasse B er i overensstemmelse med elektromagnetiske kompatibilitetskrav i industriell og beboelsesmiljø, inkludert boligområder hvor den elektriske kraft er forsynt fra det offentlige lavspennings forsyningssystem.



Utstyr klasse A er ikke ment for bruk i boligområder hvor den elektriske kraft er forsynt fra det offentlige lavspennings forsyningssystem. Det kan være potensielle vanskeligheter i å sikre elektromagnetisk kompatibilitet av utstyr klasse A i disse områder, på grunn av styrte såvel som utstrålte forstyrrelser.

For mer informasjon, se kapitlet: DATASKILT eller TEKNISK SPESIFIKASJON.

1.7.2 Installasjon, bruk og vurdering av området

Dette apparatet er konstruert i samsvar med kravene i den harmoniserte normen EN 60974-10/A1:2015 og er identifisert som "KLASSE A". Denne enheten må brukes kun i profesjonelle applikasjoner i industrimiljøer. Fabrikanten er ikke ansvarlig for skader som er forårsaket ved privat bruk av anlegget.



Brukeren må ha erfaringer i sektoren og er ansvarlig for installasjonen og bruken av enheten i overensstemmelse med fabrikantens anvisninger. Hvis elektromagnetiske forstyrrelser oppstår, er det brukeren som må løse problemet, om nødvendig ved hjelp av fabrikantens tekniske assistanse.



Uansett må de elektromagnetiske forstyrrelsene bli redusert slik at de ikke utgjør et problem.



Før du installerer denne enheten, må du ta i betraktning mulige elektromagnetiske problemer som kan oppstå i området og som kan være farlige for personene som er i området, f.eks. personer som bruker pace-maker eller høreapparater.

1.7.3 Krav hovedforsyning

Høyeffektutstyr kan, på grunn av primærstrøm trukket fra hovedforsyningen, influere på kraftkvaliteten på nettet. Derfor, tilkoplingsrestriksjoner eller krav angående maksimum tillatt impedanse på nettet (Z_{max}) eller den nødvendige minimum forsyningskapasitet (S_{sc}) på grensesnittspunktet til det offentlige nett (punkt for felles sammenkopling, PCC), kan bli brukt for enkelte typer utstyr (se tekniske data). I slike tilfeller er ansvaret hos installatør eller bruker av utstyret for å forsikre seg om, ved å konsultere operatøren av forsyningsnettverket om nødvendig, at utstyret kan tilkoples. I tilfelle av forstyrrelser, kan det være nødvendig å utføre andre operasjoner, som f.eks. filtrering av strømforsyningen fra elnettet.

Du må også kontrollere muligheten av å skjerme nettkabelen.

For mer informasjon, se kapittelet: TEKNISK SPESIFIKASJON.

1.7.4 Forholdsregler for kabler

For å minke effektene av elektromagnetiske felt, skal du følge disse reglene:

- Hvis mulig skal du bunte sammen jordledningen og nettkabelen.
- Aldri tvinn kablene rundt kroppen.
- Unngå å stille deg mellom jordledningen og nettkabelen (hold begge kablene på samme side).
- Kablene skal være så korte som mulig, og plasseres så nær hverandre som mulig og lagt på eller omtrentlig på gulvnivået.
- Plasser anlegget på noe avstand fra sveiseområdet.
- Kablene plasseres på avstand fra eventuelle andre kabler.

1.7.5 Jording

Jording av alle metallkomponenter i sveiseanlegget og dens miljø må tas i betraktning. Følg nasjonale og lokale forskrifter for jording.

1.7.6 Jording av delen som skal bearbeides

Hvis delen som skal bearbeides ikke er jordnet av elektriske sikkerhetsgrunner eller på grunn av dens dimensjoner og plassering, kan du bruke en jordledning mellom selve delen og jordkontakten for å minke forstyrrelsene. Vær meget nøye med å kontrollere at jordingen av delen som skal bearbeides ikke øker risikoen for ulykker for brukerne eller risikoen for skader på andre elektriske apparater. Følg gjeldende nasjonale og lokale forskrifter for jording.

1.7.7 Skjerming

Skjerming av andre kabler og apparater i nærheten kan redusere problemet med forstyrrelser.

Skjerming av hele sveiseanlegget kan være nødvendig for spesielle applikasjoner.

1.8 Vernegrad IP



IP23S

- Innhold som er beskyttet mot tilgang til farlige deler med fingrene og innføring av massive fremmedlegemer med en diameter som overstiger/er lik 12,5 mm.
- Innholdet er beskyttet mot regn i en skråvinkel på 60°.
- Innholdet er beskyttet mot skadelige effekter grunnet inntrenging av vann, når apparatets bevegelige deler ikke er igang.

1.9 Avhending



Ikke sluttbehandle apparatet som usortert kommunalt avfall!

I samsvar med EU-direktiv 2012/19/EU om avfall fra elektrisk og elektronisk utstyr og implementering av direktivet i samsvar med nasjonal lovgivning, skal elektrisk utstyr ved levetidens utløp innsamles separat og leveres inn til et innsamlingscenter. Eieren av utstyret må kontakte de lokale myndighetene for informasjon om nærmeste innsamlingscenter. Anvendelsen av EU-direktivet vil forbedre miljøet og menneskehelsen.

» Gå inn på nettstedet for mer informasjon.

2. INSTALLASJON



Installasjonen kan kun utføres av profesjonelt personale som er autorisert av fabrikanten.



Under installasjonen, skal du forsikre deg om at generatoren er frakoplet.



Det er forbudt å kople sammen (serie eller parallelt) generatorer.

2.1 Løfting, transport og lossing

- Anlegget er utstyrt med et håndtak som muliggjør manuell transporterung.



Ikke undervurder anleggets vekt, (se teknisk spesifikasjon).
Ikke la lasten beveges eller henges over personer eller ting.
Ikke dropp eller belaste anlegget med unødvendig tyngde.

2.2 Plassering av anlegget



Følg disse reglene:

- Gi lett adgang til kontrollene og kontaktene.
- Plasser ikke utstyret i trange rom.
- Sett aldri anlegget på en flate med en skråning som overstiger 100 fall.
- Plasser anlegget på en tørr og ren plass med tilstrekkelig ventilasjon.
- Beskytt anlegget mot regn og sol.

2.3 Kopling



Strømforsyningen er utstyrt med en nettkabel som skal koples til nettet.

Anlegget kan forsynes som følger:

- 230V trefase
- 400V trefase

Apparatets funksjon er garantert for spenninger som skiller seg maks. $\pm 15\%$ fra nominell verdi.



For å unngå skader på personer eller på anlegget, skal du kontrollere den nettspenning som er valgt, og sikringene, FØR du kople maskinen til nettet. Dessuten skal du forsikre deg om at kabelen blir koplet til et uttak med jordkontakt.



Det er mulig å forsyne anlegget ved hjelp av et aggregat, hvis denne garanterer en stabil strømforsyning $\pm 15\%$ i forhold til nominell spenningsverdi som er angitt av fabrikanten i alle mulige bruksforhold og med maksimal effekt som gis fra generatoren. I alminnelighet anbefaler vi bruk av aggregat med en effekt tilsvarende 2 ganger generatorens effekt hvis du bruker et enfasesystem eller 1,5 ganger effekten hvis du bruker et trefasesystem. Vi anbefaler deg å bruke aggregater med elektronisk kontroll.



For beskyttelse av brukeren, skal anlegget være korrekt koplet til jord. Nettkabelen er utstyrt med en ledning (gul/grønn) for jordledning og den skal koples til en kontakt utstyrt med jordforbindelse. Denne gul/grønne kabel må ALDRI brukes sammen med andre ledere for spenningskoplinger. Sjekk at anlegget er jordet og at stikkkontakten er i god stand. Bruk bare typegodkjente støpsler i samsvar med sikkerhetsforskriftene.



El-anlegget må settes opp av teknisk kyndig personale, hvis tekniske arbeidskunnskaper er spesifikke og i samsvar med lovgivningen i det landet der installasjonen utføres.

2.4 Installasjon

2.4.1 Tilkobling for MMA-sveising



Tilkoblingen utført som i illustrasjonen gir som resultat sveising med omvendt polaritet. For å kunne sveise med direkte polaritet må man koble om.

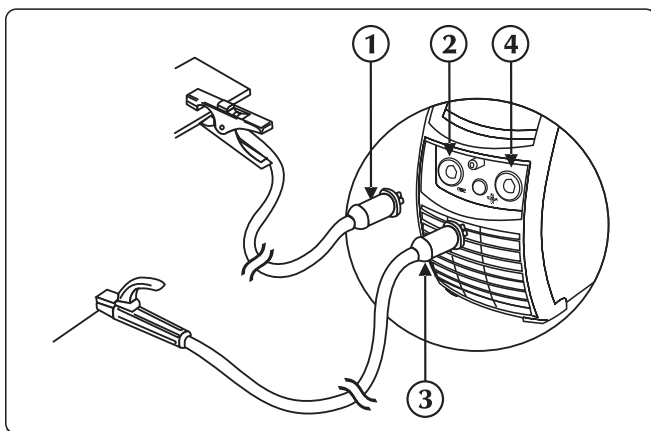



- ① Jordklemmekontakt
- ② Negativt strømuttak (-)
- ③ Kontakt for elektrodeholderklemme
- ④ Positivt strømuttak (+)

- ▶ Kopl jordklemmen til den negative sokkelen (-) på strømkilden. Sett inn kontakten og dreii den med klokken til delene er helt sikret.
- ▶ Kopl elektrodeholderen til den positive sokkelen (+) på strømkilden. Sett inn kontakten og dreii den med klokken til delene er helt sikret.

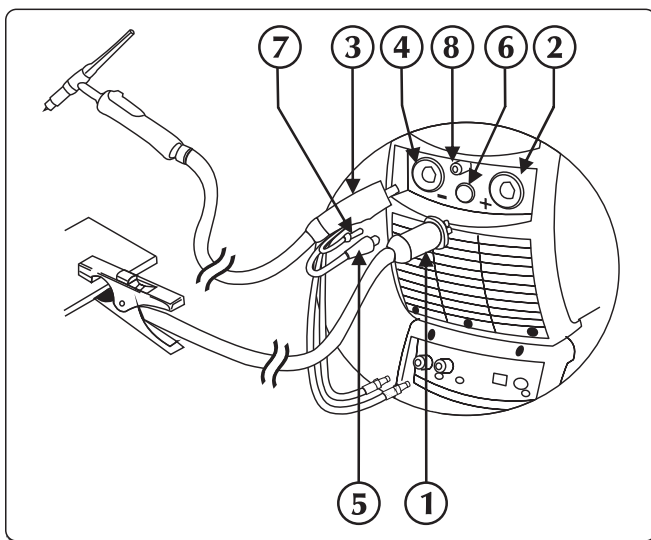
2.4.2 Tilkobling for TIG-sveising



- ① Jordklemmekontakt
- ② Positivt strømuttak (+)
- ③ TIG brennerens feste
- ④ Fakkeltstikkontakt
- ⑤ Brenneren signalkabelen
- ⑥ Kontakt
- ⑦ Fakkelt gassrør
- ⑧ Union/tilkopling gas

- ▶ Kopl jordklemmen til den positive sokkelen (+) på strømkilden. Sett inn kontakten og dreii den med klokken til delene er helt sikret.
- ▶ Kopl TIG brennerkopling til brennersokkelen på strømkilden. Sett inn kontakten og dreii den med klokken til delene er helt sikret.
- ▶ Kopl signalkabelen fra brenneren til tilhørende konnektor.
- ▶ Kopl gasslangen fra brenneren til den tilhørende union/tilkopling.
- ▶ Kople vannslangen fra sveisebrenneren (rød farge) til hurtigkoplings (rød farge ) inntak på kjøleenheten.
- ▶ Kople vannslangen fra sveisebrenneren (blå farge) til hurtigkoplings (blå farge ) uttak på kjøleenheten.

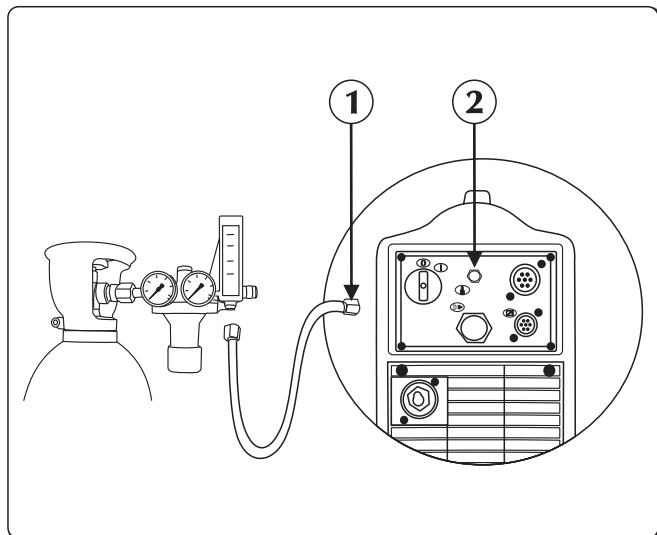

- ① Gassrør
- ② Union/tilkoping gas

► Kople gasslangen fra beholderen til gasslangen bak. Reguler gassflyten mellom 5 til 15 l/min.

3. PRESENTASJON AV ANLEGGET

3.1 Bakpanel

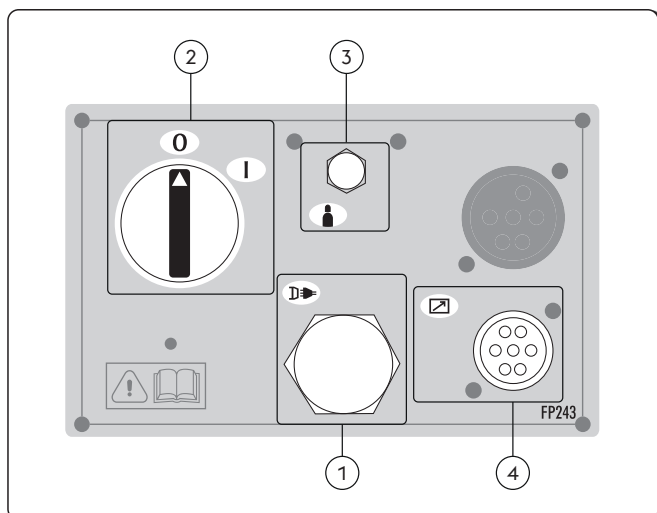

- ① **Strømforsyningskabel**
For å forsyne anlegget med strøm ved koping til nettet.
- ② **Av/PÅ-bryter**
Styrer den elektriske påslåingen av anlegget. Den har to posisjoner "0" slått av; "I" slått på.
- ③ **Gassfeste**
- ④ **Signalkabel CAN-BUS inngang (RC, RI...)**



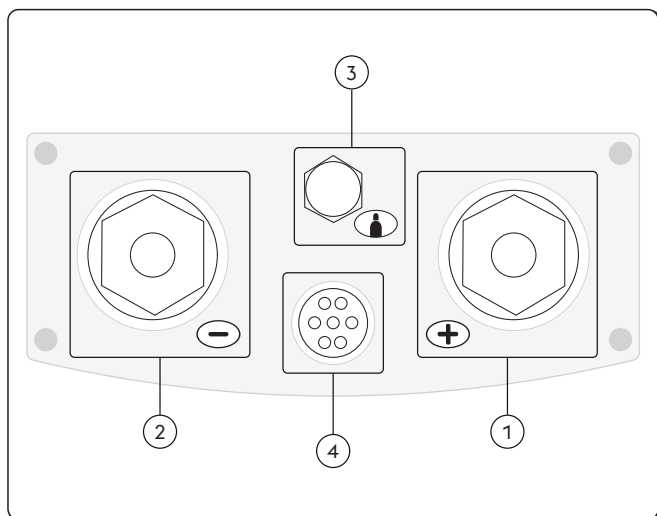



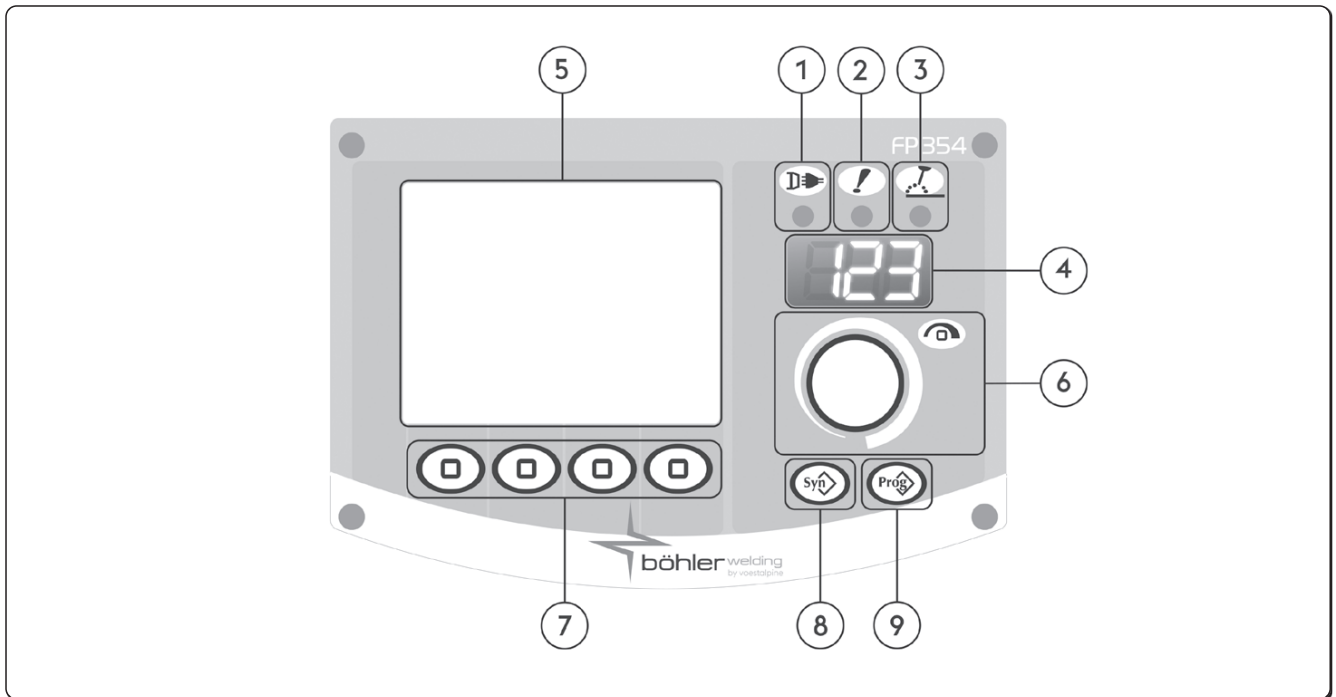

3.2 Støpselpanel







- ① **Positivt strømuttak (+)**
Prosess MMA: Tilkobling elektrodellommelykt
Prosess TIG: Tilkobling jordkabel
- ② **Negativt strømuttak (-)**
Prosess MMA: Tilkobling jordkabel
Prosess TIG: Tilkobling av sveisebrenner
- ③ **Gassfeste**
- ④ **Inngang signalkabel (TIG sveisebrenner)**

3.3 Frontpanel med kontroller

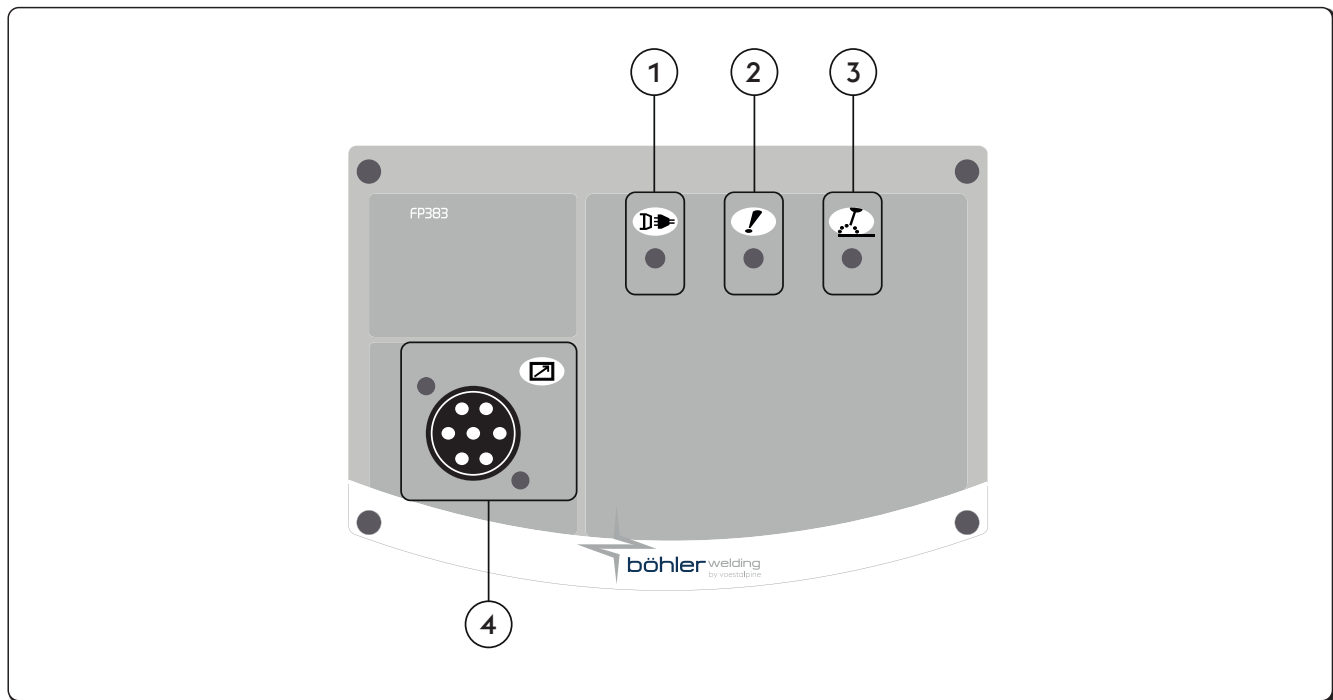

- 1  **LED for strømtilførsel**
Viser at utstyret er tilkoplek nettet og er på.
- 2  **LED for generell alarm**
Indikerer mulig påvirkning av en beskyttelsesenhet så som temperaturbeskyttelse.
- 3  **LED for aktivert effekt**
Indikerer at det er spenning på utstyrets spenningsuttak.
- 4  **7-segment skjerm**
Viser de generelle sveisemaskinparametrene under oppstart, settinger, strøm og spenningsverdier under sveising, og koding av alarmer.
- 5  **LCD skjerm**
Viser de generelle sveisemaskinparametrene under oppstart, settinger, strøm og spenningsverdier under sveising, og koding av alarmer.
Tillater alle operasjoner å bli vist øyeblikkelig.
- 6  **Hovedjusteringshendelen**
Muliggjør kontinuerlig å kunne justere sveise-strømmen.
Tillater å tilføre oppsett, valg og setting av sveiseparameter.
- 7  **Funksjonsknapp**
Lar deg velge forskjellige systemfunksjoner:
- Sveiseprosess
- Sveisemetoder
- Strømpulsing
- Grafisk metode
- 8  **Knapp ikke brukt**
- 9  **Job-tast**
Tillater lagring og administrasjon av 240 job som kan personaliseres av operatøren.



- 1  LED for strømtilførsel
Viser at utstyret er tilkoplett nettet og er på.
- 2  LED for generell alarm
Indikerer mulig påvirkning av en beskyttelsesenhet så som temperaturbeskyttelse.
- 3  LED for aktivert effekt
Indikerer at det er spenning på utstyrets spenningsuttak.
- 4  Signalkabel CAN-BUS inngang (RC, RI...)

4. BRUK AV UTSTYRET

4.1 Startskjerm

Når anlegget slås på, utfører det en rekke kontroller for å garantere korrekt funksjon av anlegget og alle tilkoblede enheter. På dette trinn utføres også gassstesten for å sjekke riktig tilkøpling til gassforsyningssystemet.

4.2 Hovedskjerm

Tillater kontroll av systemet og av sveiseprosessen ved å vise hovedsettingene.

4.3 Hovedskjerm bilde MMA-prosess

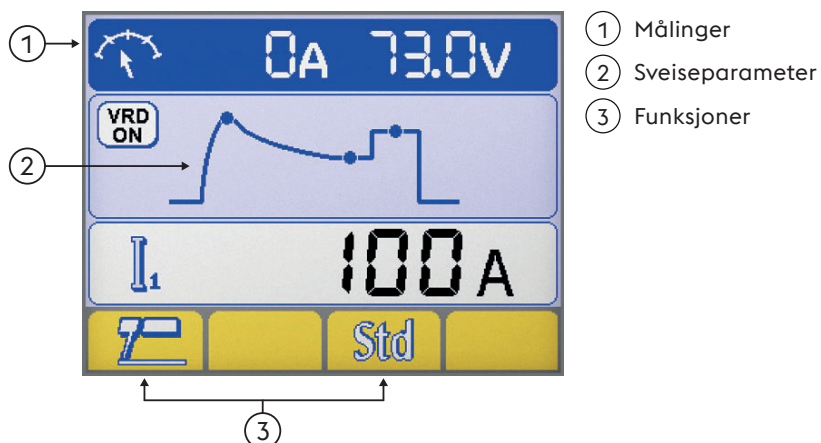

Målinger

Under sveiseoperasjonen, er reell strøm og spenningsmålinger vist på LCD-skjermen.



- ① Sveisestrøm
- ② Sveisespenning

Sveiseparameter

► Velg det ønskede parameter ved å trykke på encoderknappen.

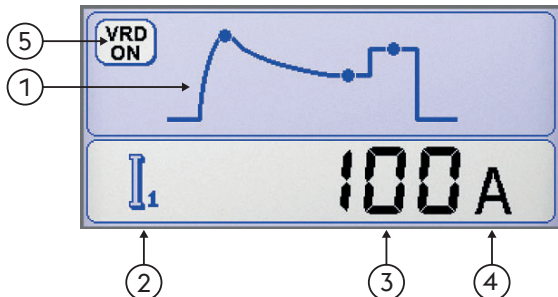

- ① Sveiseparameter
- ② Parameter ikon
- ③ Parameter verdi
- ④ Måleenhet for parameteret
- ⑤ VRD (Voltage Reduction Device) Spennings Reduksjonsenhet
Viser at ubelastet spenning på utstyret er under kontroll.

Funksjoner

Tillater setting av de mest viktige prosessfunksjonene og sveisemetoder.



- ① Sveiseprosess
- ② MMA-synergi



Sveiseprosess



MMA



TIG DC



MMA-synergi

For å stille in den beste buedynamikken ved å velge brukte elektrodetype.

Ved å velge korrekt buedynamikk oppnås maksimum fordeler å bli utledet fra spenningstilførselen i den hensikt å oppnå den best mulige sveiseytelse.



Standard
(Basisk/Rutil)



Cellulose



Stål



Aluminium



Støpjern



Perfekt sveiseresultat med den brukte elektrode er ikke garantert.

Sveiseresultat avhenger av kvaliteten på slitedeler og deres oppbevaring, operasjons- og sveiseforhold, tallrike mulige applikasjoner etc.

4.4 Hovedskjerm bilde TIG-prosess



Målinger

Under sveiseoperasjonen, er reell strøm og spenningsmålinger vist på LCD-skjermen.

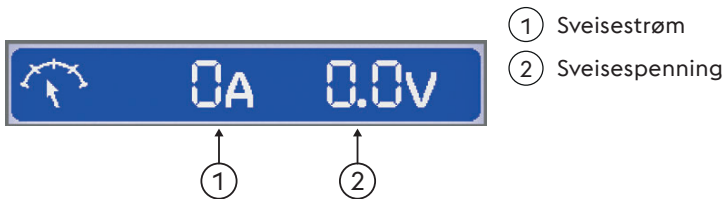

Sveiseparameter

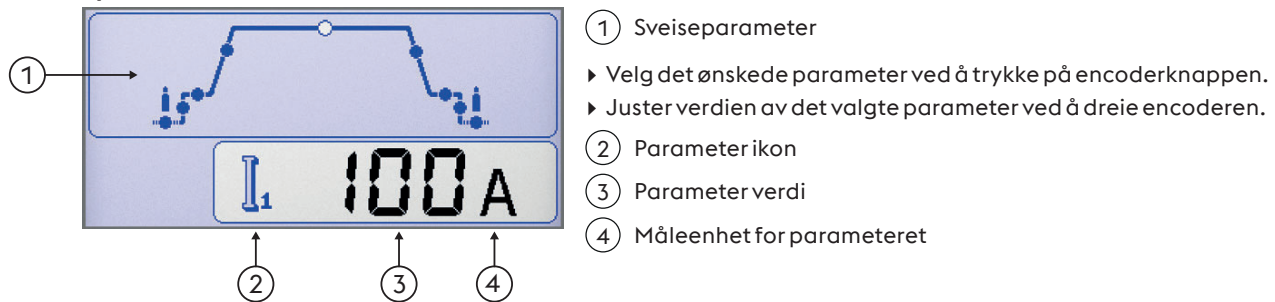

Funksjoner

Tillater setting av de mest viktige prosessfunksjonene og sveisemetoder.

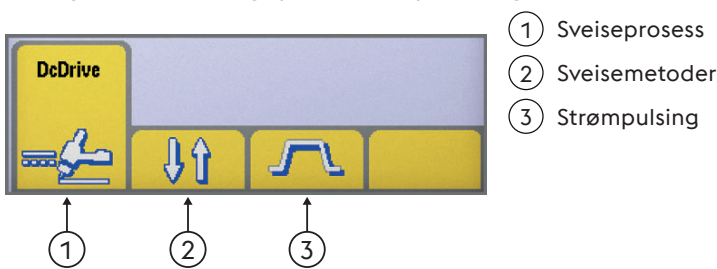

Sveiseprosess



Sveisemetoder

Gir valg av sveisemetoden





4 Trinn

I 4 Trinn vil det første trykket på knappen få gassen til å flyte, utfører en manuell pre-gass; når den slippes, tenner buen.



Bilevel

I bilevel kan sveiseren sveise med ulike strømmer som er innstilt tidligere. Det første trykket på knappen gir pre-gasstid, tenning av buen og sveising med den innledende strøm. Den første frislipp av knappen fører til strømstigning "I1". Hvis sveiseren trykker og slipper knappen raskt, skjer det en forandring til "I2". Trykking og slippe knappen raskt returnerer til "I1" og så videre. Hvis du trykker i en lengre tid, begynner senkingen av strømmen til sluttstrømmen. Ved å slippe knappen, slokker buen mens gassen fortsetter å strømme i etter-gasstiden.



Strømpulsing



Konstant strøm



Vekselstrøm



Fast Pulse



EasyArc

4.5 Programskjerm





Tillater lagring og administrasjon av 240 job som kan personaliseres av operatøren.

Programmer (JOB)

Se seksjon "Hovedskjerm"

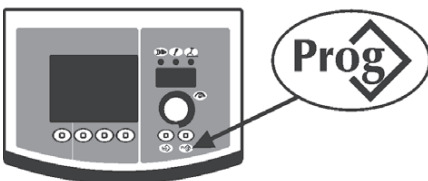
Program lagring



► "program lagring"-menyen ved å trykke knapp  i minst ett sekund.

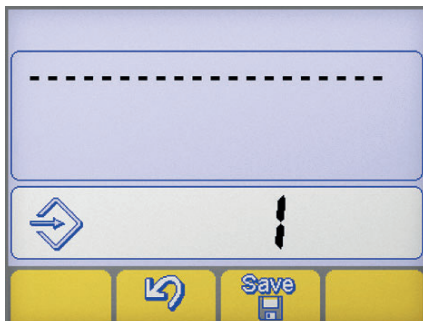

► Velg ønsket program (eller det tomme minne) ved dreieing av encoderen.

--- Minne tomt

 **Program lagret**

► Bekreft operasjonen ved å trykke knappen .

► Lagre alle aktuelle settinger for det valgte program ved å trykke knappen .

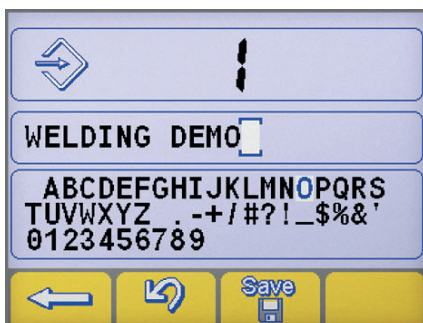

Gi en beskrivelse av programmet.

► Velg ønsket bokstav ved å dreie encoderen.

► Lagre valgt bokstav ved å trykke encoderen.

► Kanseller den siste bokstav ved å trykke knapp .

► Bekreft operasjonen ved å trykke knappen .

► Bekreft operasjonen ved å trykke knappen .



Lagring av et nytt program på et allerede okkupert minneområde, krever sletting av minneområdet med en obligatorisk prosedyre.



- ▶ Bekreft operasjonen ved å trykke knappen
- ▶ Fjern det valgte program med å trykke knapp.
- ▶ Gjenta lagringsprosedyren.

Program henting

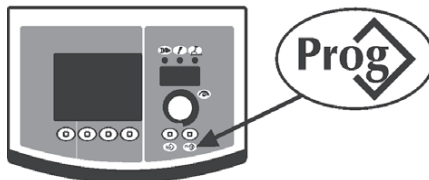

- ▶ Hent frem første program tilgjengelig ved å trykke knapp
- ▶ Velg ønsket program ved å dreie encodere.
- ▶ Velg ønsket program ved å trykke knapp.
- Bare minneområder som er okkupert av et program blir hentet frem, mens de ledige områder automatisk blir droppet.

Program kansellering



- ▶ Velg ønsket program ved å dreie encodere.
- ▶ Fjern det valgte program med å trykke knapp.
- ▶ Bekreft operasjonen ved å trykke knappen



- ▶ Bekreft operasjonen ved å trykke knappen
- ▶ Fjern det valgte program med å trykke knapp.

5. INNSTILLING

5.1 Oppsett og innstillinger av parametrene

Muliggjør innstilling og regulering av en serie ekstre parametre for en bedre og mer eksakt håndtering av sveiseanlegget. Parametrene som er inkludert i innstillingen er organisert i samsvar med den sveiseprosessen du har valgt og har et kodenummer.

For å utføre innstillingsprosedyren





- ▶ Utføres ved å trykke på encoder-knappen i 5 sekunder.
- ▶ Tilgangen bekreftes av teksten 0 på displayet.

Valg og regulering av ønsket parameter

- ▶ Skjer ved å dreie kodeenheten til den viser kodennummeret som gjelder ønsket parameter.
- ▶ Hvis du trykker på enkodertasten, kan du få vist innstilt verdi for valgt parameter og dens regulering.

For å gå ut fra innstillingsmodus

- ▶ For å gå ut fra seksjonen ”regulering”, skal du trykke på enkodertasten igjen.
- ▶ For å gå ut fra innstillingsmodus, kan du stille deg på parameter “0” (lagre og gå ut) og trykke på enkodertasten.
- ▶ Bekreft operasjonen ved å trykke knappen .
- ▶ For å lagre endringen og gå ut av set up, trykk på: .

5.1.1 Liste med parametere for innstilling (MMA)

0 Lagre og gå ut



For å lagre endringene og gå ut fra innstillingsmodus.

1 Reset



For å tilbakestille alle standard parametrene.

3 Hot start



Muliggjør regulering av verdien for hot start i MMA.

Tillater en oppstart som er mer eller mindre “varm” i fasene for buens aktivering, for å lette oppstart.

Basisk elektrode

Minimum	Maksimum	Standard
0/av	500%	80%

Cellulose elektrode

Minimum	Maksimum	Standard
0/av	500%	150%

CrNi elektrode

Minimum	Maksimum	Standard
0/av	500%	100%

Aluminiums elektrode

Minimum	Maksimum	Standard
0/av	500%	120%

Støpejerns elektrode

Minimum	Maksimum	Standard
0/av	500%	100%

Rutilelektrode

Minimum	Maksimum	Standard
0/av	500%	80%

7 Sveisestrøm



For regulering av sveisestrømmen.

Minimum	Maksimum	Standard
3 A	I _{max}	100 A

8 Arc force



For å regulere verdien Arc force i MMA.

Gjør at du oppnår dynamiske svar som er mer eller mindre energisk under sveisingen, for å lette sveiserens arbeid.

Økning av verdien på buen medfører reduksjon av risikoen for klebing av elektroden.

Basisk elektrode

Minimum	Maksimum	Standard
0/av	500%	30%

Cellulose elektrode

Minimum	Maksimum	Standard
0/av	500%	350%

CrNi elektrode

Minimum	Maksimum	Standard
0/av	500%	30%

Aluminiums elektrode

Minimum	Maksimum	Standard
0/av	500%	100%

Støpejerns elektrode

Minimum	Maksimum	Standard
0/av	500%	70%

Rutilelektrode

Minimum	Maksimum	Standard
0/av	500%	80%

204 Dynamic power control (DPC)



Det aktiverer valget av den ønskede V/I karakteristikk.

I=C Konstant strøm

Økning eller reduksjon av buehøyde har ingen effekt på nødvendig sveisestrøm.

Anbefalt for elektrode: Basisk, Rutil, Syre, Stål, Støpjern

1:20 Reduksjon av kontroll på stigningsforhold

Økning i buehøyde gir en reduksjon i sveisestrøm (og vice versa) i henhold til verdien lagt inn med 1 til 20 A per volt.

Anbefalt for elektrode: Cellulose, Aluminium

P=C Konstant effekt

Økning i buehøyden gir en reduksjon i sveisestrømmen (og vice versa) i henhold til loven: $V \cdot I = K$

Anbefalt for elektrode: Cellulose, Aluminium

312 Spenning for buefjerning



Gjør at du kan stille inn spenningsverdien som skal brukes for å slokke den elektriske buen.

For en bedre håndtering av de ulike funksjonsbetingelsene som oppstår.

Under punkt sveisingen for eksempel, gjør en lav buespenning at gnisten blir mindre når du flytter elektrodene fra stykket, og dette minker sprut, brenning og oksidering av stykket.



Still aldri inn en spenning for fjerning av buen som overstiger generatorens tomgangsspenning.

Basiskelektrode

Minimum	Maksimum	Standard
0/av	Vmax	57.0 V

Cellulose elektrode

Minimum	Maksimum	Standard
0/av	Vmax	70.0 V

399 Tillater visningen av skjærehastighet.



Lar deg sette sveisehastighet.

Default cm/min: referansehastighet for manuell sveising.

Syn: Sinergic verdi.

Minimum	Maksimum	Standard
2 cm/min	200 cm/min	15 cm/min

500 Innstilling av maskin



Tillater valg av det nødvendige grafiske grensesnitt.

Gir tilgang til høyere oppsettnivåer.

Konsulter seksjon "Grensesnitt personalisering (Set up 500)"

Verdi	Valgt nivå
USER	Bruker
SERV	Service
vaBW	vaBW

Verdi	Bruker grensesnitt
XE	Easy-modus
XA	Avansert-modus
XP	Profesjonell-modus

551 Lock/unlock



Tillater låsing av panelkontrollene og innsettingen av en beskyttelseskode.

Konsulter seksjon "Lock/unlock (Set up 551)".

552 Akustisk signal



For regulering av lyden på det akustiske signalet.

Minimum	Maksimum	Standard
0/av	10	10

601 Reguleringsstepp



Tillater reguleringen av et parameter med et stepp som kan bli personalisert av operatøren.

Minimum	Maksimum	Standard
1	Imax	1

602 Eksternt parameter 2



Tillater administrasjon av det eksterne parameter 2 (minimum verdi, maksimum verdi, standard verdi, parameter valgt).

705 Kalibrering kretsmotstand

Tillater kalibrering av anlegget.
 Konsulter seksjon "Kalibrering kretsmotstand (set up 705)".

751 Strømvlesing

Tillater visning av den reelle verdien av sveisestrømmen.

752 Spenningsavlesing

Tillater visning av den reelle verdien av sveisespenningen.

768 Måling varmetilførsel HI

Tillater avlesning av måleverdien for varmetilførselen ved sveising.

5.1.2 Liste over setup-parametere (TIG)
0 Lagre og gå ut

For å lagre endringene og gå ut fra innstillingsmodus.

1 Reset

For å tilbakestille alle standard parametrene.

2 Pre gass

For å stille inn og regulere gassflyten før buen blir aktivert.
 Muliggjør fylling av gass i sveisebrenneren og forberedemiljøet for sveiseprosedyren.

Minimum	Maksimum	Standard
0/av	99.9 s	0.1 s

3 Startstrøm

Tillater regulering av sveisestartstrømmen.
 Tillater at en varmere eller kaldere sveisepøl oppnås med det samme buen tenner.

Minimum	Maksimum	Standard	Minimum	Maksimum	Standard
1%	200%	50%	3 A	I _{max}	-

5 Startstrøm tid

Tillater setting av tiden, hvorfra initiell strøm vedlikeholdes.

Minimum	Maksimum	Standard
0/av	99.9 s	0/av

6 Oppgangsrampe

For å stille inn en gradvis overgang mellom startstrømmen og sveisestrømmen.

Minimum	Maksimum	Standard
0/av	99.9 s	0/av

7 Sveisestrøm

For regulering av sveisestrømmen.

Minimum	Maksimum	Standard
3 A	I _{max}	100 A

8 Binivå-strøm



For regulering av sekundærstrømmen i modus for binivå-sveising.

Da du trykker på sveisebrennerens trykknapp første gangen, kommer den første gassen ut, sammen med buens aktivering og sveisingen med begynnelsesstrøm.

Da du slipper knappen første gangen, øker strømmen "I1".

Hvis sveiserarbeideren trykker og siden hurtig slipper knappen, overgår enheten til "I2".

Hvis han trykker og hastig slipper knappen igjen, overgår enheten igjen til "I1" osv.

Hvis du trykker i en lengre tid, begynner senkingen av strømmen til sluttstrømmen.

Hvis du slipper trykknappen slokker buen, mens gassen fortsetter å strømme under etterperioden.

Minimum	Maksimum	Standard
3 A	I _{max}	-

Minimum	Maksimum	Standard
1%	500%	av

10 Basisstrøm



For å regulere basisstrømmen i pulset og hurtig puls modi.

Minimum	Maksimum	Standard
3 A	I _{sald}	-

Minimum	Maksimum	Standard
1%	100%	50%

12 Puls frekvens



Tillater regulering av pulsfrekvensen.

Muliggjør å oppnå bedre resultater ved sveising av tynne materialer og bedre estetisk kvalitet av sveisesømmen.

Minimum	Maksimum	Standard
0.1 Hz	25 Hz	5 Hz

13 Pulset arbeidssyklus



Tillater regulering av arbeidssyklus i pulssveising.

Tillater peak-strømmen å bli bibeholdt for en kortere eller lengere tid.

Minimum	Maksimum	Standard
1 %	99 %	50 %

14 Hurtig pulsfrekvens



Tillater regulering av pulsfrekvensen.

Muliggjør å oppnå fokusering og bedre stabilitet av den elektriske bue.

Minimum	Maksimum	Standard
0.02 KHz	2.5 KHz	0.25 KHz

15 Pulset helling



Tillater setting av stigetid under pulsoperasjonen.

Tillater å oppnå en myk overgang mellom peak-strøm og basisstrøm, og får en mer eller mindre myk sveisebue.

Minimum	Maksimum	Standard
0/av	100 %	0/av

16 Nedgangsrampe



For å stille inn en gradvis overgang mellom sveisestrømmen og sluttstrømmen.

Minimum	Maksimum	Standard
0/av	99.9 s	0/av

17 Sluttstrøm



For regulering av sluttstrømmen.

Minimum	Maksimum	Standard
3 A	I _{max}	10 A

Minimum	Maksimum	Standard
1 %	200 %	50 %

19 Sluttstrøm tid



Gjør det mulig å sette tiden hvorfra sluttstrømmen bibeholdes.

Minimum	Maksimum	Standard
0/av	99.9 s	0/av

NO

20 Ettergass



For regulering av gassflyten ved sveisingens slutt.

Minimum	Maksimum	Standard
0/av	99.9 s	syn

203 Tig start (HF)

Tillater valg av ønsket buetenning modus.

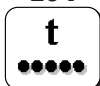
Verdi	Standard	Tilbakeringingsfunksjon
på	X	HF START
av	-	LIFT START

204 Punktsveising

Lar deg aktivere "punktsveising"-prosessen og sette opp sveisetid.

Tillater regulering av sveiseprosessen.

Minimum	Maksimum	Standard
0/av	99.9 s	0/av

205 Restart

Tillater aktivering av restart-funksjonen.

Tillater umiddelbar slukking av buen under ned-slope eller restart av sveisesyklusen.

Verdi	Standard	Tilbakeringingsfunksjon
0/av	-	av
1/on	X	på
2/of1	-	av

206 Easy joining

Tillater tenning av buen i pulset strøm og regulering av funksjonen før automatisk gjeninnsettelse av pre-satte sveisebetingelser.

Tillater større hastighet og nøyaktighet under punktsveiseoperasjoner på delene.

Minimum	Maksimum	Standard
0.1 s	25.0 s	0/av

208 Microtime spot welding

Muliggjør aktivering av "microtime spot welding".

Tillater regulering av sveiseprosessen.

Minimum	Maksimum	Standard
0.01 s	1.00 s	0/av

399 Tillater visningen av skjærehastighet.

Lar deg sette sveisehastighet.

Default cm/min: referansehastighet for manuell sveising.

Syn: Sinergic verdi.

Minimum	Maksimum	Standard
2 cm/min	200 cm/min	10 cm/min

500 Innstilling av maskin

Tillater valg av det nødvendige grafiske grensesnitt.

Gir tilgang til høyere oppsettnivåer.

Konsulter seksjon "Grensesnitt personalisering (Set up 500)"

Verdi	Valgt nivå	Verdi	Bruker grensesnitt
USER	Bruker	XE	Easy-modus
SERV	Service	XA	Avansert-modus
vaBW	vaBW	XP	Profesjonell-modus

551 Lock/unlock

Tillater låsing av panelkontrollene og innsettingen av en beskyttelseskode.

Konsulter seksjon "Lock/unlock (Set up 551)".

NO

552 Akustisk signal



For regulering av lyden på det akustiske signalet.

Minimum	Maksimum	Standard
0/av	10	10

601 Reguleringsstepp



Tillater reguleringen av et parameter med et stepp som kan bli personalisert av operatøren.

Minimum	Maksimum	Standard
1	Imax	1

602 Eksternt parameter CH1, CH2, CH3, CH4



Tillater administrasjon av det eksterne parameter 1, 2, 3, 4 (minimum verdi, maksimum verdi, standard verdi, parameter valgt).

Konsulter seksjon "Ekstern kontrolladministrasjon (Set up 602)".

606 U/D brenner



Tillater administrasjon av det eksterne parameter (U/D).

Verdi	Standard	Tilbakeringsfunksjon
0/av	-	av
1/11	X	Strøm
	-	Program henting

612 Setting sveisebrenner DgTig



Tillater å styre kanalene til den digitale sveisebrenneren.

Verdi	Standard	Tilbakeringsfunksjon
0/av	-	av
1/11	-	Strøm
2/	-	Program henting
3/CH3	-	CH3
4/CH4	-	CH4
5/STD	X	STD

705 Kalibrering kretsmotstand



Tillater kalibrering av anlegget.

Konsulter seksjon "Kalibrering kretsmotstand (set up 705)".

751 Strømavlesing



Tillater visning av den reelle verdien av sveisestrømmen.

752 Spenningsavlesing



Tillater visning av den reelle verdien av sveisespenningen.

758 Robot bevegelsehastighet



Muliggjør visning av bevegelsehastigheten på armen av en robot eller en automasjonsenhet.

764 Avlesing av kjølevæskeflyt



Tillater visning av den verdien av kjølevæskeflyt.

NO

765 Kjølevæsketemperatur lesing



Tillater visning av den reelle verdien av Kjølevæsketemperatur.

768 Måling varmetilførsel HI



Tillater avlesning av måleverdien for varmetilførselen ved sveising.

801 Vaktgrenser



Muliggjør setting av varselgrenser og av vaktgrenser.



Lar sveiseprosessen bli kontrollert ved å sette varselgrenser og vaktgrenser for de målbare hoved- parameter. Tillater nøyaktig kontroll av de forskjellige sveisefaser.

5.2 Spesifikke prosedyrer for bruk av parameterene

5.2.1 Personalisering 7-segment visning

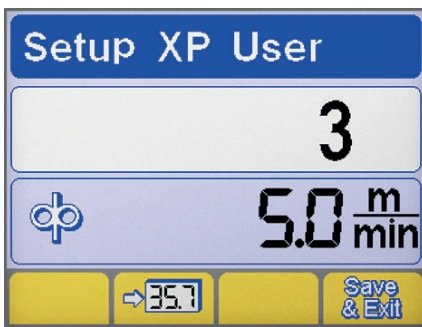
Tillater å hele tiden vise verdien til en parameter på 7-segment displayet.



- ▶ Gå inn i oppsett ved å trykke encoderknappen i minst 5 sekunder.
- ▶ Velg ønsket parameter ved å dreie encoderen.
- ▶ Lagre det valgte parameter i 7-segment visning ved å trykke knappen .
- ▶ Lagre og gå ut av nåværende skjerm ved å trykke knappen .

5.2.2 Grensesnitt personalisering (Set up 500)

Tillater parametrene å bli tilpasset på hovedmenyen.

500 Innstilling av maskin



Tillater valg av det nødvendige grafiske grensesnitt.





Verdi	Brukergrensesnitt
XE	Easy-modus
XA	Avansert-modus
XP	Profesjonell-modus







MODUS XE

MMA

Sveiseparameter 



TIG





Sveiseparameter     

Funksjoner      

MODUS XA

MMA

Sveiseparameter   

Funksjoner     

NO

TIG

Sveiseparameter								
Funksjoner								

MODUS XP

MMA

Sveiseparameter					
Funksjoner					

TIG

Sveiseparameter											
Funksjoner											

5.2.3 Lock/unlock (Set up 551)

Tillater låsing av panelkontrollene og innsettingen av en beskyttelseskode.

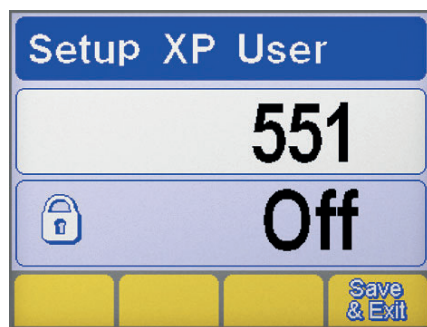

Valg av parameter

- ▶ Gå inn i oppsett ved å trykke encoderknappen i minst 5 sekunder.
- ▶ Velg det ønskete parameter (551).
- ▶ Aktiver reguleringen av det valgte parameter ved å trykke encoderknappen.

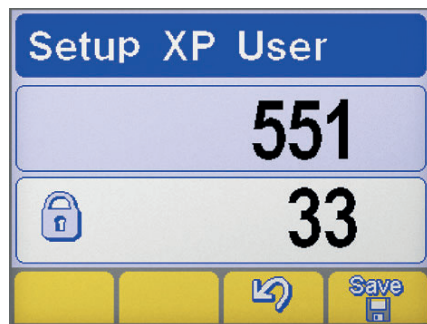

Passordinnstilling

- ▶ Sett en tallkode (passord) ved å dreie encoderen.
- ▶ Trykk på encoder-knappen for å bekrefte oppgaven.
- ▶ Bekreft operasjonen ved å trykke knappen
- ▶ For å lagre endringen, trykk på:

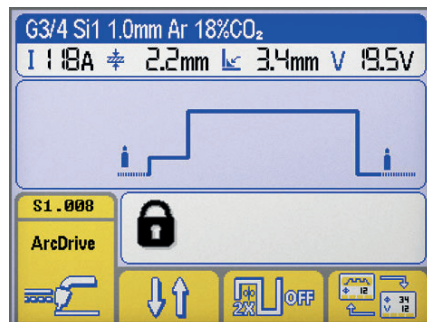

Panelfunksjoner



Utføring av enhver operasjon på et låst kontrollpanel medfører at en spesiell skjerm fremtrer.

- ▶ Gå til panelfunksjonaliteter midlertidig (5 minutter) ved å dreie encoderen og legg inn riktig passord.
- ▶ Trykk på encoder-knappen for å bekrefte oppgaven.
- ▶ Lås opp kontrollpanelet definitivt ved å gå inn i oppsett (følg instruksjonene gitt ovenfor) og bring parameter 551 tilbake til "av".
- ▶ Trykk på encoder-knappen for å bekrefte oppgaven.
- ▶ For å lagre endringen, trykk på:

NO

5.2.4 Ekstern kontrolladministrasjon (Set up 602)

Tillater administrasjon av det eksterne parameter 2 (minimum verdi, maksimum verdi, standard verdi, parameter valgt).

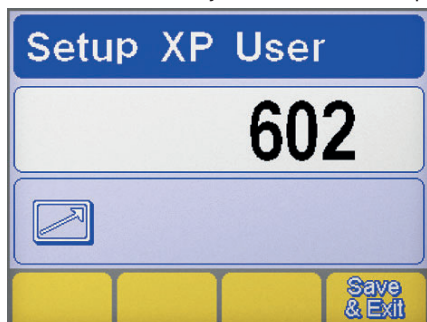

Valg av parameter

- ▶ Gå inn i oppsett ved å trykke encoderknappen i minst 5 sekunder.
- ▶ Velg det ønskete parameter (602).
- ▶ Gå inn i skjermen for "Ekstern kontrolladministrasjon" ved å trykke encoderknappen.

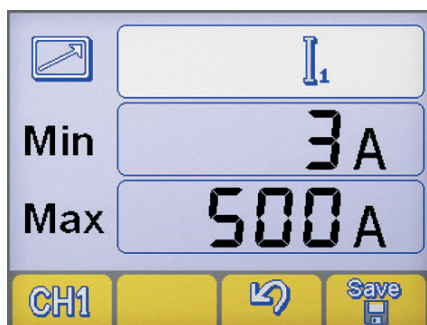

Ekstern kontrolladministrasjon

- ▶ Velg den ønskete RC fjernkontroll utgang (CH1, CH2, CH3, CH4) ved å trykke knapp. **CH1**
- ▶ Velg ønsket parameter (Min-Max-parameter) ved å trykke encoderknappen.
- ▶ Juster ønsket parameter (Min-Max-parameter) ved å dreie encodern.
- ▶ For å lagre endringen, trykk på: **Save**.
- ▶ Bekreft operasjonen ved å trykke knappen **↵**.

5.2.5 Kalibrering kretsmotstand (set up 705)

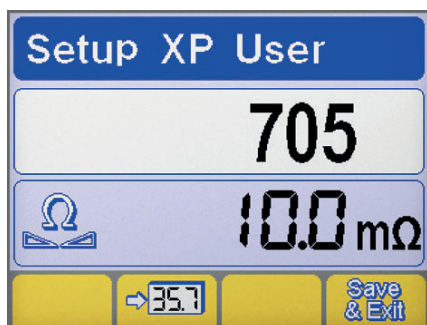

Valg av parameter

- ▶ Gå inn i oppsett ved å trykke encoderknappen i minst 5 sekunder.
- ▶ Velg det ønskete parameter (705).
- ▶ Aktiver reguleringen av det valgte parameter ved å trykke encoderknappen.

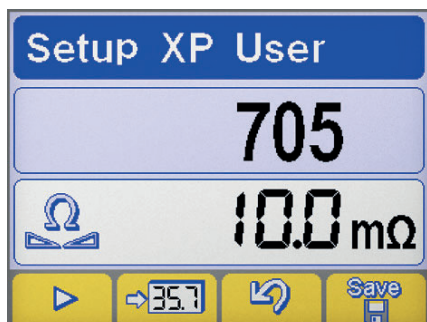

Kalibrasjon

- ▶ Plasser elektrode av tungsten i elektrisk kontakt med arbeidsstykket. (TIG)
- ▶ Plasser elektrodeholderbrenneren og stykket som skal sveises i kontakt. (MMA)
- ▶ Trykk på knappen **▶** (eller sveisebrennertast) for å starte prosedyren.
- ▶ Opprett kontakten i minst ett sekund.
- ▶ Verdien vist på displayet oppdateres ved avsluttet kalibrering.
- ▶ Bekreft operasjonen ved å trykke knappen **Save**.
- ▶ Bekreft operasjonen ved å trykke knappen **↵**.
- ▶ For å lagre endringen og gå ut av set up, trykk på: **Save & Exit**.

5.2.6 Vaktgrenser (Set up 801)

Muliggjør setting av varselgrenser og av vaktgrenser.

Lar sveiseprosessen bli kontrollert ved å sette varselgrenser og vaktgrenser for de målbare hoved- parameter.

Tillater nøyaktig kontroll av de forskjellige sveisefaser.

Konsulter seksjon "Vaktgrenser (Set up 801)".

Varselerskel		▲ MIN	▲ MAX	Vaktgrenser		▲ MIN	▲ MAX
I_i	Sveisestrøm	V	Sveisespenning	↶↷	Robot bevegelseshastighet	M₁	Strømvlesing (motor 1)
↶↷	Gassflyt lesing	↶↷	Strømvlesing (motor 2)				



Avlesing av kjølevæskeflyt



Tråd hastighet



Kjølevæsketemperatur lesing

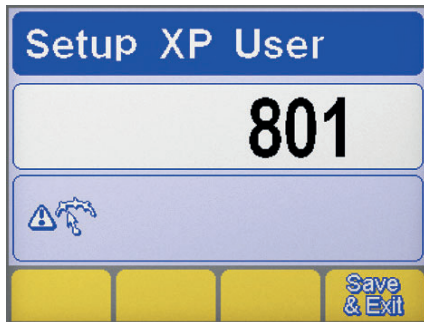

Valg av parameter

- ▶ Gå inn i oppsett ved å trykke encoderknappen i minst 5 sekunder.
- ▶ Velg det ønskete parameter (801).
- ▶ Gå inn i skjermen "Vaktgrenser" ved å trykke encoderknappen.

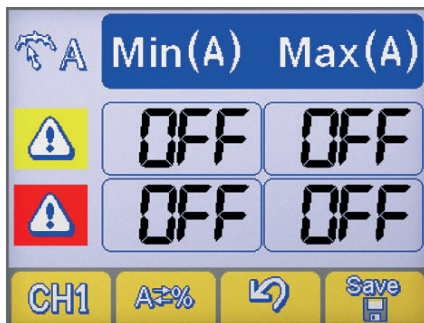

Valg av parameteren

- ▶ Velg ønsket parameter ved å trykke knappen **CH1**.
- ▶ Velg metoden for setting av vaktgrenser ved å trykke knappen **A=%**.



Innstilling av maskin



Absolutt verdi



Prosentverdi

Innstilling av sikkerhetsterskler

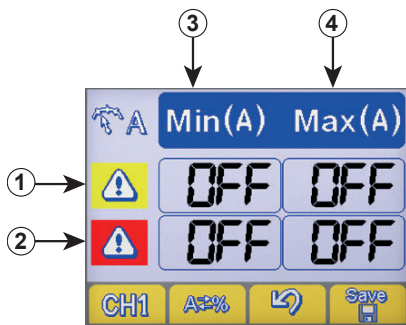

- 1 Varselgrense linje
- 2 Alarmgrense linje
- 3 Minimum nivå kolonne
- 4 Maksimum nivå kolonne

- ▶ Velg ønsket boks ved å trykke encoderknappen (den valgte boks vises med omvendt kontrast).
- ▶ Juster nivået på den valgte grense ved å dreie encoderen.
- ▶ For å lagre endringen, trykk på: **Save**.



Passering en av varselgrensene medfører at et visuelt signal fremkommer på kontrollpanelet.



Passering en av alarmgrensene medfører at et visuelt signal fremkommer på kontrollpanelet og øyeblikkelig blokkering av sveiseoperasjonene.



Det er mulig å sette start og slutt på sveise filtrene for å unngå feilsignaler under tenning og slukking av buen (konsulter seksjon "Oppsett" - Parameter 802-803-804).



6. VEDLIKEHOLD



Du må utføre rutinemessig vedlikehold på anlegget i samsvar med fabrikantens instruksjoner. Alle adgangsører, vedlikeholdsdører og deksel må være lukket og sitte godt fast når utstyret er igang. Du skal ikke utføre endringer på anlegget. Unngå at det hopper seg opp metallstøv nær eller på selve lufteribbene.



Allt vedlikeholdsarbeid må utføres kun av kvalifisert personell. Reparasjoner eller utskifting av deler på anlegget av personell som ikke er autorisert, betyr en umiddelbar annullering av produktets garanti. Eventuelle reparasjoner eller utskiftninger av anleggets deler må kun utføres av kvalifisert teknisk personell.



Kutt strømtilførselen til anlegget før ethvert inngrep!

6.1 Utfør følgende periodiske inngrep på generatoren

6.1.1 Sistem



Bruk trykkluft med lavt trykk og pensler med myk bust for rengjøring innvendig. Kontroller de elektriske kopleingene og alle koplingskablene.

6.1.2 For vedlikehold eller utskifting av brennerkomponenter, av elektrodeholderens tang og/eller jordingskablene:



Kontroller komponentenes temperatur og pass på at de ikke overopphetes.



Bruk alltid vernehansker i samsvar med forskriftene.



Bruk passende nøkler og utstyr.

6.2 Sorumluluk



Hvis det ordinære vedlikeholdsarbeidet ikke blir utført, blir garantien erklært ugyldig og fabrikanten fritas for alt ansvar. Hvis operatøren ikke følger disse instruksene, frasier fabrikanten seg alt ansvar. Ikke nøl med å ta kontakt med nærmeste tekniske assistansesenter hvis du skulle være i tvil eller det skulle oppstå problemer.

7. ALARM KODER



ALARM

























Utløsningen av en alarm eller overstigningen av en kritisk sikkerhetstærskel, fører til en visuell varsling på kontrollpanelet og en umiddelbar blokkering av sveisingen.



ADVARSEL

Overstigningen av en sikkerhetstærskel fører til en visuell varsling på kontrollpanelet, men tillater å fortsette sveisingen.

Nedenfor finnes en liste over anleggets alarmer og sikkerhetsgrenser.

 E01	Overtemperatur		 E02	Overtemperatur	
 E03	Overtemperatur		 E05	Overstrøm	
 E06	Overstrøm effektmodul (Boost)		 E07	Feil i systemet for strømtilførsel av trådtrekermotoren	
 E08	Blokkert motor		 E10	Overstrøm effektmodul (Inverter)	
 E11	Konfigurasjonsfeil av anlegget		 E13	Kommunikasjonsfeil (FP)	
 E14.xx	Ugyldig program feilens underkode angir nummeret til slettet job		 E15	Ugyldig program	

E16	Kommunikasjonsfeil (RI) (Automasjon og roboter)		E18.xx	Ugyldig program feilens underkode angir nummeret til slettet job	
E19	Konfigurasjonsfeil av anlegget		E20	Ødelagt minne	
E21	Datatap		E22	Kommunikasjonsfeil (DSP)	
E27	Ødelagt minne (RTC)		E29	Ikke kompatible mål	
E30	Kommunikasjonsfeil (H.F.)		E32	Datatap	
E33	Konfigurasjonsfeil av anlegget (LCD 3.5")		E38	Underspenning	
E39	Feil i strømførsel av anlegg		E40	Feil i strømførsel av anlegg	
E41	Overspenning		E42	Underspenning	
E43	Mangel på kjølevæske		E49	Nødstoppbryter (Automasjon og roboter)	
E51	Innstillinger ikke støttet (Automasjon og roboter)		E52	Antikollisjon (Automasjon og roboter)	
E53	Feil ekstern strømningsbryter (Automasjon og roboter)		E54	Strømnivå oversteget (Nederste grense)	
E55	Strømnivå oversteget (Øverste grense)		E56	Spenningsnivå oversteget (Nederste grense)	
E57	Spenningsnivå oversteget (Øverste grense)		E58	Strømningsnivå for gass oversteget (Nederste grense)	
E59	Strømningsnivå for gass oversteget (Øverste grense)		E62	Strømnivå oversteget (Nederste grense)	
E63	Strømnivå oversteget (Øverste grense)		E64	Spenningsnivå oversteget (Nederste grense)	
E65	Spenningsnivå oversteget (Øverste grense)		E66	Strømningsnivå for gass oversteget (Nederste grense)	
E67	Strømningsnivå for gass oversteget (Øverste grense)		E71	Overtemperatur kjølevæske	

 E72	Overstrøm push-pull motor		 E73	Hastighetsgrense tråd oversteget (speed meter)	
 E75	Strømnivå motor 2 oversteget		 E76	Strømningsnivå for kjølevæske oversteget	
 E77	Temperaturnivå kjølevæske		 E78	Aktivt vedlikehold (Automasjon og roboter)	
 E81	Overstrøm (WU-pumpe)		 E82	Kommunikasjonsfeil (WU)	
 E83	Pumpe blokkert		 E99	Generell alarm	

8. DIAGNOSTIKK OG LØSNINGER

Anlegget kan ikke startes opp (den grønne lysindikatoren tenner ikke)

Årsak

- » Ingen nettspenning i forsyningsnettet.
- » Defekt kontakt eller elektrisk strømforsyningskabel.
- » Linjens sikring er gått.
- » Defekt av/på-bryter.
- » Defekt elektronikk.

Løsning

- » Kontroller og om nødvendig reparerer det elektriske anlegget.
- » Benytt kun kvalifisert personell.
- » Skift ut den skadde komponenten.
- » Henvend deg til det nærmeste senter for teknisk assistanse for å reparere anlegget.
- » Skift ut den skadde komponenten.
- » Skift ut den skadde komponenten.
- » Henvend deg til det nærmeste senter for teknisk assistanse for å reparere anlegget.
- » Henvend deg til det nærmeste senter for teknisk assistanse for å reparere anlegget.

Ingen strøm ved utgangen (anlegget sveiser ikke)

Årsak

- » Defekt sveisebrennertast.
- » Overopphetet anlegg (termisk alarm - gul lysindikator lyser).
- » Feil jordkopling.
- » Nettspenningen er utenfor området (den gule lysindikatoren lyser).
- » Defekt kontaktor.
- » Defekt elektronikk.

Løsning

- » Skift ut den skadde komponenten.
- » Henvend deg til det nærmeste senter for teknisk assistanse for å reparere anlegget.
- » Vent til anlegget er avkjølet uten å slå fra strømmen.
- » Utfør korrekt jordkopling.
- » Se avsnittet "Installasjon".
- » Tilbakestill nettspenningen innenfor generatorens arbeidsområde.
- » Utfør enkorrekt kopling av anlegget.
- » Se avsnittet "Kopling".
- » Skift ut den skadde komponenten.
- » Henvend deg til det nærmeste senter for teknisk assistanse for å reparere anlegget.
- » Henvend deg til det nærmeste senter for teknisk assistanse for å reparere anlegget.

Feil strømforsyning

Årsak

- » Feilt valg av prosedyren for sveising eller defekt velger.
- » Feile parameterinnstillinger og funksjoner i anlegget.

Løsning

- » Utfør et korrekt valg av prosedyren sveising.
- » Utfør en reset på anlegget og tilbakestill parametrene for sveising.

- | | |
|---|---|
| <ul style="list-style-type: none"> » Defekt potensiometer/kodeenhet for regulering av strømmen for sveising. | <ul style="list-style-type: none"> » Skift ut den skadde komponenten. » Henvend deg til det nærmeste senter for teknisk assistanse for å reparere anlegget. |
| <ul style="list-style-type: none"> » Nettspenningen er utenfor området. | <ul style="list-style-type: none"> » Utfør enkorrekt kopling av anlegget. » Se avsnittet "Kopling". |
| <ul style="list-style-type: none"> » En fase mangler. | <ul style="list-style-type: none"> » Utfør enkorrekt kopling av anlegget. » Se avsnittet "Kopling". |
| <ul style="list-style-type: none"> » Defekt elektronikk. | <ul style="list-style-type: none"> » Henvend deg til det nærmeste senter for teknisk assistanse for å reparere anlegget. |

Instabilitet i buen

- | Årsak | Løsning |
|--|---|
| <ul style="list-style-type: none"> » Utilstrekkelig dekk-gass. | <ul style="list-style-type: none"> » Reguler korrekt gassflyt. » Kontroller at diffusereren og gassmunnstykket i sveisebrenneren er i god tilstand. |
| <ul style="list-style-type: none"> » Fuktighet i sveisegassen. | <ul style="list-style-type: none"> » Bruk alltid produkter eller materialer av høy kvalitet. » Forsikre deg om at gassforsyningsanlegget alltid er i god funksjonstilstand. |
| <ul style="list-style-type: none"> » Gale sveiseparameterparameter. | <ul style="list-style-type: none"> » Utfør en nøyaktig kontroll av anlegget for sveising. » Henvend deg til det nærmeste senter for teknisk assistanse for å reparere anlegget. |

Altfor mye sprut

- | Årsak | Løsning |
|--|---|
| <ul style="list-style-type: none"> » Gal buelengde. | <ul style="list-style-type: none"> » Reduser avstanden mellom elektroden og stykket. » Reduser sveisespenningen. |
| <ul style="list-style-type: none"> » Gale sveiseparameterparameter. | <ul style="list-style-type: none"> » Reduser sveisestrømmen. |
| <ul style="list-style-type: none"> » Utilstrekkelig dekk-gass. | <ul style="list-style-type: none"> » Reguler korrekt gassflyt. » Kontroller at diffusereren og gassmunnstykket i sveisebrenneren er i god tilstand. |
| <ul style="list-style-type: none"> » Gal buedynamikk. | <ul style="list-style-type: none"> » Øk kretsens induktive verdi. |
| <ul style="list-style-type: none"> » Gal modus for utførelse av sveising. | <ul style="list-style-type: none"> » Reduser sveisebrennerens vinkel. |

Utilstrekkelig hullslåing

- | Årsak | Løsning |
|--|---|
| <ul style="list-style-type: none"> » Gal modus for utførelse av sveising. | <ul style="list-style-type: none"> » Senk kjørehastigheten under sveising. |
| <ul style="list-style-type: none"> » Gale sveiseparameterparameter. | <ul style="list-style-type: none"> » Øk sveisestrømmen. |
| <ul style="list-style-type: none"> » Feil elektrode. | <ul style="list-style-type: none"> » Bruk en elektrode med mindre diameter. |
| <ul style="list-style-type: none"> » Gal forberedelse av kantene. | <ul style="list-style-type: none"> » Øk riflenes åpning. |
| <ul style="list-style-type: none"> » Feil jordkopling. | <ul style="list-style-type: none"> » Utfør korrekt jordekopling. » Se avsnittet "Installasjon". |
| <ul style="list-style-type: none"> » Stykkene som skal sveises for stor. | <ul style="list-style-type: none"> » Øk sveisestrømmen. |

Inkludering av slag

- | Årsak | Løsning |
|--|---|
| <ul style="list-style-type: none"> » Utilstrekkelig fjerning av slag. | <ul style="list-style-type: none"> » Utfør en nøyaktig rengjøring av stykkene før du utfører sveisingen. |
| <ul style="list-style-type: none"> » Elektrodens diameter er altfor stor. | <ul style="list-style-type: none"> » Bruk en elektrode med mindre diameter. |
| <ul style="list-style-type: none"> » Gal forberedelse av kantene. | <ul style="list-style-type: none"> » Øk riflenes åpning. |
| <ul style="list-style-type: none"> » Gal modus for utførelse av sveising. | <ul style="list-style-type: none"> » Reduser avstanden mellom elektroden og stykket. » La fremgangen skje regelmessig under alle fasene i sveising. |

Inkluderinger av wolfram

- | Årsak | Løsning |
|--|--|
| <ul style="list-style-type: none"> » Gale sveiseparameterparameter. | <ul style="list-style-type: none"> » Reduser sveisestrømmen. » Bruk en elektrode med en større diameter. |

» Feil elektrode.

» Bruk alltid produkter eller materialer av høy kvalitet.
» Utfør en korrekt sliping av elektroden.

» Gal modus for utførelse av sveising.

» Unngå kontakt mellom elektroden og sveisebadet.

Blåsing

Årsak

» Utilstrekkelig dekk-gass.

Løsning

» Reguler korrekt gassflyt.
» Kontroller at diffusereren og gassmunestykket i sveisebrenneren er i god tilstand.

Klebing

Årsak

» Gal buelengde.

Løsning

» Øk avstanden mellom elektroden og stykket.
» Øk sveisespenningen.

» Gale sveiseparameterparameter.

» Øk sveisestrømmen.

» Gal modus for utførelse av sveising.

» Øk sveisespenningen.

» Stykkene som skal sveises for stor.

» Still sveisebrenneren mere i vinkel.

» Gal buedynamikk.

» Øk sveisestrømmen.

» Øk sveisespenningen.

» Øk kretsens induktive verdi.

Sidekutt

Årsak

» Gale sveiseparameterparameter.

Løsning

» Reduser sveisestrømmen.
» Bruk en elektrode med mindre diameter.

» Gal buelengde.

» Reduser avstanden mellom elektroden og stykket.
» Reduser sveisespenningen.

» Gal modus for utførelse av sveising.

» Senk oscillasjonshastigheten sidestilt ved påfylling.
» Senk kjørehastigheten under sveising.

» Utilstrekkelig dekk-gass.

» Bruk gass som er egnet til materialene som skal sveises.

Oksidering

Årsak

» Utilstrekkelig dekk-gass.

Løsning

» Reguler korrekt gassflyt.
» Kontroller at diffusereren og gassmunestykket i sveisebrenneren er i god tilstand.

Porøsitet

Årsak

» Nærvær av fett, malfarge, rust eller skitt på stykkene som skal sveises.

Løsning

» Utfør en nøyaktig rengjøring av stykkene før du utfører sveisingen.

» Nærvær av fett, malfarge, rust eller skitt på materialene.

» Bruk alltid produkter eller materialer av høy kvalitet.
» Forsikre deg om at materialene alltid er i perfekt brukstilstand.

» Der er fukt i støttematerialene.

» Bruk alltid produkter eller materialer av høy kvalitet.
» Forsikre deg om at materialene alltid er i perfekt brukstilstand.

» Gal buelengde.

» Reduser avstanden mellom elektroden og stykket.
» Reduser sveisespenningen.

» Fuktighet i sveisegassen.

» Bruk alltid produkter eller materialer av høy kvalitet.
» Forsikre deg om at gassforsyningsanlegget alltid er i god funksjonstilstand.

» Utilstrekkelig dekk-gass.

» Reguler korrekt gassflyt.
» Kontroller at diffusereren og gassmunestykket i sveisebrenneren er i god tilstand.

» Altfor hurtig overgang til fast form av sveisebadet.

» Senk kjørehastigheten under sveising.
» Utfør en forvarming av stykkene som skal sveises.
» Øk sveisestrømmen.

NO

Krakelering på grunn av kulde

Årsak	Løsning
» Gale sveiseparameterparameter.	» Reduser sveisestrømmen. » Bruk en elektrode med mindre diameter.
» Nærvær av fett, malerfarge, rust eller skitt på stykkene som skal sveises.	» Utfør en nøyaktig rengjøring av stykkene før du utfører sveisingen.
» Nærvær av fett, malerfarge, rust eller skitt på materialene.	» Bruk alltid produkter eller materialer av høy kvalitet. » Forsikre deg om at materialene alltid er i perfekt brukstilstand.
» Gal modus for utførelse av sveising.	» Utfør korrekte funksjoner for den type av skjøter som skal sveises.
» Stykkene som skal sveises har ulike karakteristikk.	» Utfør smøring før du utfører sveiseprosedyren.

Krakelering på grunn av kjølighet

Årsak	Løsning
» Der er fukt i støttematerialene.	» Bruk alltid produkter eller materialer av høy kvalitet. » Forsikre deg om at materialene alltid er i perfekt brukstilstand.
» Spesiell geometri i punktet som skal sveises.	» Utfør en forvarming av stykkene som skal sveises. » Utfør en ettervarming. » Utfør korrekte funksjoner for den type av skjøter som skal sveises.

9. DRIFTSINSTRUKSJONER

9.1 Sveising med bekledd elektrode (MMA)

Forberedelse av kantene

For å oppnå gode sveiseresultater anbefales det å alltid arbeide på rene deler, fri for oksid, rust eller annet smuss.

Valg av elektrode

Diameteren på elektroden som skal benyttes er avhengig av materialets tykkelse, av posisjonen, av typen skjøt og klargjøring av stykket som skal sveises.

Elektroder med stor diameter krever høy strøm med påfølgende høy termisk tilførsel i sveisingen.

Type bekleddning	Egenskap	Bruksområde
Rutil	Enkel å bruke	Alle posisjoner
Syre	Høy smeltehastighet	Flate
Basisk	Mekaniske egenskaper	Alle posisjoner

Valg av sveisestrøm

Sveisestrømmens område for typen elektrode som benyttes angis av produsenten på elektrodeneppakkene.

Tenning og opprettholdelse av buen

Den elektriske buen oppnås ved å gni elektrodens spiss på delen som skal sveises koblet til jordingskabelen, og når buen gnister, trekkes elektroden tilbake til normal sveiseavstand.

For å forbedre tenningen av buen kan det generelt være nyttig med en økning av strømmen i begynnelsen sett i forhold til sveisestrømmen (Hot Start).

Når buen er tent begynner den midterste delen av elektroden å smelte og renner ned i form av dråper på den delen som skal sveises.

Den ytre bekleddningen av elektroden forbrukes, og dette tilfører dekkingsgass for sveisingen som således blir av ypperlig kvalitet.

For å unngå at dråpene av smeltet materialet forårsaker at buen slokner på grunn av at elektroden kortslutter og kleber ved sveisebadet, er det veldig nyttig å øke sveisestrømmen en kort stund for å smelte kortslutningen (Arc Force).

I tilfelle elektroden kleber til delen som skal sveises, anbefales det å redusere kortslutningsstrømmen til et minimum (antiklebing).

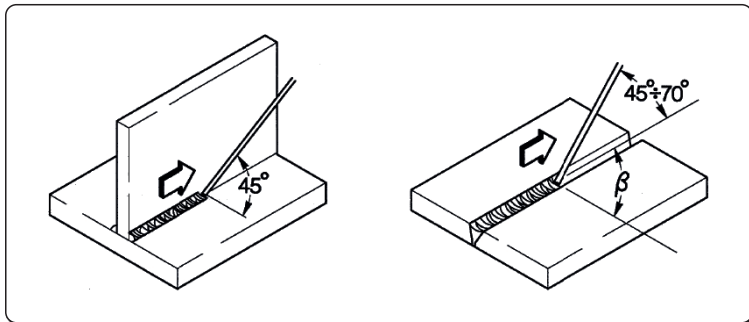

Utføring av sveising

Helningsvinkelen for elektroden varierer alt etter antallet sveisestrenger. Elektrodens bevegelse utføres normalt med oscillasjoner og med stopp på sidene av strengen slik at man unngår en opphopning av tilførselsmateriale midt på.

Fjerning av metallslag

Sveising med beklede elektroder gjør at man må fjerne metallslaget etter hver sveisestreng. Fjerningen skjer ved hjelp av en liten hammer, eller slagget børstes vekk i tilfelle det dreier seg om sprøtt metallslag.

9.2 TIG-Sveising (kontinuerlig bue)

Beskrivelse

Fremgangsmåten for TIG-sveising (Tungsten Inert Gas) er basert på prinsippet av en elektrisk bue som gnistrer mellom en usmeltelig elektrode (ren wolfram eller wolframlegering, med et smeltepunkt på cirka 3370°C) og delen: En atmosfære med inert gass (argon) gjør at badet beskyttes.

For å unngå farlige innblandinger av tungsten, skal elektroden aldri komme bort i den del som skal sveises. Derfor er sveise generatoren vanligvis utstyrt med en buetenningseenhet som genererer en høyfrekvent høyspennings utlader mellom elektrode og arbeidsstykket. Slik, takket være den elektriske gnisten, ioniseres gassatmosfæren, sveisebuen tenner uten noen kontakt mellom elektrode og arbeidsstykke.

Det finnes også en annen måte å starte på, med redusert innblanding av wolfram: Start i lift, som ikke krever høy frekvens, men en startsituasjon med kortslutning ved lav strøm mellom elektroden og delen. I det elektroden løftes, dannes buen og strømmen øker til inntastet sveiseverdi.

For å forbedre kvaliteten på sveisingens slutt del er det viktig å kontrollere nøye den synkende sveisestrømmen og det er nødvendig at gassen kommer ned i sveisebadet i noen sekunder etter at buen slukker.

I mange operative tilstander er det godt å bruke to forinnstilte sveisestrømmer slik at du lettvis kan veksle mellom de to nivåene (BINIVÅ).

Sveisepolaritet

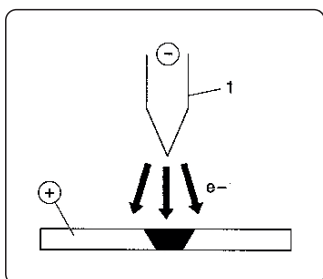

D.C.S.P. (Direct Current Straight Polarity)

Dette er den polariteten som er mest utbredt (direkte polaritet) og som gir en begrenset slitasje av elektroden (1) idet 70% av varmen konsentreres på anoden (delen).

Man oppnår trange og dype bad med høy fremføringshastighet og dermed lav termisk tilførsel.

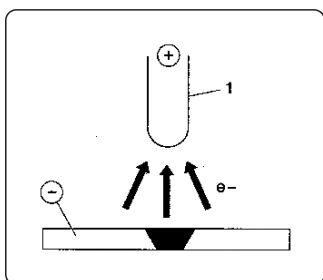

D.C.R.P. (Direct Current Reverse Polarity)

Polariteten er omvendt og gjør det mulig å sveise legeringer som er bekledd med et lag ildfast/tungtsmeltende oksid med et smeltepunkt som ligger over metalllets.

Høy strøm kan ikke benyttes da dette ville medføre stor slitasje av elektroden.

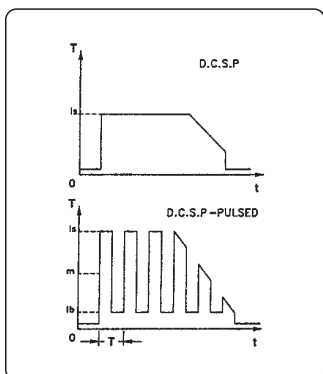

D.C.S.P.-impulser (Direct Current Straight Polarity Pulsed)

Bruk av pulset likstrøm gir en bedre kontroll, i spesielle operative situasjoner, av sveisebadets bredde og dybde.

Sveisebadet dannes av toppimpulser (Ip), mens basistrømmen (Ib) beholder buen tent. Denne operasjonsmodus hjelper ved sveising av tynnplater med mindre deformasjoner, bedre formfaktorer og medfører derfor mindre farer for overopphetning og gassgjennomslag.

Ved frekvensøkning (mellom frekvens) oppnås en smalere bue, mer konsentrert og mer stabil, og kvaliteten på sveising av tynnere materialer forbedres ytterligere.



Egenskaper for TIG-sveisinger

TIG-fremgangsmåten er veldig effektiv når det gjelder sveising av stål, det være seg karbonstål eller stållegeringer, for den første sveisestrengen på rør og i den typen sveisinger som må være særdeles vellykkede sett fra et estetisk synspunkt. Det kreves direkte polaritet (D.C.S.P.).

Forberedelse av kantene

Fremgangsmåten krever en grundig rengjøring av delene samt en nøye forberedelse

Valg og forberedelse av elektrode

Vi anbefaler deg å bruke elektroder av torium-tungsten (2% torium-rødfarget) eller alternativt elektroder som er vokset eller behandlet med følgende diameterverdier:

Strømområde			Elektrode	
(DC-)	(DC+)	(AC)	Ø	α
3-20 A	-	3-20 A	0,5 mm	30°
15-80 A	-	20-30 A	1,0 mm	30-60°
70-150 A	10-20 A	30-80 A	1,6 mm	60-90°
150-250 A	15-30 A	60-130 A	2,4 mm	90-120°
250-400 A	25-40 A	100-180 A	3,2 mm	120-150°
400-500 A	40-55 A	160-240 A	4,0 mm	150-180°
500-750 A	55-80 A	190-300 A	4,8 mm	150-180°
750-1100 A	80-125 A	325-450 A	6,4 mm	150-180°

Elektroden må spisses slik som vist på figuren.

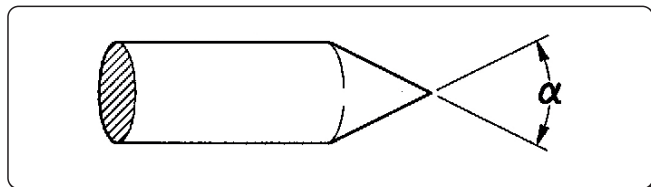

Tilførselsmateriale

Tilførselsstengene må ha mekaniske egenskaper som tilsvarer de som finnes i grunnmetallet.

Det frarådes å bruke strimler som er laget av grunnmetallet, idet de kan være urene grunnet bearbeidelsen og dermed ødelegge sveisearbeidet.

Dekkgass

I praksis brukes bestandig ren argon (99.99%).

Strømområde			Gas	
(DC-)	(DC+)	(AC)	Dyse	Strømning
3-20 A	-	3-20 A	n° 4	5-6 l/min
15-80 A	-	20-30 A	n° 5	6-8 l/min
70-150 A	10-20 A	30-80 A	n° 6	7-10 l/min
150-250 A	15-30 A	60-130 A	n° 7	8-12 l/min
250-400 A	25-40 A	100-180 A	n° 8	10-14 l/min
400-500 A	40-55 A	160-240 A	n° 8	12-16 l/min
500-750 A	55-80 A	190-300 A	n° 10	15-20 l/min
750-1100 A	80-125 A	325-450 A	n° 12	20-25 l/min

10. TEKNISK SPESIFIKASJON

Elektriske egenskaper			U.M.
Strømforsyningsspenning U1 (50/60 Hz)	3x230 (±15%)	3x400 (±15%)	Vac
Zmax (@PCC) *	53	53	mΩ
Treg linjesikring	25	16	A
Kommunikasjonsbuss	DIGITAL	DIGITAL	
Maksimal effekt absorbert	10.5	10.5	kVA
Maksimal effekt absorbert	10.1	10.1	kW
Effektforbruk i inaktiv status	51	51	W
Effektfaktor (PF)	0.96	0.96	
Yteevne (μ)	83	83	%
Cos φ	0.99	0.99	
Maksimal absorbert strøm I1max	30.8	15.3	A
Faktisk strøm I1eff	18	9	A
Reguleringsområde	3-270	3-270	A
Tomgangsspenning Uo	80	80	Vdc
Spiss-spenning Up	10.1	10.1	kV

* Dette utstyr er i overensstemmelse med EN / IEC 61000-3-11.

* Dette utstyr samsvarer med EN / IEC 61000-3-12 hvis maximum tillatt nettimpedanse ved grensesnittpunktet til offentlig nett (felles kopleingspunkt, pcc) er mindre eller lik "zmax" fastsatt verdi. Hvis det koples til et offentlig lavspenningssystem, er det installatørens eller utstyrets brukers ansvar, ved å konsultere operatøren av forsyningsnettverket om nødvendig, at utstyret kan tilkoples.

Bruksfaktor	3x230V	3x400V	U.M.
Bruksfaktor (40°C)			
(X=35%)	270	270	A
(X=60%)	230	230	A
(X=100%)	180	180	A
Bruksfaktor (25°C)			
(X=80%)	270	270	A
(X=100%)	240	240	A

Fysiske egenskaper			U.M.
Vernegrad IP	IP23S		
Isoleringsklasse	H		
Mål (lxdxh)	500x190x400		mm
Vekt	18.8		Kg
Strømkabelseksjonen	4x4		mm ²
Lengde på nettkabel	5		m
Produksjonsnormer	EN IEC 60974-1/A1:2019 EN IEC 60974-3:2019 EN 60974-10/A1:2015		

11. DATASKILT

VOESTALPINE BÖHLER WELDING SELCO S.R.L. Via Palladio, 19 - ONARA (PADOVA) - ITALY					
URANOS NX 2700 TLH		N°			
EN IEC 60974-1/A1:2019 60974-10/A1:2015 Class A	60974-3:2019				
	Up 10.1 kV				
	3A/10.0V - 270A (270A)/20.8V (20.8V)				
	X (40°C)	35%	60%	100%	
	U ₀	I ₂	270A (270A)	230A (230A)	180A (180A)
	80V	U ₂	20.8V (20.8V)	19.2V (19.2V)	17.2V (17.2V)
	3A/20.0V - 270A (270A)/30.8V (30.8V)				
	X (40°C)	35%	60%	100%	
	U ₀	I ₂	270A (270A)	230A (230A)	180A (180A)
	80V	U ₂	30.8V (30.8V)	29.2V (29.2V)	27.2V (27.2V)
50/60 Hz	U ₁ 400V(230V)	I _{1max} 15.3A(30.8A)	I _{1eff} 9A(18A)		
IP 23 S				MADE IN ITALY 	

12. BESKRIVELSE INFORMASJONSSKILT

1		2			
3		4			
5	6				
7	9	23			
		11			
8	10	12	15	16	17
		13	15A	16A	17A
		14	15B	16B	17B
7	9	11			
		12	15	16	17
8	10	13	15A	16A	17A
		14	15B	16B	17B
		18		19	20
22				MADE IN ITALY 	

- 1 Produksjonsmerke
- 2 Navn og adresse til produsenten
- 3 Apparatmodell
- 4 Serienummer
X**XX**XXXXXXXXXX Produksjonsår
- 5 Symbol for type sveisemaskin
- 6 Henvisning til konstruksjonsstandarder
- 7 Symbol for sveiseprosessen
- 8 Symbol for sveisemaskiner egnet for drift i miljøer med økt risiko for elektrisk støt
- 9 Symbol for sveisestrøm
- 10 Nominell tomgangsspenning
- 11 Område for maksimal og minimum nominell sveisestrøm og tilsvarende konvensjonell belastningsspenning
- 12 Symbol for periodisk syklus
- 13 Symbol for nominell sveisestrøm
- 14 Symbol for nominell sveisespenning
- 15 Verdier for periodisk syklus
- 16 Verdier for periodisk syklus
- 17 Verdier for periodisk syklus
- 15A Verdier for nominell sveisestrøm
- 16A Verdier for nominell sveisestrøm
- 17A Verdier for nominell sveisestrøm
- 15B Verdier for konvensjonell belastningsspenning
- 16B Verdier for konvensjonell belastningsspenning
- 17B Verdier for konvensjonell belastningsspenning
- 18 Symbol for strømforsyning
- 19 Nominell forsyningsspenning
- 20 Maksimal nominell strøm
- 21 Maksimal effektiv strøm
- 22 Beskyttelsesgrad
- 23 Nominell toppspenning

CE EU-samsvarserklæring
 EAC EAC-samsvarserklæring
 UKCA UKCA-samsvarserklæring

EU-VAATIMUSTENMUKAISUUSVAKUUTUS

Rakentaja

voestalpine Böhler Welding Selco S.r.l. - Via Palladio, 19 - 35019 Onara di Tombolo (PD) - ITALY
Tel. +39 049 9413/111 - Fax +39 049 9413/311 - www.voestalpine.com/welding

vakuuttaa omalla vastuullaan, että seuraava tuote:

URANOS NX 2700 TLH

55.07.042

55.07.043

on seuraavien EU-direktiivien mukainen:

2014/35/EU LOW VOLTAGE DIRECTIVE

2014/30/EU EMC DIRECTIVE

2011/65/EU RoHS DIRECTIVE

2019/1784/EU EcoDesign

2009/125/EU EcoDesign

ja että seuraavia yhdenmukaistettuja standardeja on sovellettu:

EN IEC 60974-1/A1:2019

WELDING POWER SOURCE

EN IEC 60974-3:2019

ARC STRIKING AND STABILIZING DEVICES

EN 60974-10/A1:2015

ELECTROMAGNETIC COMPATIBILITY REQUIREMENTS

Asiakirjat, jotka todistavat direktiivien noudattamisen, pidetään saatavilla tarkastuksia varten edellä mainitulla valmistajalla.

Jokainen korjaus tai muutos ilman voestalpine Böhler Welding Selco S.r.l.:n antamaa lupaa tekee tästä ilmoituksesta pätemättömän.

Onara di Tombolo, 01/07/2024

voestalpine Böhler Welding Selco s.r.l.



Mirco Frasson

Ivo Bonello

Managing Directors

SISÄLLYS

1. VAROITUS.....	368
1.1 Työskentelytila	368
1.2 Käyttäjän ja ulkopuolisten henkilöiden suojaaminen.....	368
1.3 Suojautuminen höyryiltä ja kaasuilta	369
1.4 Tulipalon tai räjähdysten ehkäisy.....	369
1.5 Kaasupullojen turvallinen käyttö.....	370
1.6 Suojaus sähköiskulta	370
1.7 Sähkömagneettiset kentät ja häiriöt.....	370
1.8 IP-luokitus.....	371
1.9 Loppukäsittely	372
2. ASENNUS	372
2.1 Nosto, kuljetus ja purkaus.....	372
2.2 Laitteen sijoitus.....	372
2.3 Kytkenä.....	372
2.4 Käyttöönotto	373
3. LAITTEEN ESITTELY.....	374
3.1 Takapaneeli.....	374
3.2 Liitäntäpaneeli	374
3.3 Etuohjauspaneeli.....	375
4. LAITTEIDEN KÄYTTÖ	376
4.1 Käynnistysnäyttö.....	376
4.2 Päänäyttö	376
4.3 MMA-prosessin päänäyttö	376
5. SETUP.....	380
5.1 Set up ja parametrien säätöä	380
5.2 Parametrien erityiset käyttötoimenpiteet.....	387
6. HUOLTO	391
6.1 Suorita seuraavat määräaikaist tarkastukset virtalähteelle	391
6.2 Räspundere.....	391
7. HÄLYTYSKOODIT	392
8. VIANMÄÄRITYS JA RATKAISUT.....	394
9. KÄYTTÖOHJEET	397
9.1 Puikkohitsaus (MMA).....	397
9.2 TIG-hitsaus (jatkuva kaari).....	398
10. TEKNISET OMINAISUUDET	400
11. ARVOKILPI	401
12. KILVEN SISÄLTÖ.....	401
13. KYTKENTÄKAAVIO.....	438
14. LIITTIMET.....	440
15. VARAOSALUETTELO	441

SYMBOLIT



Varoitus



Kiellot



Velvoitteet



Yleisiä viitteitä

1. VAROITUS



Ennen työskentelyä laitteella, varmista että olet lukenut ja ymmärtänyt tämän käyttöohjeen sisällön. Älä tee muutoksia tai huoltotoimenpiteitä, joita ei ole kuvattu tässä ohjeessa. Valmistajaa ei voida pitää syyllisenä henkilö- tai omaisuusvahinkoihin, jotka aiheutuvat tämän materiaalin huolimattomasta lukemisesta tai virheellisestä soveltamisesta.

Säilytä käyttöohjeet aina laitteen käyttöpaikassa. Noudata käyttöohjeiden lisäksi voimassa olevia paikallisia tapaturmantorjuntaa ja ympäristön suojelua koskevia yleisiä määräyksiä ja sääntöjä.

voestalpine Böhler Welding Selco S.r.l.:n pidättää oikeuden tehdä muutoksia ohjeeseen ilman eri ilmoitusta.

Tätä käyttöohjetta ei saa kääntää vieraalle kielelle, muuttaa tai kopioida ilman **voestalpine Böhler Welding Selco S.r.l.:**n antamaa kirjallista lupaa.

Esitetty tieto on äärimmäisen tärkeää sekä välttämätöntä takuiden soveltamiselle.

Valmistaja ei vastaa vahingoista, mikäli laitteen käyttäjä ei ole noudattanut annettuja ohjeita.



Kaikkien laitteen käyttöönottoon, käyttöön, huoltoon ja korjaukseen osallistuvien henkilöiden tulee:

- omata asianmukainen pätevyys
- omata hitsauksessa tarvittavat taidot
- lukea nämä käyttöohjeet kokonaan ja noudattaa niitä tarkasti

Käänny ammattitaitoisen henkilön puoleen epäselvissä tapauksissa sekä koneen käyttöön liittyvissä ongelmissa, myös sellaisissa tapauksissa, joihin näissä ohjeissa ei ole viitattu.

1.1 Työskentelytila



Kaikkia laitteita tulee käyttää ainoastaan siihen käyttöön, mihin ne on tarkoitettu, niiden arvokilvessä ja/tai tässä käyttöoppaassa olevien ohjeiden mukaisesti, noudattaen kansallisia ja kansainvälisiä turvallisuusdirektiivejä. Kaikki muu käyttö katsotaan sopimattomaksi ja vaaralliseksi, eikä valmistaja vastaa virheellisestä käytöstä johtuvista vahingoista.



Tämä laite on suunniteltu vain ammattimaiseen käyttöön teollisessa ympäristössä. Valmistaja ei vastaa vahingoista, jotka ovat aiheutuneet siitä, että laitetta on käytetty kotitaloudessa.



Laitetta tulee käyttää tiloissa, joiden lämpötila on -10°C ja +40°C välillä (+14°F... +104°F).

Laitetta tulee kuljettaa ja varastoida tiloissa, joiden lämpötila on -25°C ja +55°C välillä (-13°F... 131°F).

Laitetta ei saa käyttää tiloissa, joissa on pölyä, happoja, kaasuja tai muita syövyttäviä aineita.

Laitetta ei saa käyttää tiloissa, joiden suhteellinen kosteus on yli 50%, 40°C:ssa (104°F).

Laitetta ei saa käyttää tiloissa, joiden suhteellinen kosteus on yli 90%, 20°C:ssa (68°F).

Laitetta tulee käyttää korkeintaan 2000m (6500 jalkaa) merenpinnan yläpuolella.



Laitteistoa ei saa käyttää putkien sulattamiseen.

Laitetta ei saa käyttää akkujen ja/tai varaajien lataamiseen.

Laitetta ei saa käyttää moottorien käynnistämiseen.

1.2 Käyttäjän ja ulkopuolisten henkilöiden suojaaminen



Hitsausprosessissa muodostuu haitallisia säteily-, melu-, lämpö- ja kaasupurkauksia. Aseta palonkestävä väliseinä suojaamaan hitsausaluetta säteilystä, kipinöiltä ja hehkuvilta kuona-aineilta. Neuvo muita läheisyydessä olevia henkilöitä välttämään katsomasta hitsausta ja suojautumaan valokaaren säteilystä tai sulametallilta.



Pukeudu suojavaatteisiin suojataksesi ihosi säteilyltä, roiskeilta tai sulalta metallilta. Työvaatteiden tulee peittää koko keho ja niiden tulee olla:

- ehjät ja hyväkuntoiset
- palonkestävät
- eristävät ja kuivat
- kehonmyötäiset, ilman käänteitä



Käytä aina standardin mukaisia, kestäviä ja vedenpitäviä jalkineita.



Käytä aina standardin mukaisia, kuumalta ja sähkön aiheuttamilta vaaroilta suojaavia käsineitä.



Käytä silmien suojana hitsausmaskia tai muuta sopivaa suojaa (vähintään NR10 tai enemmän).



Käytä aina sivusuojilla varustettuja suojalaseja, varsinkin poistettaessa hitsauskuonaa mekaanisesti tai käsin.



Älä käytä piilolinsejä!



Käytä kuulonsuojaimia jos hitsaustapahtuma aiheuttaa melun kohoamisen haitalliselle tasolle. Jos melutaso ylittää lain asettaman ylärajan, eristä työskentelyalue ja varmista että alueelle tulevat henkilöt käyttävät kuulonsuojaimia.



Sivupaneelit on pidettävä aina suljettuina hitsaustoimenpiteiden aikana. Laitteeseen ei saa tehdä minkäänlaisia muutoksia.



Älä koske juuri hitsattuja kappaleita, kuumuus voi aiheuttaa vakavia palovammoja tai -haavoja.



Noudata edelläkuvattuja varotoimenpiteitä myös hitsauksen jälkeisissä toimenpiteissä, sillä jäähtyvistä työkappaleista saattaa irrota kuonaa.



Tarkista, että poltin on jäähtynyt ennen huolto- tai työskentelytoimenpiteiden aloittamista.



Tarkista, että jäähdytysyksikkö on sammutettu ennen kuin irrotat jäähdytysnesteen syöttö- ja takaisinvirtausletkut. Ulostuleva kuuma neste voi aiheuttaa vakavia palovammoja tai -haavoja.



Pidä ensiapupakkaus aina lähettyvillä.

Älä aliarvioi palovammojen tai muiden loukkaantumisten mahdollisuutta.



Ennen kuin poistut työpaikalta, varmista työskentelyalueen turvallisuus henkilö- ja esinevahinkojen välttämiseksi.

1.3 Suojautuminen höyryiltä ja kaasuilta



Hitsauksen muodostamat savut, kaasut ja pölyt voivat olla terveydelle haitallisia.

Hitsauksen aikana muodostuneet höyryt saattavat määrättyissä olosuhteissa aiheuttaa syöpää tai vahingoittaa sikiötä raskauden aikana.

- Pidä kasvot loitolla hitsauksessa muodostuneista kaasuista ja höyryistä.
- Järjestä kunnollinen ilmanvaihto, joko luonnollinen tai koneellinen, työskentelytilaan.
- Jos ilmanvaihto ei ole riittävä, on käytettävä kaasunsuodattimin varustettuja hengityksensuojaimia.
- Ahtaissa tiloissa hitsattaessa tulisi työtoverin valvoa hitsaustyötä ulkopuolelta.
- Älä käytä happea ilmanvaihtoon.
- Varmista ilmanvaihdon tehokkuus tarkistamalla säännöllisesti, ettei myrkyllisten kaasujen määrä ylitä turvallisuussäännöksissä esitettyä rajaa.
- Muodostuneiden höyryjen määrä ja vaarallisuus voidaan määrittellä käytettävän perusmateriaalin, lisäaineen, sekä hitsattavien kappaleiden puhdistukseen ja rasvanpoistoon mahdollisesti käytettyjen aineiden perusteella. Noudata huolellisesti valmistajan ohjeita ja vastaavia teknisiä tietoja.
- Älä hitsaa tiloissa, joissa käytetään rasvanpoisto- tai maaliaineita.
- Sijoita kaasupullot avoimiin tiloihin tai paikkaan, jossa on hyvä ilmankierto.

1.4 Tulipalon tai räjähdysen ehkäisy



Hitsausprosessi saattaa aiheuttaa tulipalon ja/tai räjähdysen.

- Tyhjennä työalue ja ympäristö kaikesta tulenarasta tai palo-herkästä materiaalista ja esineistä.
- Helposti syttyvien materiaalien tulee olla vähintään 11 metrin (35 jalkaa) etäisyydellä hitsaustilasta, tai asianmukaisesti suojattuina.
- Kipinät ja hehkuvat hiukkaset voivat helposti sinkoutua ympäristöön myös pienistä aukoista. Varmista tarkoin henkilöiden ja esineiden turvallisuus.
- Älä hitsaa paineistettujen säiliöiden päällä tai läheisyydessä.

- Älä tee hitsaustöitä säiliössä tai putkessa. Ole erittäin tarkkana hitsatessasi putkia ja säiliöitä, myös silloin, kun ne ovat avoimia, tyhjennettyjä ja hyvin puh-distettuja. Kaasun, polttoaineen, öljyn tai muiden vastaavien aineiden jäännökset voivat aiheuttaa räjähdyksiä.
- Älä hitsaa tilassa, jonka ilmapiirissä on pölyjä, kaasuja tai räjähdysalttiita höyryjä.
- Tarkista hitsaustapahtuman päätteeksi, ettei jännitteinen piiri pääse vahingossa koskettamaan maadoituspiiriin kytkettyjä osia.
- Sijoita tulensammutusmateriaali lähelle työaluetta.

1.5 Kaasupullojen turvallinen käyttö



Suojakaasupullot sisältävät paineenalaista kaasua ja voivat räjähtää huonoissa kuljetus-, säilytys- ja käyttöolosuhteissa.

- Kaasupullot tulee kiinnittää pystyasentoon seinälle tai muuhun telineeseen, jotta ne olisivat suojattuina kaatumiselta ja mekaanisilta iskuilta.
- Suojakuvun on aina oltava suljettuna kun pulloa siirretään, kun se otetaan käyttöön ja kun hitsaustoimenpiteet ovat päättyneet.
- Suojaa kaasupullot suoralta auringonsäteilyltä, äkillisiltä lämpötilanmuutoksilta, sekä erittäin korkeilta tai alhaisilta lämpötiloilta. Älä sijoita kaasupulloja erittäin korkeisiin tai alhaisiin lämpötiloihin.
- Kaasupullot eivät saa joutua kosketuksiin liekkien, sähkökaarien, polttimien tai elektrodinpitimien, eikä hitsauksen muodostamien hehkuvien säteiden kanssa.
- Pidä kaasupullot etäällä hitsauspiiristä sekä kaikista muista virtapiireistä.
- Pidä kasvoasi etäällä kaasun ulostulopisteestä kaasupullon venttiiliä avattaessa.
- Sulje venttiili aina työskentelyn päätyttyä.
- Älä koskaan hitsaa paineenalaisen kaasun säiliötä.
- Älä ikinä kytke paineilmapulloa suoraan laitteen paineenalennusventtiiliin! Paine saattaa ylittää paineenalennusventtiilin kapasiteetin ja aiheuttaa räjähdyksen!

1.6 Suojaus sähköiskulta



Sähköisku voi johtaa kuolemaan.

- Älä koske hitsausaitteen sisä- tai ulkopuolella olevia jännitteisiä osia laitteen ollessa virtalähteeseen kytkettynä (polttimet, pihdit, maadoituskaapelit, elektrodit, rullat ja kelat on kytketty sähköisesti hitsauspiiriin).
- Varmista järjestelmän ja käyttäjän sähköeristys käyttämällä kuivia tasoja ja alustoja, jotka on eristetty riittävästi maa- ja laitteen potentiaalista.
- Varmista, että laite liitetään oikein pistokkeeseen sekä verkkoon, joka on varustettu suojamaajohtimella.
- Älä koske kahta poltinta tai hitsauspuikonpidintä samanaikaisesti.
- Jos tunnet sähköiskun, keskeytä hitsaustoimenpiteet välittömästi.



Kaaren sytytys- ja vakauslaite on suunniteltu käsin tai mekaanisesti ohjattuun käyttöön.



Poltin- tai hitsauskaapeliin pituuden lisääminen yli 8 metriin lisää sähköiskun riskiä.

1.7 Sähkömagneettiset kentät ja häiriöt



Laitteen sisäisten ja ulkoisten kaapeliin läpi kulkeva virta muodostaa sähkömagneettisen kentän hitsauskaapeliin sekä itse laitteen läheisyyteen.

- Sähkömagneettiset kentät saattavat vaikuttaa sellaisten henkilöiden terveydentilaan, jotka altistuvat niille pitkäaikaisesti (vaikutusten laatua ei vielä tunneta).
- Sähkömagneettiset kentät saattavat aiheuttaa toimintahäiriöitä muihin laitteisiin, esimerkiksi sydämentahdistimeen tai kuulolaitteeseen.



Henkilöiden, joilla on sydämentahdistin, täytyy ensin keskustella lääkärin kanssa, ennen kuin voivat mennä hitsauslaitteen läheisyyteen kaarihitsauksen.

1.7.1 EMC-luokitus standardin mukaisesti: EN 60974-10/A1:2015.

- Luokan B** Luokan B laite täyttää sähkömagneettisen yhteensopivuuden vaatimukset teollisuus- ja asuin ympäristössä, mukaan lukien asuintalot, joissa sähkönjakelu tapahtuu julkisen matalajänniteverkon kautta.
- Luokan C** Luokan C laitetta ei ole tarkoitettu käytettäväksi asuintaloissa, joissa sähkönjakelu tapahtuu julkisen matalajänniteverkon kautta. Luokan A laitteiden sähkömagneettisen yhteensopivuuden saavuttaminen voi olla vaikeaa näissä olosuhteissa johtuvien ja säteilevien häiriöiden takia.

Katso lisätietoja luvusta: ARVOKILPI tai TEKNISET OMINAISUUDET.

1.7.2 Asennus, käyttö ja alueen tarkistus

Tämä laite on valmistettu yhdenmukaistettua standardia noudattaen EN 60974-10/A1:2015 ja on luokiteltu "A LUOKKAAN". Tämä laite on suunniteltu vain ammattimaiseen käyttöön teollisessa ympäristössä. Valmistaja ei vastaa vahingoista, jotka ovat aiheutuneet siitä, että laitetta on käytetty kotitaloudessa.



Laitteen käyttäjän tulee olla alan ammattilainen, joka on vastuussa laitteen asennuksesta ja sen käytöstä valmistajan ohjeita noudattaen. Jos jotain sähkömagneettista häiriötä on havaittavissa niin käyttäjän on ratkaistava ongelma, jos tarpeen yhdessä valmistajan teknisellä avulla.



Kaikissa tapauksissa sähkömagneettisia häiriöitä on vaimennettava niin paljon, etteivät ne enää aiheuta haittaa.



Ennen laitteen asennusta käyttäjän on arvioitava sähkömagneettiset ongelmat, jotka mahdollisesti voivat tulla esiin lähiympäristössä, keskittyen erityisesti henkilöiden terveydentilaan, esimerkiksi henkilöiden, joilla on sydäntahdistin tai kuulokoje.

1.7.3 Verkojännitevaatimukset

Suuritehoiset laitteet saattavat, sähköverkosta otettavan ensiövirran takia, vaikuttaa verkkojännitteen laatuun. Siksi suurinta sallittua verkkoimpedanssia (Z_{max}) tai pienintä sallittua syötön (S_{sc}) kapasitanssia koskevia liitännärajoituksia tai -vaatimuksia saattaa olla voimassa liittymässä julkiseen verkkoon (liitännänpiste, PCC) joitakin laitetyppejä koskien (ks. tekniset tiedot). Tällöin on laitteen asentajan tai käyttäjän vastuulla varmistaa, tarvittaessa yhdessä sähköyhtiön edustajan kanssa, että laitteen kytkeminen on luvallista. Häiriötapauksissa voi olla välttämätöntä ottaa käyttöön pitemmälle meneviä turvatoimia kuten suojaerotusmuuntaja.

On myös harkittava pitääkö sähkönsyöttöjohdot suojata.

Katso lisätietoja luvusta: TEKNISET OMINAISUUDET.

1.7.4 Kaapeleita koskevat varotoimet

Sähkömagneettisten kenttien vaikutuksen vähentämiseksi:

- Kelaa maadoituskaapeli ja voimakaapeli yhdessä ja kiinnitä mahdollisuuksien mukaan.
- Älä kelaa kaapeleita kehosi ympärille.
- Älä mene maadoituskaapelin ja voimakaapelin väliin (pidä molemmat samalla puolella).
- Kaapelit on pidettävä mahdollisimman lyhyinä ja lähellä toisiaan, ja niiden tulee olla maassa tai lähellä maatasoa.
- Aseta laite määrätyn välimatkan päähän hitsausalueesta.
- Kaapelit tulee sijoittaa etäälle muista mahdollisista kaapeleista.

1.7.5 Maadoitus

Hitsauslaitteiston ja sen läheisyydessä olevien metalliosien maakytkentä on varmistettava. Suojamaadoituskytkentä on tehtävä kansallisten määräysten mukaisesti.

1.7.6 Työstettävän kappaleen maadoittaminen

Mikäli työstettävää kappaletta ei ole maadoitettu sähköisten turvatoimien tai kappaleen koon tai sijainnin vuoksi, työstettävän kappaleen maadoitus saattaa vähentää sähkömagneettisia päästöjä. On tärkeää ymmärtää, että maadoitus ei saa lisätä onnettomuusriskiä eikä vahingoittaa sähköisiä laitteita. Maadoitus on tehtävä kansallisten määräysten mukaisesti.

1.7.7 Suojaus

Ympäristön muiden kaapeleiden ja laitteistojen valikoiva suojaus voi vähentää häiriöongelmia.

Koko hitsauslaitteiston suojaus voidaan ottaa huomioon erikoissovellutuksissa.

1.8 IP-luokitus

- IP** **IP23S**
- Kotelo on suojattu läpimitoiltaan 12,5 mm tai suurempien kiintoaineiden läpimurtoilta, ja vaaralliset osat on kosketussuojattu sormilta.
 - Kotelointi suojaa roiskevedeltä joka suuntautuu 60° kulmassa pystysuunnasta.
 - Kotelointi suojaa sellaisia vaurioita vastaan, jotka aiheuttaa veden sisään pääsy laitteiston liikkuvien osien ollessa liikkeessä.

1.9 Loppukäsittely



Älä hävitä sähkölaitetta tavallisten jätteiden seassa!

Sähkö- ja elektroniikkalaiteromua koskevan eurooppalaisen direktiivin 2012/19/EU ja sen täytäntöönpanevien kansallisten lakien mukaisesti sähkölaitteet tulee käyttökänsä päätyttyä erilliskerätä ja toimittaa kierrätys- ja loppukäsittelykeskukseen. Laitteen omistajan tulee tiedustella valtuutetuista jätteenkeräyskeskuksista paikallisviranomaisilta. Eurooppalaisen direktiivin soveltaminen vaikuttaa myönteisesti ympäristöön ja ihmisten terveyteen.

» Etsi lisätietoja sivustolta.

2. ASENNUS



Ainoastaan valmistajan valtuuttama henkilöstö saa suorittaa asennuksen.



Varmista asennuksen aikana, että generaattori on irti syöttöverkosta.



Virtalähteitä ei saa kytkeä toisiinsa (sarjaan tai rinnan).

2.1 Nosto, kuljetus ja purkaus

• Laitteessa on kahva, jonka avulla sitä voidaan kuljettaa kädessä.



Älä koskaan aliarvioi laitteen painoa, katso kohta Tekniset ominaisuudet.

Älä koskaan kuljeta laitetta tai jätä sitä roikkumaan niin, että sen alla on ihmisiä tai esineitä.

Älä anna laitteen kaatua äläkä pudota voimalla.

2.2 Laitteen sijoitus



Noudata seuraavia sääntöjä:

- Varmista helppo pääsy laitteen säätöihin ja liitäntöihin.
- Älä sijoita laitetta ahtaaseen paikkaan.
- Älä aseta laitetta vaakasuoralle tasolle tai tasolle, jonka kaltevuus on yli 10°.
- Kytke laitteisto kuivaan ja puhtaaseen tilaan, jossa on sopiva ilmastointi.
- Suojaa kone sateelta ja auringolta.

2.3 Kytkentä



Generaattorissa on syöttökaapeli verkkoon liitäntää varten.

Laitteen virransyöttö voi olla:

- 230V kolmivaiheinen
- 400V kolmivaiheinen

Laitteiston toiminta taataan jännitteille, jotka sijoittuvat $\pm 15\%$ nimellisarvosta.



Ihmis- ja laitevahingoilta säästymiseksi on hyvä tarkastaa valitun verkon jännite ja sulakkeet ENNEN laitteen liittämistä verkkoon. Lisäksi tulee varmistaa, että kaapeli liitetään maadoitettuun pistorasiaan.



Laitteen virransyöttö voidaan suorittaa generaattorikoneikolla, mikäli se takaa stabiilin syöttöjännitteen $\pm 15\%$ valmistajan ilmoittamaan nimellijännitteeseen nähden, kaikissa mahdollisissa toimintaolosuhteissa ja generaattorista saatavalla Maksimiteholla. Yleensä suositellaan käytettäväksi generaattorikoneikkoja, joiden teho on yksivaiheisessa 2 kertaa suurempi kuin generaattorin teho ja 1.5 kertaa suurempi kolmivaiheisessa. On suositeltavaa käyttää elektronisesti säädettyjä generaattorikoneikkoja.



Käyttäjien suojelemiseksi laite on maadoitettava kunnolla. Syöttökaapeli on varustettu johtimella (kelta-vihreä) maadoitusta varten, joka on liitettävä maadoitettuun pistorasiaan. Tätä kelta/vihreää johdinta ei saa KOSKAAN käyttää yhdessä muiden jännitejohdattimien kanssa. Varmista laitteen maadoitus ja pistokkeiden kunto. Käytä ainoastaan pistokkeita, jotka täyttävät turvallisuus-määräykset.



Sähköasennusten pitää olla ammatillisesti pätevän sähköasentajan tekemiä ja voimassa olevien määräysten mukaisia.

2.4 Käyttöotto

2.4.1 Kytkennot puikkohitsaukseen (MMA)



Liittäminen kuvan mukaan antaa tulokseksi vastanapaisuudella tapahtuvan hitsauksen. Jotta voidaan hitsata negatiivisilla navoilla, on tarpeen tehdä kytkentä käänteisesti.

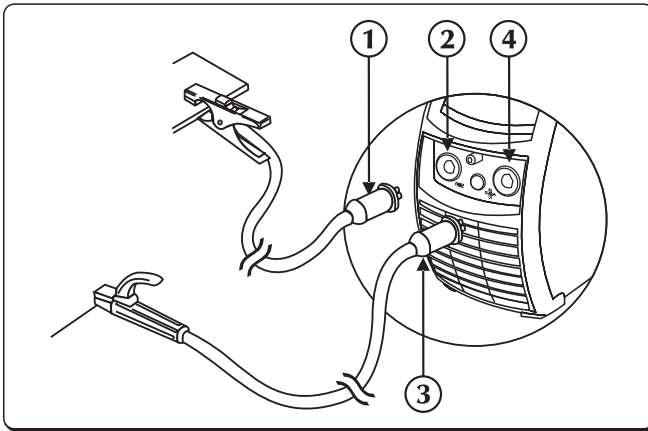



- ① Maadoitusliitin
- ② Negatiivinen liitântä (-)
- ③ Elektrodipidikkeen liitin
- ④ Positiivinen liitântä (+)

- ▶ Kiinnitä maadoituskiinnikkeen liitin virtalähteen miinusnapaan (-). Kytke pistoke ja kierrä myötäpäivään, kunnes osat ovat kokonaan kiinni.
- ▶ Kiinnitä elektrodipuikkopihdin liitin virtalähteen plusnapaan (+). Kytke pistoke ja kierrä myötäpäivään, kunnes osat ovat kokonaan kiinni.

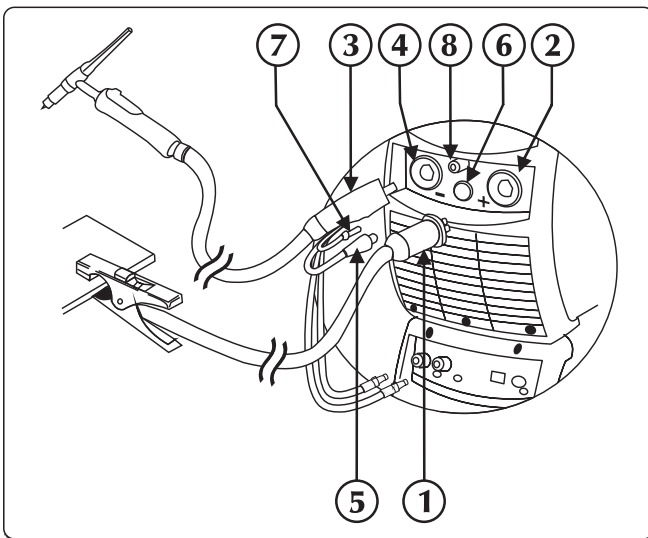
2.4.2 Kytkennot TIG-hitsaukseen



- ① Maadoitusliitin
- ② Positiivinen liitântä (+)
- ③ TIG-polttimen liitântä
- ④ Taskulamppu
- ⑤ Polttimen signaalikaapeli
- ⑥ Liittim
- ⑦ Polttimen kaasuputki
- ⑧ Kaasuliitin

- ▶ Kiinnitä maadoituskiinnikkeen liitin virtalähteen plusnapaan (+). Kytke pistoke ja kierrä myötäpäivään, kunnes osat ovat kokonaan kiinni.
- ▶ Kiinnitä TIG-polttimen liitin virtalähteen polttinliittimeen. Kytke pistoke ja kierrä myötäpäivään, kunnes osat ovat kokonaan kiinni.
- ▶ Kytke polttimen signaalikaapeli sille tarkoitettuun liittimeen.
- ▶ Kytke polttimen kaasuletku sille tarkoitettuun yhteeseen/liittimeen.
- ▶ Kiinnitä polttimen jäähdytysaineen takaisinvirtausletku (punainen) liitântään/kytkentään (punainen - symboli ).
- ▶ Kiinnitä polttimen jäähdytysaineen syöttöletku (sininen) liitântään/kytkentään (sininen - symboli .

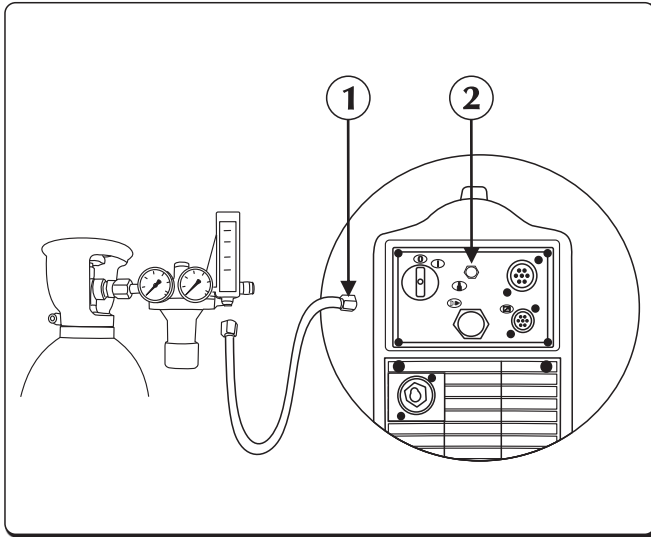

- ① Kaasuputki
- ② Kaasuliitin

► Kiinnitä kaasupullon letku takaosan kaasuliitintään. Säätelä kaasuvirtausta nostamalla se määrästä 5 l/min määrään 15 l/min.

3. LAITTEEN ESITTELY

3.1 Takapaneeli

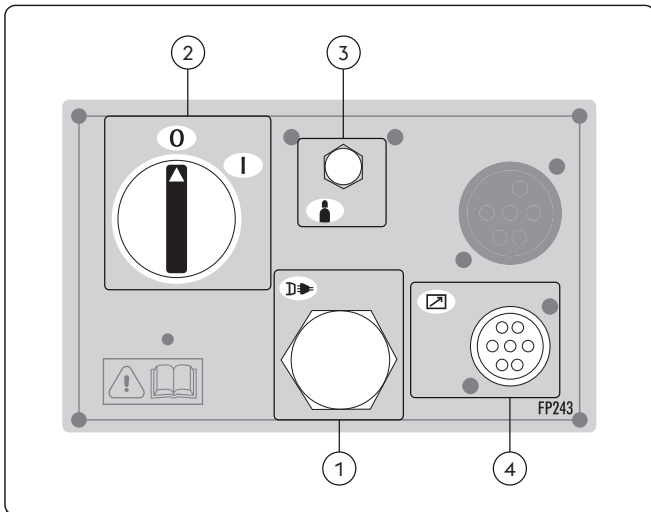

- ① Syöttökaapeli
Syöttökaapelin avulla laite liitetään sähköverkkoon virransyöttöä varten.
- ② Pääkytkin
Järjestelmän sähkösytytys.
Kytkimessä on kaksi asentoa, "O" pois kytketty ja "I" päälle kytketty.
- ③ Kaasuliitintä
- ④ Signaalikaapelin CAN-BUS tuloliitintä (RC, RI...)



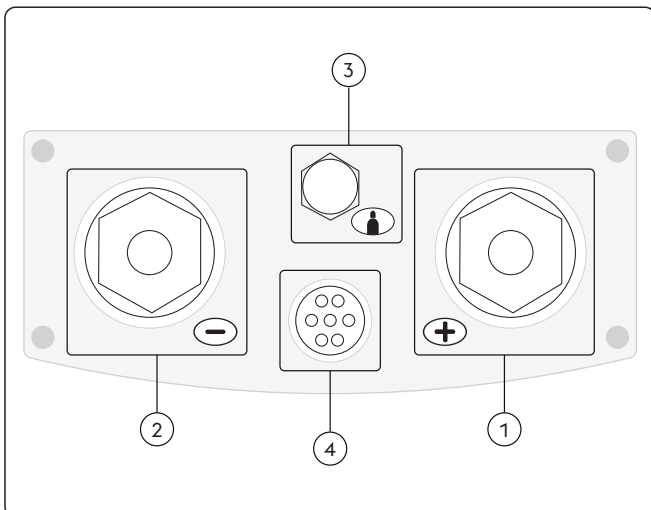



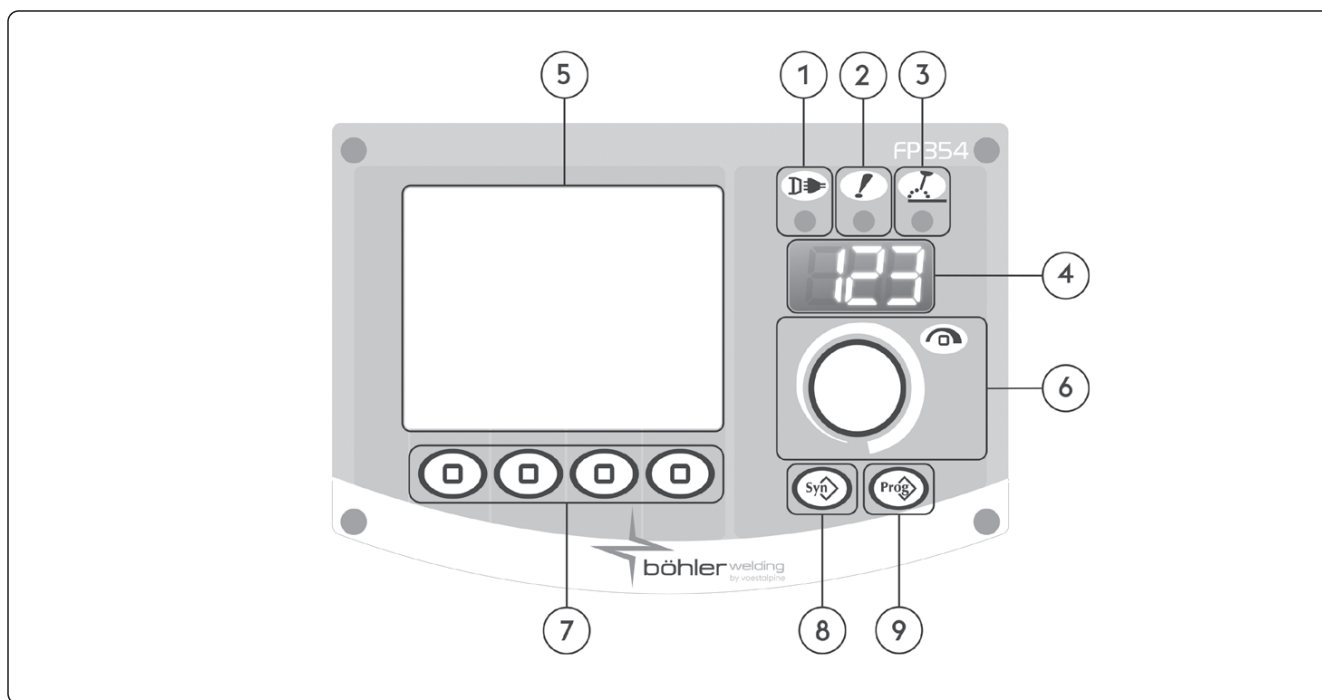

3.2 Liitintäpaneeli



- ① Positiivinen liitintä (+)
Prosessin MMA: Elektrodi-poltin liitintä
Prosessin TIG: Maadoituskaapelin liitintä
- ② Negatiivinen liitintä (-)
Prosessin MMA: Maadoituskaapelin liitintä
Prosessin TIG: Polttimen liitintä
- ③ Kaasuliitintä
- ④ Signaalikaapelin tulo (TIG-poltin)

3.3 Etuohjauspaneeli



- 1  **Virran merkkivalo**
Ilmaisee, että laite on kytketty verkkojännitteeseen ja jännite on päällä.
- 2  **Yleishälytyksen merkkivalo**
Ilmaisee mahdollisen suojalaitteiden laukeamisen, esimerkkinä lämpösuoja.
- 3  **Aktiivisen tehon merkkivalo**
Ilmaisee jännitteen olemassaolon laitteen lähtöliitännöissä.
- 4  **7-segmenttinäyttö**
Mahdollistaa hitsauskoneen parametrien näytön käynnistyksen aikana, asetusten, virta- ja jännitelukemien näytön hitsauksen aikana sekä hälytysten ilmaisun.
- 5  **LCD-näyttö**
Mahdollistaa hitsauskoneen parametrien näytön käynnistyksen aikana, asetusten, virta- ja jännitelukemien näytön hitsauksen aikana sekä hälytysten ilmaisun.
Mahdollistaa toimintojen välittömän näytön.
- 6  **Pääsäätvipu**
Mahdollistaa hitsausvirran portaattoman säädön.
Mahdollistaa pääsyn asetustilaan hitsausparametrien valintaa ja asettamista varten.
- 7  **Toimintonäppäimet**
Mahdollistaa eri järjestelmätoimintojen valinnan:
- Hitsausprosessi
- Hitsausmenetelmät
- Virran pulssitus
- Graafinen tila
- 8  **Käyttämätön näppäin**
- 9  **Työohjelman näppäin**
Mahdollistaa 240 työohjelman tallennuksen ja hallinnan. Käyttäjä voi mukauttaa ohjelmia tarpeen mukaan.

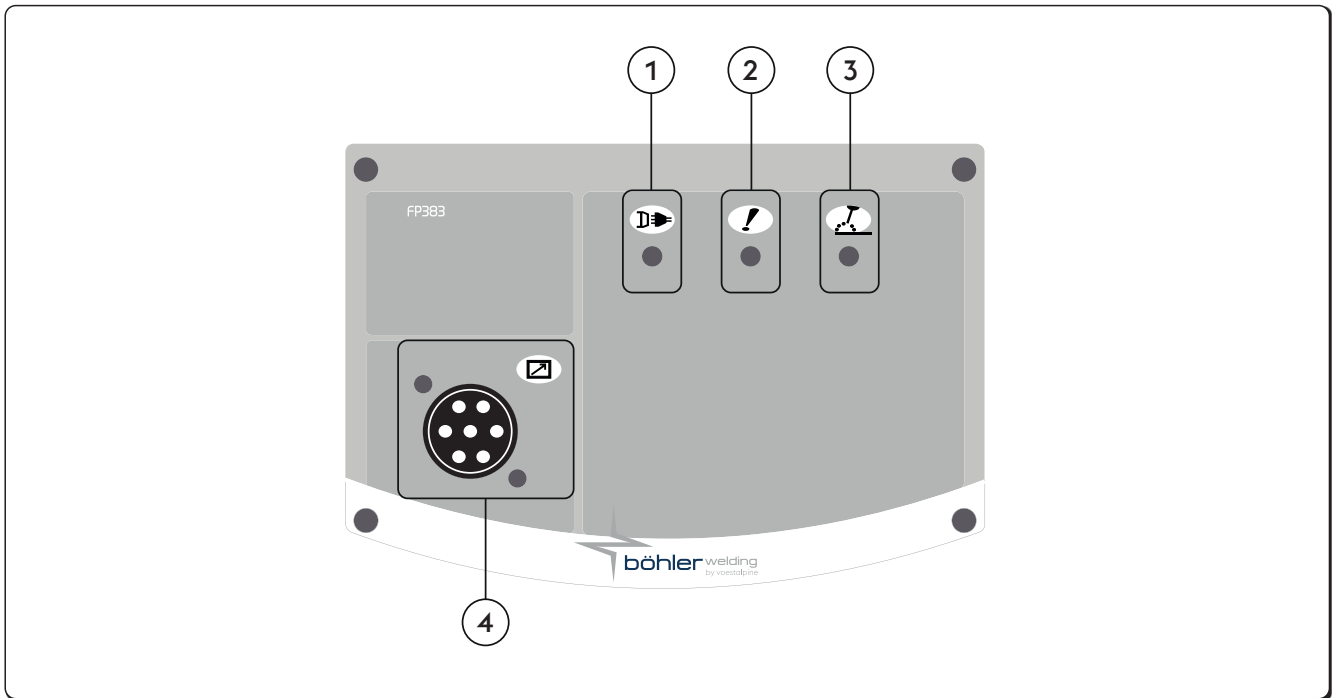

- ① **Virran merkkivalo**
Ilmaisee, että laite on kytketty verkkojännitteeseen ja jännite on päällä.
- ② **Yleishälytyksen merkkivalo**
Ilmaisee mahdollisen suojalaitteiden laukeamisen, esimerkkinä lämpösuoja.
- ③ **Aktiivisen tehon merkkivalo**
Ilmaisee jännitteen olemassaolon laitteen lähtöliitännöissä.
- ④ **Signaalikaapelin CAN-BUS tuloliitäntä (RC, RI...)**

4. LAITTEIDEN KÄYTTÖ

4.1 Käynnistysnäyttö

Kun järjestelmä käynnistetään, se suorittaa sarjan tarkistuksia, joiden tarkoituksena on taata järjestelmän ja kaikkien siihen liitettyjen laitteiden asianmukainen toiminta. Tässä vaiheessa suoritetaan myös kaasutesti kaasunsyötön oikean toiminnan tarkastamiseksi.

4.2 Päänäyttö

Mahdollistaa järjestelmän ja hitsausprosessin säädön, ja näyttää tärkeimmät asetukset.

4.3 MMA-prosessin päänäyttö

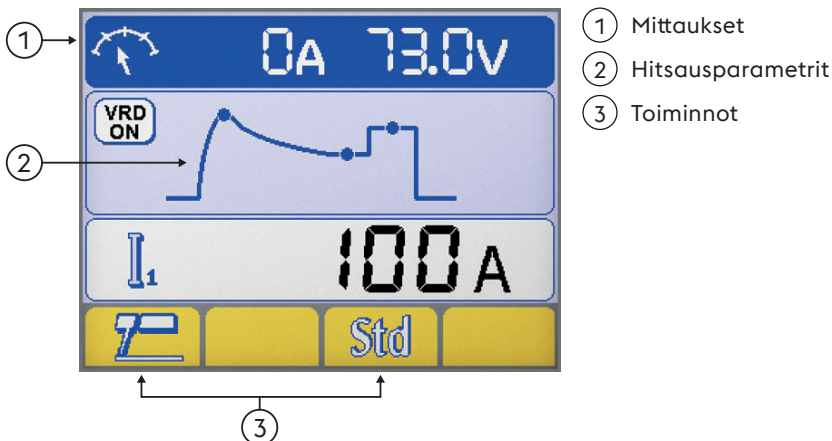

Mittaukset

Hitsauksen aikana virran ja jännitteen todelliset mittausarvot voidaan lukea LCD-näytöltä.

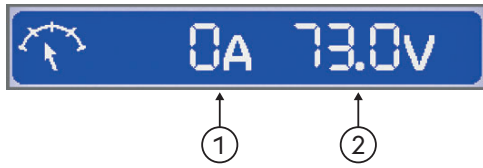

- ① Hitsausvirta
- ② Hitsausjännite

Hitsausparametrit

► Valitse haluttu parametri painamalla säätönupin painiketta.

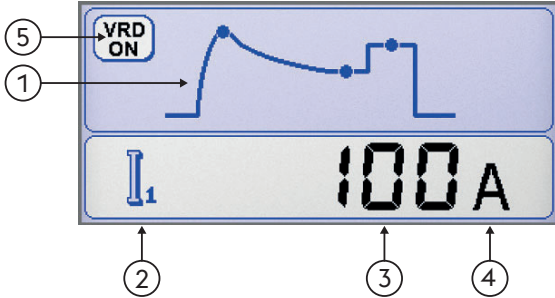

- ① Hitsausparametrit
- ② Parametrin kuvake
- ③ Parametrin arvo
- ④ Parametrin mittayksikkö
- ⑤ VRD (Voltage Reduction Device) Jännitteenalennin
Näyttää, että laitteen tyhjäkäyntijännitettä säädetään.

Toiminnot

Mahdollistaa prosessin tärkeimpien toimintojen ja hitsausmenetelmien asettamisen.

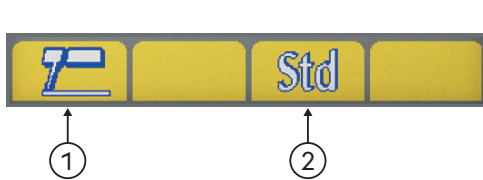

- ① Hitsausprosessi
- ② Synergia MMA



Hitsausprosessi

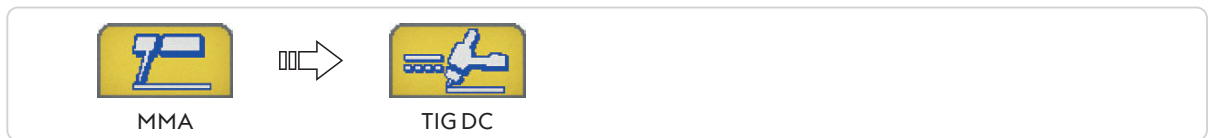

Synergia MMA

Voidaan asettaa paras valokaaren dynamiikka valitsemalla elektrodityyppi.

Kaaren oikean dynamiikan valinta mahdollistaa Maksimihyödyn saamisen laitoksen potentiaalista parhaan mahdollisen hitsaustehon saavuttamiseksi.



Täydellistä hitsattavuutta käytettävällä elektrodilla ei voida taata.

Hitsattavuus riippuu tarvikkeiden laadusta ja niiden säilytyksestä, käyttö- ja hitsausolosuhteista, useista mahdollisista käyttökohteista jne.

4.4 TIG -prosessin päänäyttö

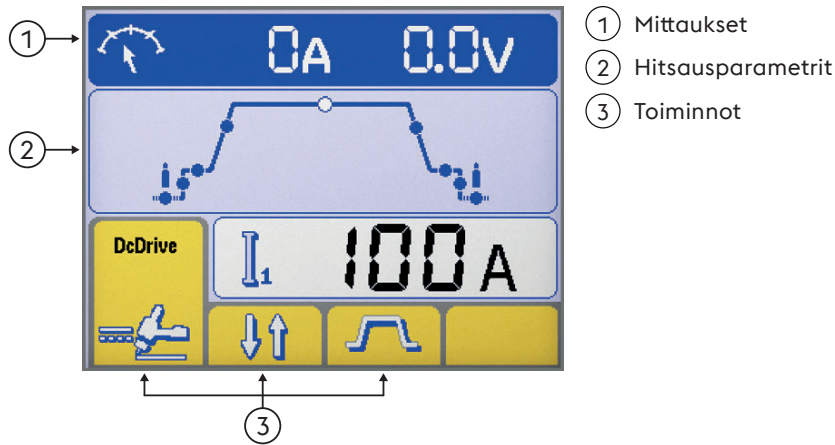

Mittaukset

Hitsauksen aikana virran ja jännitteen todelliset mittausravot voidaan lukea LCD-näytöltä.

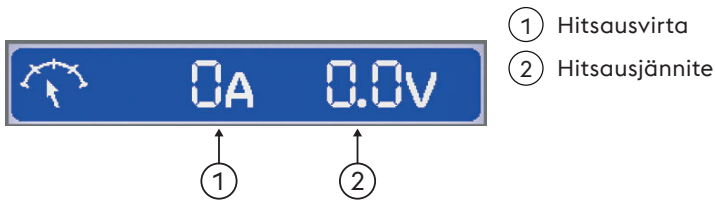

Hitsausparametrit

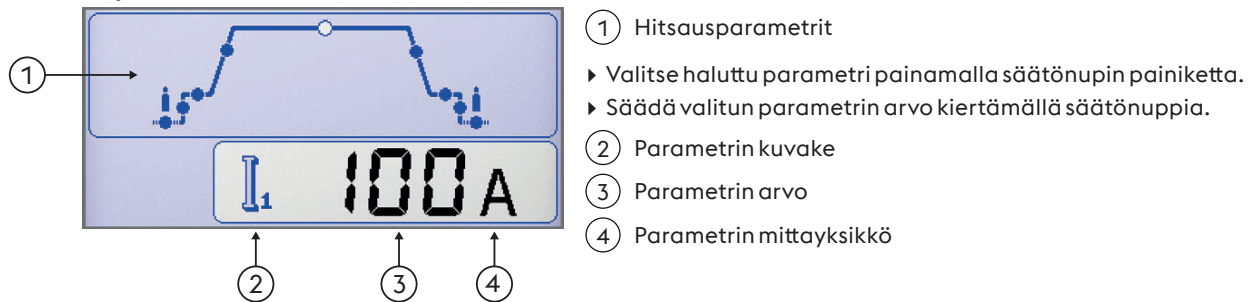

Toiminnot

Mahdollistaa prosessin tärkeimpien toimintojen ja hitsausmenetelmien asettamisen.

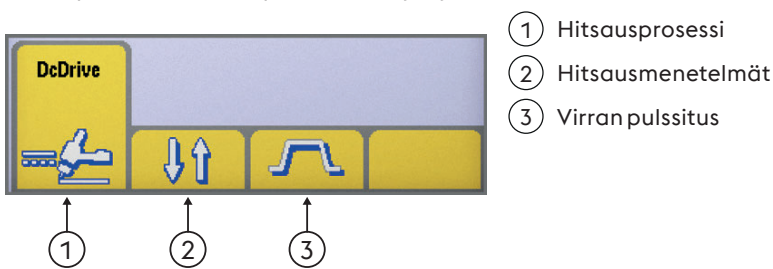

Hitsausprosessi

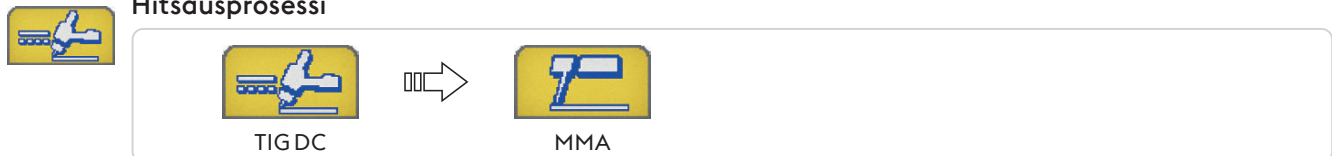

Hitsausmenetelmät

Mahdollistaa hitsausmenetelmän valinnan

2 vaihetta

2 vaiheessa painikkeen painaminen käynnistää kaasuvirtauksen ja sytyttää kaaren; vapautettaessa painike virta laskee noltaan laskurampin mukaisessa ajassa; kun kaari sammuu, kaasuvirtaus jatkuu jälkikaasuajan verran.



4 vaihetta

4 vaiheessa painikkeen ensimmäinen painallus käynnistää kaasuvirtauksen, jolloin annetaan manuaalinen esikaasu; kaari syttyy vapautettaessa painike.



Bilevel

Kaksitasotilassa hitsaaja voi käyttää hitsaukseen kahta eri virtaa, jotka on asetettu aiemmin. Painikkeen ensimmäinen painallus käynnistää esikaasuajan, kaaren sytytyksen ja hitsauksen alkuvirralla. Ensimmäinen vapautus käynnistää virran nousun "11". Jos hitsaaja painaa painiketta ja vapauttaa sen nopeasti, virraksi vaihtuu "12". Uusi nopea painallus ja vapautus palauttaa virran "11" jne. Kun liipasinta painetaan kauemmin, saadaan aikaan sen virran kasvu, joka johtaa lopulliseen virtaan. Painikkeen vapauttaminen sammuttaa kaaren, kaasuvirtaus jatkuu jälkikaasuajan verran.



Virran pulssitus



Vakiovirta



Pulssivirta



Fast Pulse



EasyArc

4.5 Ohjelmanäyttö





Mahdollistaa 240 työohjelman tallennuksen ja hallinnan. Käyttäjä voi mukauttaa ohjelmia tarpeen mukaan.

Ohjelmat (JOB)

Katso kappale "Päänäyttö"

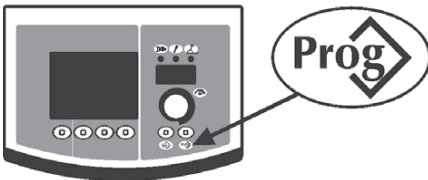
Ohjelman tallennus



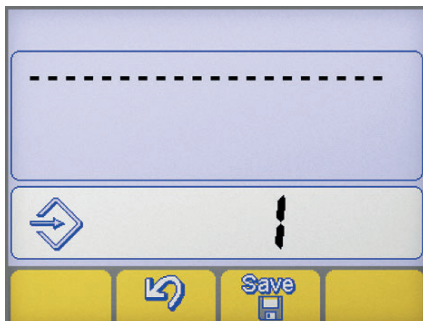

- ▶ Siirry ohjelman tallennusvalikkoon ("program storage") painamalla painiketta.  vähintään sekunnin ajan.



- ▶ Valitse haluttu ohjelma (tai tyhjä muistipaikka) kiertämällä säätönuppia.



--- Muisti tyhjä

Ohjelma tallennettu

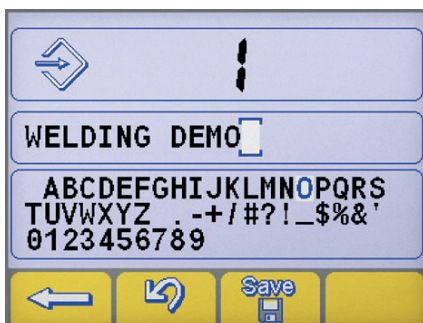
- ▶ Vahvista toiminto painamalla painiketta .
- ▶ Tallenna valitun ohjelman kaikki nykyiset asetukset painamalla painiketta. .



Syötä ohjelman kuvaus.

- ▶ Valitse haluttu kirjain säätönuppia kiertämällä.
- ▶ Tallenna haluttu kirjain säätönupin painikkeella.
- ▶ Peruuta edellinen kirjain painamalla painiketta. .
- ▶ Vahvista toiminto painamalla painiketta .
- ▶ Vahvista toiminto painamalla painiketta .



Uuden ohjelman tallentaminen jo varattuun muistipaikkaan vaatii ensin kyseisen muistipaikan poistamisen muistista.

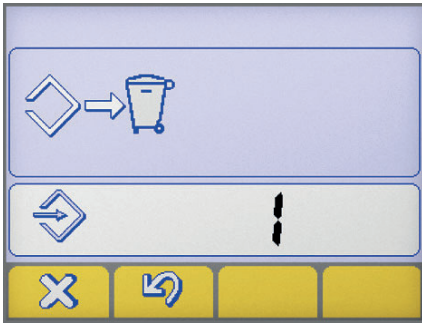

- ▶ Vahvista toiminto painamalla painiketta
- ▶ Poista valittu ohjelma painamalla painiketta.
- ▶ Jatka tallennusmenettelyä.

Ohjelman hakeminen

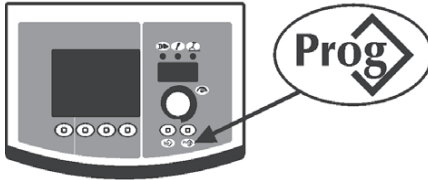

- ▶ Hae 1 olemassa oleva ohjelma painamalla painiketta
- ▶ Valitse haluttu ohjelma säätönuppia kiertämällä.
- ▶ Valitse haluttu ohjelma painamalla painiketta.

Vain muistipaikat, joissa on ohjelma, näkyvät näytöllä; tyhjät paikat ohitetaan automaattisesti.

Ohjelman peruutus



- ▶ Valitse haluttu ohjelma säätönuppia kiertämällä.
- ▶ Poista valittu ohjelma painamalla painiketta.
- ▶ Vahvista toiminto painamalla painiketta



- ▶ Vahvista toiminto painamalla painiketta
- ▶ Poista valittu ohjelma painamalla painiketta.

5. SETUP

5.1 Set up ja parametrien säätöä

Sen avulla voidaan suorittaa lisäparametrien asetus ja säätö hitsauslaitteen käytön helpottamiseksi ja tarkentamiseksi. Set up parametrit on järjestetty valitun hitsausmenetelmän mukaisesti, ja niillä on numeerinen koodi.

Set up:iin pääsy





- ▶ Paina 5 sekuntia kooderinäppäintä.
- ▶ Avaus vahvistetaan näytöllä näkyvällä 0-merkillä.

Halutun parametrin valinta ja säätö

- ▶ käännä kooderia, kunnes haluttua parametria vastaava numerokoodi tulee näkyviin.
- ▶ Kun nyt painetaan kooderi-näppäintä, saadaan näyttöön valitun parametrin asetusarvo ja säätö.

Poistuminen set up'ista

- ▶ säätö lohkoista poistutaan painamalla uudelleen kooderi-näppäintä.
- ▶ Set up'ista poistutaan siirtymällä parametrin "0" kohdalle (tallenna ja poistu) painaen kooderi-näppäintä.
- ▶ Vahvista toiminto painamalla painiketta .
- ▶ Muutos tallennetaan ja asetustilasta poistutaan painamalla näppäintä: .

5.1.1 Set up parametrin luettelo (MMA)

0 Tallenna ja poistu



Sen avulla voidaan tallentaa muutokset ja poistua set up'ista.

1 Reset



Sen avulla kaikki parametrit voidaan asettaa uudelleen Oletusihin.

3 Hot start



Kuumakäynnistyksen (Hot start) arvon säätö puikkohitsauksessa.

Sillä saadaan "kuuma" käynnistys kaaren sytytysvaiheessa, mikä helpottaa aloitustoimenpiteitä.

Emäspuikko elektrodi

Minimi	Maksimi	Oletus
0/off	500%	80%

Selluloosa elektrodi

Minimi	Maksimi	Oletus
0/off	500%	150%

CrNi-elektrodi

Minimi	Maksimi	Oletus
0/off	500%	100%

Alumiini elektrodi

Minimi	Maksimi	Oletus
0/off	500%	120%

Valurauta elektrodi

Minimi	Maksimi	Oletus
0/off	500%	100%

Rutiilelektrodi

Minimi	Maksimi	Oletus
0/off	500%	80%

7 Hitsausvirta

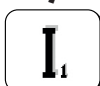

Hitsausvirran säätö.

Minimi	Maksimi	Oletus
3 A	Imax	100 A

8 Arc force



Kaaritehon (Arc force) arvon säätö puikkohitsauksessa.

Sen avulla hitsauksessa saadaan energinen dynaaminen vastus, mikä tekee hitsaamisen helpoksi.

Kaarivoiman arvon lisääminen vähentää elektrodin tarttumisriskiä.

Emäspuikko elektrodi

Minimi	Maksimi	Oletus
0/off	500%	30%

Selluloosa elektrodi

Minimi	Maksimi	Oletus
0/off	500%	350%

CrNi-elektrodi

Minimi	Maksimi	Oletus
0/off	500%	30%

Alumiini elektrodi

Minimi	Maksimi	Oletus
0/off	500%	100%

Valurauta elektrodi

Minimi	Maksimi	Oletus
0/off	500%	70%

Rutiilelektrodi

Minimi	Maksimi	Oletus
0/off	500%	80%

204 Dynamic power control (DPC)



Mahdollistaa halutun V/I-käyrän valinnan.

I=C Vakiovirta

Kaaren korkeuden lisäämisellä tai vähentämisellä ei ole vaikutusta vaadittavaan hitsausvirtaan.

Suosittelaa elektrodille: Emäspuikko, Rutiili, Haponkestävä puikko, Teräs, Valurauta

1±20 Laskevan rampin ohjaus

Kaaren korkeuden lisääminen aiheuttaa hitsausvirran pienenemisen (ja päinvastoin) annetun arvon mukaisesti välillä 1 - 20 ampeeria voltille.

Suosittelaa elektrodille: Selluloosa, Alumiini

P=C Vakioteho

Kaaren korkeuden lisääminen aiheuttaa hitsausvirran pienenemisen (ja päinvastoin) seuraavan kaavan mukaisesti: $V \cdot I = K$

Suosittelaa elektrodille: Selluloosa, Alumiini

312 Valokaaren irrotusjännite



Voidaan asettaa jännitteen arvo, jossa sähköinen valokaari sammuu.

Helpottaa toimintoja eri olosuhteissa.

Esimerkiksi pistehitsausvaiheessa, valokaaren alhaisen irrotusjännitteen ansiosta liekki sammuu vähemmän elektrodin irtaantuessa kappaleesta. Näin roiskeet, palamiset ja kappaleen hapettuminen ovat vähäisempiä.



Älä koskaan aseta generaattorin tyhjäkäyntijännitettä korkeampaa irrotusjännitettä.

Emäspuikko elektrodi

Minimi	Maksimi	Oletus
0/off	Vmax	57.0 V

Selluloosa elektrodi

Minimi	Maksimi	Oletus
0/off	Vmax	70.0 V

399 Leikkausnopeus



Mahdollistaa hitsausnopeuden asettamisen.

Default cm/min: referenssinopeus käsin hitsattaessa.

Syn: Sinergic arvo.

Minimi	Maksimi	Oletus
2 cm/min	200 cm/min	15 cm/min

500 Laitteen asetus



Mahdollistaa halutun graafisen käyttöliittymän valinnan.

Mahdollistaa pääsyn korkeammille asetustasoille.

Katso kappale "Käyttöliittymän mukauttaminen (Set up 500)"

Arvo	Valittu taso
USER	Käyttäjä
SERV	Service
vaBW	vaBW

Arvo	Käyttöliittymä
XE	Easy-toiminto
XA	Advanced-toiminto
XP	Professional-toiminto

551 Lock/unlock



Mahdollistaa paneelin säätimien lukitsemisen ja salasanan asettamisen.

Katso kappale "Lock/unlock (Set up 551)".

552 Summerin ääni



Summerin äänen säätö.

Minimi	Maksimi	Oletus
0/off	10	10

601 Säätöaskel



Mahdollistaa parametrin säädön käyttäjän haluamin säätöaskelin.

Minimi	Maksimi	Oletus
1	Imax	1

602 Ulkoinen parametri 2



Mahdollistaa ulkoisen parametrin 2 (minimiarvo, Maksimiarvo, Oletus, valittu parametri).

705
Piirin resistanssin kalibrointi

Mahdollistaa järjestelmän kalibroinnin.

Katso kappale "Piirin resistanssin kalibrointi (set up 705)".

751
Virtalukema

Mahdollistaa hitsausvirran todellisen arvon näytön.

752
Jännitelukema

Mahdollistaa hitsausjännitteen todellisen arvon näytön.

768
Lämmöntuoton arvo HI

Mahdollistaa hitsauksen lämmöntuoton mittausrvon lukemisen.

5.1.2 Asetusparametrien (TIG) luettelo
0
Tallenna ja poistu

Sen avulla voidaan tallentaa muutokset ja poistua set up'ista.

1
Reset

Sen avulla kaikki parametrit voidaan asettaa uudelleen Oletusihin.

2
Kaasun esivirtaus

Sen avulla voidaan asettaa ja säätää kaasun virtaus ennen valokaaren sytytystä.

Sen avulla voidaan ladata kaasu polttimeen ja valmistella työskentelytila hitsausta varten.

Minimi	Maksimi	Oletus
0/off	99.9 s	0.1 s

3
Alkuvirta

Mahdollistaa hitsauksen aloitusvirran säätelyn.

Mahdollistaa korkeamman tai matalamman sulalämpötilan valinnan välittömästi varokaaren syttymisen jälkeen.

Minimi	Maksimi	Oletus	Minimi	Maksimi	Oletus
1%	200%	50%	3 A	I _{max}	-

5
Alkuvirran aika



Mahdollistaa alkuvirran pitoajan asettamisen.

Minimi	Maksimi	Oletus
0/off	99.9 s	0/off

6
Slope up

Voidaan asettaa asteittainen nousu ensiövirran ja hitsausvirran välille.

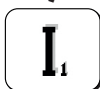
Minimi	Maksimi	Oletus
0/off	99.9 s	0/off

7
Hitsausvirta

Hitsausvirran säätö.

Minimi	Maksimi	Oletus
3 A	I _{max}	100 A

8 Kaksitasoinen virta (bilevel)



Kaksitasoisen virran säätö bilevel-hitsausmuodossa.

Polttimen liipasimen ensimmäinen painallus saa aikaan kaasun esivirtauksen, valokaaren syttymisen sekä hitsauksen ensiövirralla.

Kun liipasin vapautetaan ensimmäisen kerran, saadaan kasvu "I1" virralla.

Jos hitsaaja painaa liipasinta ja vapauttaa sen taas nopeasti, siirrytään "I2".

Painamalla ja vapauttamalla liipasinta nopeasti, siirrytään taas "I1":een, j.n.e.

Kun liipasinta painetaan kauemmin, saadaan aikaan sen virran kasvu, joka johtaa lopulliseen virtaan.

Kun liipasin vapautetaan, valokaari sammuu, kun taas kaasun virtaus jatkuu jälkivirtauksen ajan.

Minimi	Maksimi	Oletus
3 A	Imax	-

Minimi	Maksimi	Oletus
1%	500%	off

10 Kantavirta



Kantavirran säätö pulssihitsauksessa ja fast pulse toiminnossa.

Minimi	Maksimi	Oletus
3 A	Isald	-

Minimi	Maksimi	Oletus
1%	100%	50%

12 Pulssitaajuus



Mahdollistaa pulssitaajuuden säädön.

Mahdollistaa paremmat tulokset hitsattaessa ohuita materiaaleja ja esteettisesti paremman hitsipalon ulkonäön.

Minimi	Maksimi	Oletus
0.1 Hz	25 Hz	5 Hz

13 Pulssin päälläolosuhde



Mahdollistaa työjakson säädön pulssihitsauksessa.

Mahdollistaa huippuvirran ylläpitämisen lyhyen tai pitemmän ajan.

Minimi	Maksimi	Oletus
1 %	99 %	50 %

14 Fast Pulse frequency



Mahdollistaa pulssitaajuuden säädön.

Mahdollistaa sähköisen valokaaren paremman kohdistamisen ja vakauden.

Minimi	Maksimi	Oletus
0.02 KHz	2.5 KHz	0.25 KHz

15 Pulssi-slope



Mahdollistaa ramppiajan asetuksen pulssihitsauksessa.

Mahdollistaa jouhean siirtymisen huippuvirran ja perusvirran välillä, jolloin hitsauskaaren voimakkuutta voidaan säätää lähes portaattomasti.

Minimi	Maksimi	Oletus
0/off	100 %	0/off

16 Slope down



Voidaan asettaa asteittainen lasku hitsausvirran ja lopetusvirran välille.

Minimi	Maksimi	Oletus
0/off	99.9 s	0/off

17 Lopetusvirta



Lopetusvirran säätö.

Minimi	Maksimi	Oletus
3 A	Imax	10 A

Minimi	Maksimi	Oletus
1%	200%	50%

19 Lopetusvirran aika



Mahdollistaa loppuvirran pitoajan asettamisen.

Minimi	Maksimi	Oletus
0/off	99.9 s	0/off

20
Kaasunjälkivirtaus



Kaasun virtauksen säätö hitsaustapahtuman lopussa.

Minimi	Maksimi	Oletus
0/off	99.9 s	syn

203
Tig start (HF)

Mahdollistaa kaaren halutun sytytystavan valinnan.

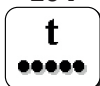
Arvo	Oletus	Soittotoiminto
päällä	X	HF START
off	-	LIFT START

204
Pistehitsaus

Mahdollistaa "pistehitsausprosessin" käytön ja hitsausajan asettamisen.

Mahdollistaa hitausprosessin ajoituksen.

Minimi	Maksimi	Oletus
0/off	99.9 s	0/off

205
Restart

Mahdollistaa uudelleenkäynnistystoiminnon aktivoimnin.

Mahdollistaa kaaren välittömän sammuttamisen ramppijakson aikana tai hitsausjakson käynnistämisen uudelleen.

Arvo	Oletus	Soittotoiminto
0/off	-	off
1/on	X	päällä
2/of1	-	off

206
Easy joining

Mahdollistaa kaaren sytyttämisen pulssimuotoisella virralla ennen ennalta määriteltyjen hitsausta koskevien ehtojen automaattista voimaantuloa.

Mahdollistaa suuremman nopeuden ja tarkkuuden osien tartuntahitsauksessa.

Minimi	Maksimi	Oletus
0.1 s	25.0 s	0/off

208
Microtime spot welding

Sen avulla voidaan käynnistää "microtime spot welding".

Mahdollistaa hitausprosessin ajoituksen.

Minimi	Maksimi	Oletus
0.01 s	1.00 s	0/off

399
Leikkausnopeus

Mahdollistaa hitsausnopeuden asettamisen.

Default cm/min: referenssinopeus käsin hitsattaessa.

Syn: Sinergic arvo.

Minimi	Maksimi	Oletus
2 cm/min	200 cm/min	10 cm/min

500
Laitteen asetus

Mahdollistaa halutun graafisen käyttöliittymän valinnan.

Mahdollistaa pääsyn korkeammille asetustasoille.

Katso kappale "Käyttöliittymän mukauttaminen (Set up 500)"

Arvo	Valittu taso	Arvo	Käyttöliittymä
USER	Käyttäjä	XE	Easy-toiminto
SERV	Service	XA	Advanced-toiminto
vaBW	vaBW	XP	Professional-toiminto

551 Lock/unlock

Mahdollistaa paneelin säätimien lukitsemisen ja salasanan asettamisen.
Katso kappale "Lock/unlock (Set up 551)".

552 Summerin ääni

Summerin äänen säätö.

Minimi	Maksimi	Oletus
0/off	10	10

601 Säätöaskel

Mahdollistaa parametrin säädön käyttäjän haluamin säätöaskelin.

Minimi	Maksimi	Oletus
1	Imax	1

602 Ulkoinen parametri CH1, CH2, CH3, CH4

Mahdollistaa ulkoisen parametrin 1, 2, 3, 4 (minimiarvo, Maksimiarvo, Oletus, valittu parametri).
Katso kappale "Ulkoisten säätimien hallinta (Set up 602)".

606 U/D torch

Mahdollistaa ulkoisen parametrin (U/D).

Arvo	Oletus	Soittotoiminto
0/off	-	off
1/11	X	Virta
	-	Ohjelman hakeminen

612 DgTig-polttimen asetus

Mahdollistaa digitaalisen polttimen kanavien hallinnan.

Arvo	Oletus	Soittotoiminto
0/off	-	off
1/11	-	Virta
2/ 	-	Ohjelman hakeminen
3/CH3	-	CH3
4/CH4	-	CH4
5/STD	X	STD

705 Piirin resistanssin kalibrointi

Mahdollistaa järjestelmän kalibroinnin.
Katso kappale "Piirin resistanssin kalibrointi (set up 705)".

751 Virtalukema

Mahdollistaa hitsausvirran todellisen arvon näytön.

752 Jännitelukema

Mahdollistaa hitsausjännitteen todellisen arvon näytön.

758 Robotin liikenopeus

Mahdollistaa robotin tai automaatiolaitteen varren liikenopeuden näytön.

764 Jäähdytysnesteen virtauslukema

Mahdollistaa jäähdytysnesteen virtauslukema.

765 Jäähdytysnesteen lämpötila lukema

Mahdollistaa jäähdytysnesteen lämpötila todellisen arvon näytön.

768 Lämmöntuoton arvo HI

Mahdollistaa hitsauksen lämmöntuoton mittausarvon lukemisen.

801 Suojarajat

Mahdollistaa varoitusrajojen ja suojarajojen asettamisen.

Mahdollistaa hitsausprosessin hallinnan asettamalla varoitusrajat ja suojarajat tärkeimmille mitattaville parametreille.



Mahdollistaa eri hitsausvaiheiden tarkan säädön.

5.2 Parametrien erityiset käyttötoimenpiteet

5.2.1 7-segmenttinäytön mukauttaminen

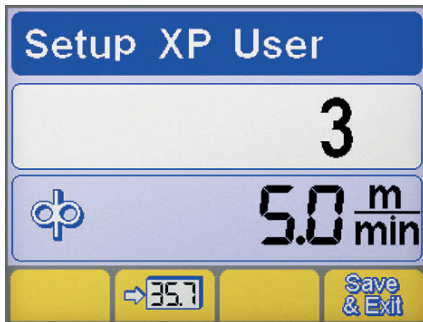
Mahdollistaa parametrin arvon jatkuvan näytön 7-segmenttinäytöllä.



- ▶ Siirry set-up-tilaan painamalla säätönupin painiketta vähintään 5 sekunnin ajan.
- ▶ Valitse tarvittava parametri kiertämällä säätönuppia.
- ▶ Tallenna valittu parametri 7-segmenttinäyttöön painamalla painiketta .
- ▶ Tallenna ja poistu nykyiseltä näytöltä painamalla painiketta .

5.2.2 Käyttöliittymän mukauttaminen (Set up 500)













Mahdollistaa parametrien mukauttamisen päävalikossa.

500 Laitteen asetus

Mahdollistaa halutun graafisen käyttöliittymän valinnan.

Arvo	Käyttöliittymä
XE	Easy-toiminto
XA	Advanced-toiminto
XP	Professional-toiminto

TOIMINTO XE

MMA	
Hitsausparametrit	
TIG	
Hitsausparametrit	    
Toiminnot	      

TOIMINTO XA

MMA	
Hitsausparametrit	
Toiminnot	
TIG	
Hitsausparametrit	
Toiminnot	

TOIMINTO XP

MMA	
Hitsausparametrit	
Toiminnot	
TIG	
Hitsausparametrit	
Toiminnot	

5.2.3 Lock/unlock (Set up 551)

Mahdollistaa paneelin säätimien lukitsemisen ja salasanan asettamisen.

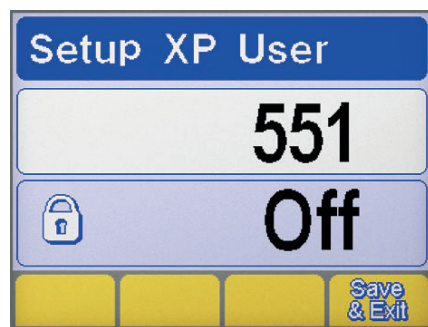

Parametrin valinta

- ▶ Siirry set-up-tilaan painamalla säätönupin painiketta vähintään 5 sekunnin ajan.
- ▶ Valitse haluttu parametri (551).
- ▶ Aktivoi valitun parametrin säätö painamalla säätönupin painiketta.

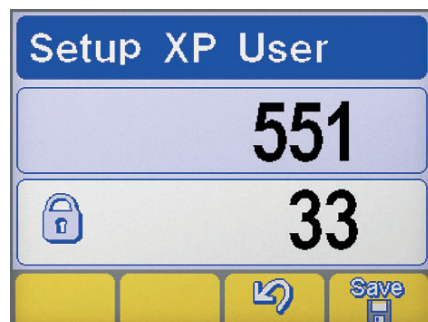

Salasanan asetus

- ▶ Aseta numerokoodi (salasana) kiertämällä säätönuppia.
- ▶ Vahvista toimenpide painamalla kooderinäppäintä.
- ▶ Vahvista toiminto painamalla painiketta .
- ▶ Tallenna muutos painamalla painiketta: .

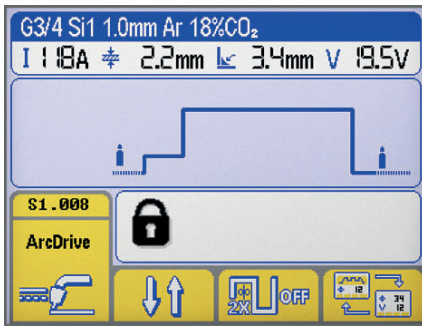

Paneelin toiminnot



Lukitun ohjauspaneelin toimintojen käyttöyritys tuo näkyviin erityisen näytön.

- ▶ Voit vapauttaa toiminnot tilapäisesti (5 minuutiksi) antamalla oikean salasanan säätönappia kiertämällä.
- ▶ Vahvista toimenpide painamalla kooderinäppäintä.
- ▶ Voit vapauttaa ohjauspaneelin kokonaan siirtymällä set-up-tilaan (seuraa edellä annettuja ohjeita) ja palauttamalla parametrin 551 arvoksi "off".
- ▶ Vahvista toimenpide painamalla kooderinäppäintä.
- ▶ Tallenna muutos painamalla painiketta: .

5.2.4 Ulkoisten säätimien hallinta (Set up 602)

Mahdollistaa ulkoisen parametrin 2 (minimi-arvo, Maksimi-arvo, Oletus, valittu parametri).

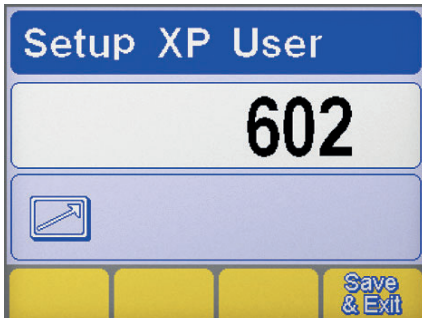

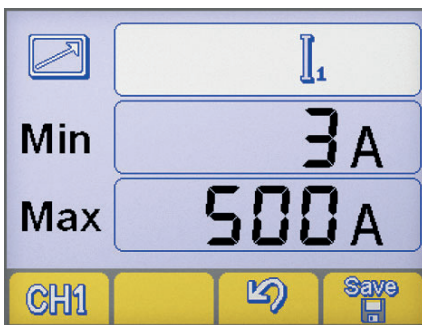

Parametrin valinta

- ▶ Siirry set-up-tilaan painamalla säätönupin painiketta vähintään 5 sekunnin ajan.
- ▶ Valitse haluttu parametri (602).
- ▶ Siirry "Ulkoisten säätimien hallinta" -näytölle painamalla säätönupin painiketta.



Ulkoisten säätimien hallinta

- ▶ Valitse haluttu RC-kauko-ohjauslähtö (CH1, CH2, CH3, CH4) painamalla painiketta: .
- ▶ Valitse haluttu parametri (Min-Max-parametri) painamalla säätönupin painiketta.
- ▶ Säädä haluttu parametri (Min-Max-parametri) kiertämällä säätönappia.
- ▶ Tallenna muutos painamalla painiketta: .
- ▶ Vahvista toiminto painamalla painiketta .

5.2.5 Piirin resistanssin kalibrointi (set up 705)

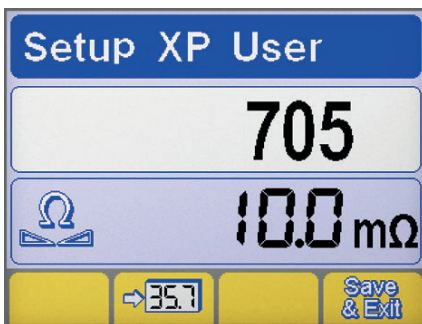



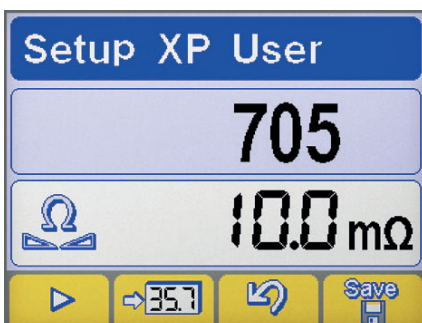

Parametrin valinta

- ▶ Siirry set-up-tilaan painamalla säätönupin painiketta vähintään 5 sekunnin ajan.
- ▶ Valitse haluttu parametri (705).
- ▶ Aktivoi valitun parametrin säätö painamalla säätönupin painiketta.



Kalibrointi

- ▶ Aseta volframelektrodi sähköiseen kosketukseen työkappaleen kanssa. (TIG)
- ▶ Aseta elektrodin pidikepoltin ja hitsattava kappale kosketuksiin. (MMA)
- ▶ Paina  (tai polttimen liipaisinta) painiketta aloittaaksesi toimenpiteen.
- ▶ Säilytä kosketus vähintään sekunnin ajan.
- ▶ Näytöllä näkyvä arvo päivitetään, kun kalibrointi on suoritettu.
- ▶ Vahvista toiminto painamalla painiketta .
- ▶ Vahvista toiminto painamalla painiketta .
- ▶ Muutos tallennetaan ja asetustilasta poistutaan painamalla näppäintä: .

5.2.6 Suojarajat (Set up 801)

Mahdollistaa varoitusrajojen ja suojarajojen asettamisen.

Mahdollistaa hitsausprosessin hallinnan asettamalla varoitusrajat ja suojarajat tärkeimmille mitattaville parametreille.

Mahdollistaa eri hitsausvaiheiden tarkan säädön.

Katso kappale "Suojarajat (Set up 801)".

Huomiotasot		▲ MIN	▲ MAX	Suojarajat		▲ MIN	▲ MAX
	Hitsausvirta		Hitsausjännite		Robotin liikenopeus		Virtalukema (moottori 1)
	Virtalukema (moottori 2)		Jäähdytysnesteen virtauslukema		Jäähdytysnesteen lämpötila lukema		

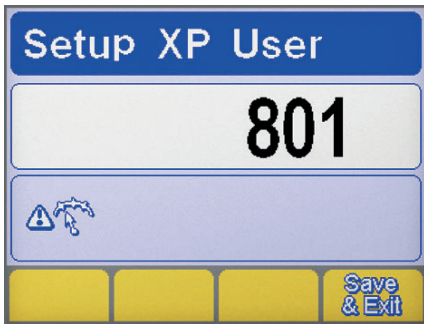

Parametrin valinta

- ▶ Siirry set-up-tilaan painamalla säätönupin painiketta vähintään 5 sekunnin ajan.
- ▶ Valitse haluttu parametri (801).
- ▶ Siirry "Suojarajat"-näytölle painamalla säätönupin painiketta.

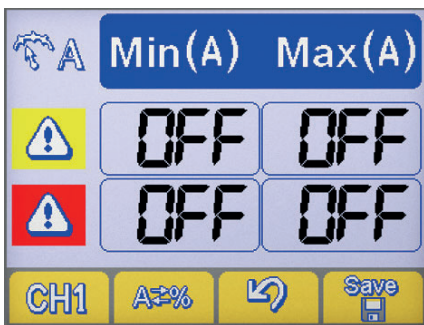

Parametrin valinta

- ▶ Valitse tarvittava parametri painamalla painiketta CH1.
- ▶ Valitse suojarajojen asetustapa painamalla painiketta A=%



Laitteen asetus



Absoluuttinen arvo



Prosenttiarvo

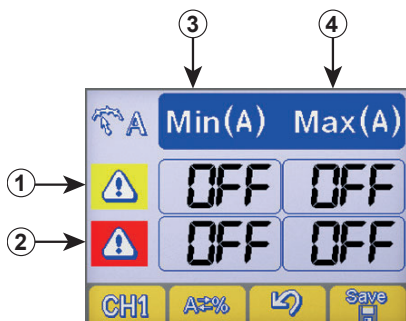

Turvallisuusrajojen asetus

- 1 Varoitusrajojen rivi
- 2 Häytysrajojen rivi
- 3 Minimiarvojen sarake
- 4 Maksimiarvojen sarake

- ▶ Valitse haluamasi ruutu painamalla säätönupin painiketta (valittu ruutu vaihtuu käänteisen väriseksi).
- ▶ Säädä valitun parametrin taso kiertämällä säätönuppia.
- ▶ Tallenna muutos painamalla painiketta: Save H.



Jonkin varoitusrajan ylittyminen aiheuttaa ohjauspaneeliin visuaalisen ilmoituksen.



Jonkin varoitusrajan ylittyminen aiheuttaa ohjauspaneeliin visuaalisen ilmoituksen ja hitsaustoiminnot keskeytyvät välittömästi.



On mahdollista asettaa hitsaussuodattimien alkua ja loppu, jotta virhesignaalit saadaan estettyä kaaren sytytyksen ja sammutuksen aikana. (katso kappale "Set up" -parametrit 802-803-804).

6. HUOLTO



Laitteessa tulee suorittaa normaalihuolto valmis- tajan antamien ohjeiden mukaisesti. Kun laite on toimiva, kaikki laitteen suojapellit ja luukut on suljettava. Laitteeseen ei saa tehdä minkäänlaisia muutoksia. Estä metallipölyä kasaantumasta lähelle tuuletusaukkoja tai niiden päälle.



Huoltotoimia voi tehdä vain niihin päteväitynyt henkilö. Takuun voimassaolo lakkaa, mikäli valtuuttamattomat henkilöt ovat suorittaneet laitteen korjaus- tai osien vaihtotoimenpiteitä. Ainoastaan ammattitaitoiset teknikot saavat suorittaa laitteen mahdolliset korjaus- tai osien vaihtotoimenpiteet.



Irrota laite sähköverkosta ennen huoltotoimenpiteitä.

6.1 Suorita seuraavat määräaikaisten tarkastukset virtalähteelle

6.1.1 Echipament



Puhdista virtalähde sisältä matalapaineisella paineilmasuihkulla ja pehmeällä harjalla. Tarkista sähköiset kytkennät ja kytkentäkaapelit.

6.1.2 Poltinkomponentin, puikon pitimen ja/tai maattokaapeleiden huoltoon tai vaihtoon:



Tarkista komponenttien lämpötila ja tarkista etteivät ne ole ylikuumentuneet.



Käytä aina turvallisuusmääräysten mukaisia suojakäsineitä.



Käytä aina sopivia ruuviavaimia ja työkaluja.

6.2 Răspundere



Ellei huoltoa suoriteta, kaikkien takuiden voimassaolo lakkaa eikä valmistaja vastaa aiheutuneista vahingoista. Valmistaja ei vastaa vahingoista, jotka ovat aiheutuneet siitä, ettei ylläolevia ohjeita ole noudatettu. Jos sinulla on epäselvyyksiä tai ongelmia, älä epäröi ottaa yhteyttä lähimpään huoltokeskukseen.

7. HÄLYTYSKOODIT



HÄLYTYS

Hälytyksen laukeamisesta tai kriittisen turvallisuusrajan ylityksestä ilmoitetaan ohjauspaneelin merkkivalolla. Se aiheuttaa hitsaustoimenpiteiden välittömän eston.



HUOMIO

Turvallisuusrajan ylityksestä ilmoitetaan ohjauspaneelin merkkivalolla. Se ei estä hitsaustoimenpiteiden jatkamista.

Seuraavassa luetellaan kaikki järjestelmää koskevat hälytykset ja turvallisuusrajat.

E01	Ylikuumeneminen		E02	Ylikuumeneminen	
E03	Ylikuumeneminen		E05	Ylivirta	
E06	Tehomodulin ylivirta (Boost)		E07	Langansyöttölaitteen moottorin sähköjärjestelmän vika	
E08	Estetty moottori		E10	Tehomodulin ylivirta (Inverter)	
E11	Järjestelmän konfigurointivirhe		E13	Yhteysvirhe (FP)	
E14.xx	Virheellinen ohjelma virheen alakoodi ilmoittaa poistetun työohjelman numeron		E15	Virheellinen ohjelma	
E16	Yhteysvirhe (RI) (Automaatio ja robotiikka)		E18.xx	Virheellinen ohjelma virheen alakoodi ilmoittaa poistetun työohjelman numeron	
E19	Järjestelmän konfigurointivirhe		E20	Muistivirhe	
E21	Datan menetys		E22	Yhteysvirhe (DSP)	
E27	Muistivirhe (RTC)		E29	Yhteensopimattomat mitat	
E30	Yhteysvirhe (H.F.)		E32	Datan menetys	
E33	Järjestelmän konfigurointivirhe (LCD 3.5")		E38	Alijännite	
E39	Laitteen sähkönsyötön vika		E40	Laitteen sähkönsyötön vika	
E41	Ylijännite		E42	Alijännite	

 E43	Jäähdytysneste puuttuu		 E49	Hätäseispainike (Automaatio ja robotiikka)	
 E51	Asetuksia ei tueta (Automaatio ja robotiikka)		 E52	Törmäyksenesto (Automaatio ja robotiikka)	
 E53	Ulkoisen virtauskytkimen virhe (Automaatio ja robotiikka)		 E54	Virtataso ylittynyt (Alaraja)	
 E55	Virtataso ylittynyt (Yläraja)		 E56	Jännitetaso ylittynyt (Alaraja)	
 E57	Jännitetaso ylittynyt (Yläraja)		 E58	Kaasun virtaustaso ylittynyt (Alaraja)	
 E59	Kaasun virtaustaso ylittynyt (Yläraja)		 E62	Virtataso ylittynyt (Alaraja)	
 E63	Virtataso ylittynyt (Yläraja)		 E64	Jännitetaso ylittynyt (Alaraja)	
 E65	Jännitetaso ylittynyt (Yläraja)		 E66	Kaasun virtaustaso ylittynyt (Alaraja)	
 E67	Kaasun virtaustaso ylittynyt (Yläraja)		 E71	Jäähdytysnesteen ylikuumentuminen	
 E72	Push-pull-moottorin ylivirta		 E73	Langan nopeusraja ylittynyt (speed meter)	
 E75	Moottorin 2 virtataso ylittynyt		 E76	Jäähdytysnesteen virtaustaso ylittynyt	
 E77	Jäähdytysnesteen lämpötilataso		 E78	Huolto käynnissä (Automaatio ja robotiikka)	
 E81	Ylivirta (WU-pumppu)		 E82	Yhteysvirhe (WU)	
 E83	Pumppu pysähtynyt		 E99	Yleishälytys	

8. VIANMÄÄRITYS JA RATKAISUT

Laite ei käynnisty (vihreä merkkivalo ei pala)

Syy

- » Ei jännitettä pistorasiassa.
- » Virheellinen pistoke tai kaapeli.
- » Linjan sulake palanut.
- » Sytytyskytkin viallinen.
- » Elektroniikka viallinen.

Toimenpide

- » Suorita tarkistus ja korjaa sähköjärjestelmä.
- » Käänny ammattitaitoisen henkilön puoleen.
- » Vaihda viallinen osa.
- » Käänny lähimmän huoltokeskuksen puoleen laitteen korjaamista varten.
- » Vaihda viallinen osa.
- » Vaihda viallinen osa.
- » Käänny lähimmän huoltokeskuksen puoleen laitteen korjaamista varten.
- » Käänny lähimmän huoltokeskuksen puoleen laitteen korjaamista varten.

Ulostulojännitteen poisjäntti (laite ei hitsaa)

Syy

- » Polttimen liipaisin virheellinen.
- » Laite on ylikuumentunut (lämpöhälytys - keltainen merkkivalo palaa).
- » Maadoituskytkentä virheellinen.
- » Verkkojännite rajojen ulkopuolella (keltainen merkkivalo palaa).
- » Kontaktori viallinen.
- » Elektroniikka viallinen.

Toimenpide

- » Vaihda viallinen osa.
- » Käänny lähimmän huoltokeskuksen puoleen laitteen korjaamista varten.
- » Odota laitteen jäähtymistä sammuttamatta sitä.
- » Suorita maadoituskytkentä oikein.
- » Katso ohjeet kappaleessa "Käyttöönotto".
- » Palauta verkkojännite generaattorin syöttörajoihin.
- » Suorita laitteen kytkentä oikein.
- » Katso ohjeet kappaleesta "KytKentä".
- » Vaihda viallinen osa.
- » Käänny lähimmän huoltokeskuksen puoleen laitteen korjaamista varten.
- » Käänny lähimmän huoltokeskuksen puoleen laitteen korjaamista varten.

Tehoulostulo virheellinen

Syy

- » Leikkausprosessin virheellinen valinta tai virheellinen valintakytkin.
- » Hitsausparametrien ja toimintojen asetus virheellinen.
- » Virransäätöpotentiometri/kooderi viallinen viallinen.
- » Verkkojännite rajojen ulkopuolella.
- » Vaiheen puuttuminen.
- » Elektroniikka viallinen.

Toimenpide

- » Valitse oikea hitsausprosessi.
- » Suorita laitteen nollaus ja aseta hitsausparametrit uudelleen.
- » Vaihda viallinen osa.
- » Käänny lähimmän huoltokeskuksen puoleen laitteen korjaamista varten.
- » Suorita laitteen kytkentä oikein.
- » Katso ohjeet kappaleesta "KytKentä".
- » Suorita laitteen kytkentä oikein.
- » Katso ohjeet kappaleesta "KytKentä".
- » Käänny lähimmän huoltokeskuksen puoleen laitteen korjaamista varten.

Kaaren epävakaisuus

Syy

- » Huono kaasusuojaus.
- » Hitsauskaasussa on kosteutta.

Toimenpide

- » Säädä oikea kaasun virtaus.
- » Tarkista, että polttimen hajotin ja kaasusuulake ovat hyväkuntoisia.
- » Käytä aina hyvälaatuisia tuotteita ja materiaaleja.
- » Pidä kaasusyöttöjärjestelmä aina hyvässä kunnossa.

» Hitsausparametrit väärä.

» Tarkista huolellisesti hitsauslaite.
» Käänny lähimmän huoltokeskuksen puoleen laitteen korjaamista varten.

Runsas roiske

Syy

» Pitkä valokaari.
» Hitsausparametrit väärä.
» Huono kaasusuojaus.
» Valokaaren dynamiikka väärä.
» Hitsauksen suoritustapa väärä.

Toimenpide

» Pienennä elektrodin ja kappaleen välistä etäisyyttä.
» Pienennä hitsattavien kappaleiden.
» Pienennä hitsausvirtaa.
» Säädä oikea kaasun virtaus.
» Tarkista, että polttimen hajotin ja kaasusuulake ovat hyväkuntoisia.
» Kohota piirin induktiivista arvoa.
» Vähennä polttimen kallistumista.

Riittämätön tunkeutuminen

Syy

» Hitsauksen suoritustapa väärä.
» Hitsausparametrit väärä.
» Väärä elektrodi.
» Reunojen valmistelu väärä.
» Maadoituskytkentä virheellinen.
» Huomattavan kokoiset hitsattavat kappaleet.

Toimenpide

» Pienennä hitsauksen etenemisnopeutta.
» Suurena hitsausvirtaa.
» Käytä ohuempaa elektrodia.
» Paranna railomuotoa.
» Suorita maadoituskytkentä oikein.
» Katso ohjeet kappaleessa "Käyttöönotto".
» Suurena hitsausvirtaa.

Kuonasulkeumat

Syy

» Puutteellinen kuonanpoisto.
» Elektrodin halkaisija liian suuri.
» Reunojen valmistelu väärä.
» Hitsauksen suoritustapa väärä.

Toimenpide

» Puhdista kappaleet huolellisesti ennen hitsaamista.
» Käytä ohuempaa elektrodia.
» Paranna railomuotoa.
» Pienennä elektrodin ja kappaleen välistä etäisyyttä.
» Etene säännöllisesti kaikkien hitsausvaiheiden aikana.

Volframin sulkeuma

Syy

» Hitsausparametrit väärä.
» Väärä elektrodi.
» Hitsauksen suoritustapa väärä.

Toimenpide

» Pienennä hitsausvirtaa.
» Käytä paksumpaa elektrodia.
» Käytä aina hyvälaatuisia tuotteita ja materiaaleja.
» Teroita elektrodi oikein.
» Vältä elektrodilla koskemista sulaan.

Huokoisuus

Syy

» Huono kaasusuojaus.

Toimenpide

» Säädä oikea kaasun virtaus.
» Tarkista, että polttimen hajotin ja kaasusuulake ovat hyväkuntoisia.

Takertuminen

Syy

» Pitkä valokaari.
» Hitsausparametrit väärä.
» Hitsauksen suoritustapa väärä.

Toimenpide

» Lisää elektrodin ja työkappaleen välistä etäisyyttä.
» Lisää hitsausjännitettä.
» Suurena hitsausvirtaa.
» Lisää hitsausjännitettä.
» Kallista poltinta mahdollisimman paljon kulman suuntaiseksi.

» Huomattavan kokoiset hitsattavat kappaleet.

» Suurena hitsausvirtaa.

» Lisää hitsausjännitettä.

» Valokaaren dynamiikka väärä.

» Kohota piirin induktiivista arvoa.

Reunahaavat

Syy

» Hitsausparametrit väärä.

» Pitkä valokaari.

» Hitsauksen suoritustapa väärä.

» Huono kaasusuojaus.

Toimenpide

» Pienennä hitsausvirtaa.

» Käytä ohuempaa elektrodia.

» Pienennä elektrodin ja kappaleen välistä etäisyyttä.

» Pienennä hitsattavien kappaleiden.

» Pienennä sivun värähtelynopeutta täytettäessä.

» Pienennä hitsauksen etenemisnopeutta.

» Käytä hitsattaviin materiaaleihin soveltuvia kaasuja.

Hapettuma

Syy

» Huono kaasusuojaus.

Toimenpide

» Säädä oikea kaasun virtaus.

» Tarkista, että polttimen hajotin ja kaasusuulake ovat hyväkuntoisia.

Huokoisuus

Syy

» Rasvaa, maalia, ruostetta tai likaa hitsattavissa kappaleissa.

» Öljyinen, maalinen, ruosteinen tai likainen lisäaine.

» Kosteaa lisäaine.

» Pitkä valokaari.

» Hitsauskaasussa on kosteutta.

» Huono kaasusuojaus.

» Hitsisulan liian nopea jäähmettyminen.

Toimenpide

» Puhdista kappaleet huolellisesti ennen hitsaamista.

» Käytä aina hyvälaatuisia tuotteita ja materiaaleja.

» Pidä lisäaine aina hyvässä kunnossa.

» Käytä aina hyvälaatuisia tuotteita ja materiaaleja.

» Pidä lisäaine aina hyvässä kunnossa.

» Pienennä elektrodin ja kappaleen välistä etäisyyttä.

» Pienennä hitsattavien kappaleiden.

» Käytä aina hyvälaatuisia tuotteita ja materiaaleja.

» Pidä kaasunsyöttöjärjestelmä aina hyvässä kunnossa.

» Säädä oikea kaasun virtaus.

» Tarkista, että polttimen hajotin ja kaasusuulake ovat hyväkuntoisia.

» Pienennä hitsauksen etenemisnopeutta.

» Esikuumenna hitsattavat kappaleet.

» Suurena hitsausvirtaa.

Kuumahalkeamat

Syy

» Hitsausparametrit väärä.

» Rasvaa, maalia, ruostetta tai likaa hitsattavissa kappaleissa.

» Öljyinen, maalinen, ruosteinen tai likainen lisäaine.

» Hitsauksen suoritustapa väärä.

» Hitsattavat kappaleet toisistaan eroavilla ominaisuuksilla.

Toimenpide

» Pienennä hitsausvirtaa.

» Käytä ohuempaa elektrodia.

» Puhdista kappaleet huolellisesti ennen hitsaamista.

» Käytä aina hyvälaatuisia tuotteita ja materiaaleja.

» Pidä lisäaine aina hyvässä kunnossa.

» Suorita toimenpiteet oikeassa järjestyksessä hitsattavan sauman mukaisesti.

» Rasvaa ennen hitsaamista.

Kylmähalkeamat

Syy

» Kosteaa lisäaine.

Toimenpide

» Käytä aina hyvälaatuisia tuotteita ja materiaaleja.

» Pidä lisäaine aina hyvässä kunnossa.

» Hitsattavan liitoksen erikoinen muoto.

- » Esikuumenna hitsattavat kappaleet.
- » Suorita jälkilämpökäsittely.
- » Suorita toimenpiteet oikeassa järjestyksessä hitsattavan sauman mukaisesti.

9. KÄYTTÖOHJEET

9.1 Puikkohitsaus (MMA)

Reunojen viimeistely

Jotta saavutettaisiin hyvä hitsausauma tulee liituskappaleiden olla puhtaita liasta ja ruosteesta.

Puikon valinta

Käytettävän hitsauspuikon halkaisija riippuu materiaalin paksuudesta, asennosta, liitoksen tyylistä sekä hitsattavan kappaleen valmistustavasta.

Suuremman läpimitan omaavat hitsauspuikot vaativat suuremman hitsausvirran ja tuottavat paljon lämpöä hitsatessa.

Hitsauspuikon tyyppi	Puikon ominaisuus	Käyttökohde
Rutiilipuikko	Helppo hitsattavuus	Kaikkiin
Haponkestävä puikko	Suuri sulamisnopeus	Tasaisiin
Emäspuikko	Mekaaniset ominaisuudet	Kaikkiin

Hitsausvirran valinta

Hitsauspuikon valmistaja on määritellyt oikean hitsausvirran alueen kullekin puikotyyppille erikseen. Ohjeet sopivan hitsausvirran raja-arvoista löytyvät hitsauspuikkopakkauksesta.

Valokaaren sytytys ja sen ylläpito

Hitsausvalokaari sytytetään raapimalla hitsauspuikon päätä maadoitettuun työkappaleeseen. Hitsauspuikon päätä vedetään pois työkappaleesta normaaliin työetäisyyteen heti, kun valokaari on syttynyt.

Hitsauspuikon sytyttämisen helpottamiseksi hitsauskoneessa on toiminto, joka kohottaa hitsausjännitettä hetkellisesti (Hot Start)

Kun valokaari on syttynyt, hitsauspuikon sisäosa sulaa ja siirtyy pisaroiden muodossa työkappaleeseen.

Hitsauspuikossa ulompänä oleva lisäaineosa kaasuntuu ja muodostaa suojakaasun ja mahdollistaa korkeatasoisen hitsausauman.

Hitsauskoneessa on toiminto, joka ehkäisee sulan metallin roiskeiden aiheuttaman valokaaren sammumisen (Arc Force).

Siinä tapauksessa, että hitsauspuikko juuttuu kiinni hitsattavaan kappaleeseen tulee oikosulkuvirta vähentää minimiin (antisticking).

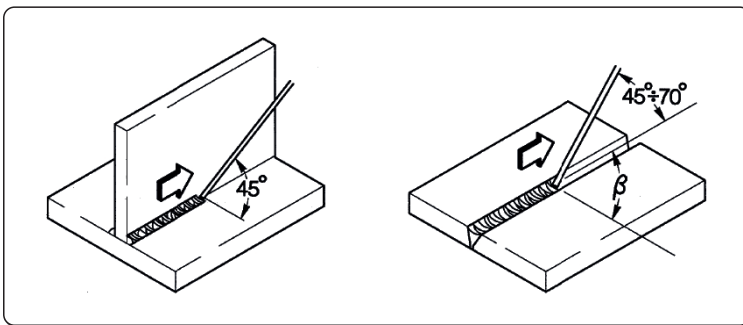

Hitsaaminen

Hitsauspuikon kulma työkappaleeseen nähdessä vaihtelee sen mukaan, kuinka moneen kertaan sauma hitsataan; normaalisti hitsauspuikkoa heilutetaan sauman puolelta toiselle pysähtyen sauman reunalla. Näin vältetään täyteaineen kasautuminen sauman keskelle.

Kuonan poisto

Puikkohitsaukseen sisältyy kuonan poisto jokaisen hitsausvaiheen jälkeen.

Kuona poistetaan kuonahakulla ja teräsharjalla.

9.2 TIG-hitsaus (jatkuva kaari)

Kuvaus

TIG (Tungsten Inert Gas)-hitsausprosessi perustuu valokaaren sulamattoman hitsauspuikon (tavallisesti puhdasta tai sekoitettua volframia, sulamispiste n. 3370°C) ja työkalpaleen välillä. Hitsaustapahtuma suojataan Argon-suojakaasulla.

Jotta vältetään volframin vaaralliselta syttymiseltä liitoksessa, ei elektrodi saa koskaan päästä kosketukseen hitsattavan kappaleen kanssa. Tämän vuoksi kehitetään HF-generaattorilla suoja, jonka avulla sytytys voi tapahtua sähköisen valokaaren ulkopuolella. Laitteen avulla valokaari saadaan syttymään jo varsin etäällä työkalpaleesta.

Toisenlainen valokaaren sytytys on myös mahdollinen: ns. nostosytytys, joka ei vaadi korkeataajuussytytyslaitetta, vaan lyhyen oikosulun alhaisella virralla puikon ja työkalpaleen välille. Kun puikkoa tällöin nostetaan, valokaari syttyy ja hitsausvirta lisääntyy kunnes se saavuttaa oikeat hitsausarvot. Tavanomainen raapaisu-sytytys ei toisaalta takaa korkealuokkaista hitsaussaamaa sauman alussa.

Hitsauslangan loppupään laadun parantamiseksi on hyvä seurata hitsausvirran vähenemistä tarkoin; kaasun tulee myös virrata muutaman sekunnin ajan hitsisulassa valokaaren sammumisen jälkeen.

Monissa työskentelyolosuhteissa on hyvä käyttää kahta valmiiksi asetettua hitsausvirtaa, jolloin voidaan siirtyä helposti yhdestä toiseen (BILEVEL).

Hitsausnapaisuus

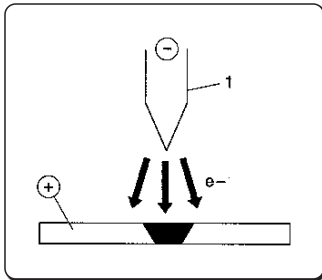

Normaali napaisuus (-napa polttimessa)

Edellä mainittua napaisuutta käytetään eniten, sillä tällöin 70% lämmöstä johtuu työkalpaleeseen ja hitsauspuikon (1) kulumisen on vähäistä.

Em. napaisuudella pystytään hitsaamaan syviä ja kapeita hitsaussaumoja nopeasti ja ilman turhaa lämmönmuodostusta.

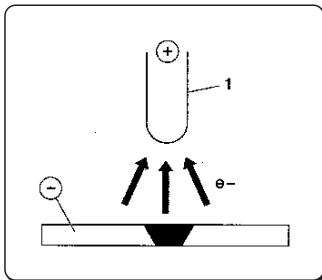

Käänteinen napaisuus (+napa polttimessa)

Käänteistä napaisuutta käytetään hitsattaessa seosmetalleja, joissa on pinnalla korkean sulamispisteen omaavaa hapettumakerros.

Korkeita hitsausvirtoja ei kuitenkaan voida käyttää, koska se aiheuttaisi puikon nopean kulumisen käyttökelvottomaksi.

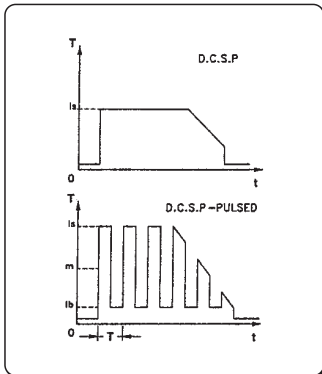

D.C.S.P.-Pulsed (Direct Current Straight Polarity Pulsed)

Yhden jatkuvan vaihtovirran käyttö helpottaa hitsisulan kontrollia erityisissä työskentelyolosuhteissa.

Hitsisula muodostuu materiaalin sulaneista kohdista (I_p), kantavirta taas (I_b) pitää valokaaren palamassa; tämä helpottaa ohuiden materiaalien hitsausta, jolloin muodostuu pienempiä vääntymiä, muoto säilyy parempana, ja vastaavasti lämpöhalkeamien ja kaasusulkeumien riski vähenee.

Suuremmalla taajuudella (keskimääräinen taajuus) saadaan kapeampi, lyhyempi ja vakaampi valokaari ja ohuiden materiaalien parantunut hitsaustulos.

TIG-hitsin ominaisuudet

TIG-hitsaus on osoittautunut erittäin tehokkaaksi hitsattaessa sekä hiilliterästä että seostettua terästä, putkien ensimmäisissä palkoissa ja hitsauksissa, joissa ulkonäöllä on merkitystä.

Vaaditaan hitsausta negatiivisilla navoilla (D.C.S.P)

Reunojen viimeistely

Toimenpide vaatii reunojen huolellisen puhdistuksen ja tarkan valmistelun.

Puikon valinta

On suositeltavaa käyttää torium-volframelektrodiä (2% punaista torium-väriä) tai vaihtoehtoisesti cerium- tai lantaanisekoitteisia elektrodeja, joiden läpimitat ovat seuraavat:

Hitsausvirta			Elektrodi	
(DC-)	(DC+)	(AC)	Ø	α
3-20 A	-	3-20 A	0,5 mm	30°
15-80 A	-	20-30 A	1,0 mm	30-60°
70-150 A	10-20 A	30-80 A	1,6 mm	60-90°
150-250 A	15-30 A	60-130 A	2,4 mm	90-120°
250-400 A	25-40 A	100-180 A	3,2 mm	120-150°
400-500 A	40-55 A	160-240 A	4,0 mm	150-180°
500-750 A	55-80 A	190-300 A	4,8 mm	150-180°
750-1100 A	80-125 A	325-450 A	6,4 mm	150-180°

Puikko tulee teroittaa kuvan osoittamalla tavalla.

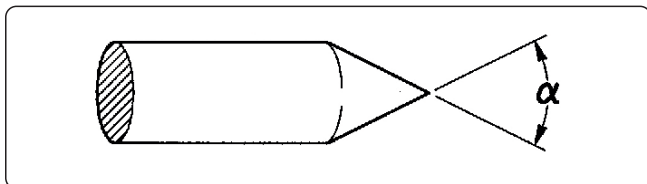

Hitsausmateriaali

Hitsauspuikon ominaisuuksien on aina vastattava työkappaleen aineen ominaisuuksia.

Älä käytä työkappaleesta irrotettuja palasia lisäaineena, sillä ne saattavat sisältää epäpuhtauksia.

Suojakaasu

Suojakaasuna käytetään TIG-hitsauksessa käytännöllisesti katsoen vain puhdasta argonia (99.99%).

Hitsausvirta			Kaasu	
(DC-)	(DC+)	(AC)	Suutin	Virtaus
3-20 A	-	3-20 A	n° 4	5-6 l/min
15-80 A	-	20-30 A	n° 5	6-8 l/min
70-150 A	10-20 A	30-80 A	n° 6	7-10 l/min
150-250 A	15-30 A	60-130 A	n° 7	8-12 l/min
250-400 A	25-40 A	100-180 A	n° 8	10-14 l/min
400-500 A	40-55 A	160-240 A	n° 8	12-16 l/min
500-750 A	55-80 A	190-300 A	n° 10	15-20 l/min
750-1100 A	80-125 A	325-450 A	n° 12	20-25 l/min

10. TEKNISET OMINAISUUDET

Sähköiset ominaisuudet			U.M.
Syöttöjännite U1 (50/60 Hz)	3x230 (±15%)	3x400 (±15%)	Vac
Zmax (@PCC) *	53	53	mΩ
Hidastettu linjasulake	25	16	A
Tiedonsiirtoväylä	DIGITAALINEN	DIGITAALINEN	
Maksimi ottoteho	10.5	10.5	kVA
Maksimi ottoteho	10.1	10.1	kW
Ottoteho valmiustilassa	51	51	W
Tehokerroin (PF)	0.96	0.96	
Hyötysuhde (μ)	83	83	%
Cos φ	0.99	0.99	
Maksimi ottovirta I1max	30.8	15.3	A
Tehollinen virta I1eff	18	9	A
Säätöalue	3-270	3-270	A
Tyhjäkäyntijännite Uo	80	80	Vdc
Huippujännite Up	10.1	10.1	kV

* Tämä laite ole standardin EN / IEC 61000-3-11 mukainen.

* Tämä laite täyttää standardin EN / IEC 61000-3-12 vaatimukset, jos liitäntä yleiseen sähköverkkoon tapahtuu pisteessä (PCC), jonka suurin impedanssi on pienempi tai yhtä suuri kuin ilmoitettu arvo "Zmax". Jos se kytketään julkiseen matalajännitteverkkoon, on laitteen asentajan tai käyttäjän vastuulla varmistaa, tarvittaessa yhdessä sähköyhtiön edustajan kanssa, että laitteen kytkeminen on luvallista.

Käyttökerroin	3x230V	3x400V	U.M.
Käyttökerroin (40°C)			
(X=35%)	270	270	A
(X=60%)	230	230	A
(X=100%)	180	180	A
Käyttökerroin (25°C)			
(X=80%)	270	270	A
(X=100%)	240	240	A

Fyysiset ominaisuudet			U.M.
IP-luokitus	IP23S		
Eristysluokka	H		
Mitat (lxdxh)	500x190x400		mm
Paino	18.8		Kg
Kappale syöttökaapeli	4x4		mm ²
Virtakaapelin pituus	5		m
Standardit	EN IEC 60974-1/A1:2019 EN IEC 60974-3:2019 EN 60974-10/A1:2015		

11. ARVOKILPI

VOESTALPINE BÖHLER WELDING SELCO S.R.L. Via Palladio,19 - ONARA (PADOVA) - ITALY					
URANOS NX 2700 TLH			N°		
		EN 60974-1/A1:2019 IEC 60974-10/A1:2015 Class A		60974-3:2019	
Up 10.1 kV					
3A/10.0V - 270A (270A)/20.8V (20.8V)					
X (40°C)					
35% 60% 100%					
S	U ₀	I _z	270A (270A)	230A (230A)	180A (180A)
	80V	U _z	20.8V (20.8V)	19.2V (19.2V)	17.2V (17.2V)
3A/20.0V - 270A (270A)/30.8V (30.8V)					
X (40°C)					
35% 60% 100%					
S	U ₀	I _z	270A (270A)	230A (230A)	180A (180A)
	80V	U _z	30.8V (30.8V)	29.2V (29.2V)	27.2V (27.2V)
3-50/60 Hz		U ₁ 400V(230V)	I _{1max} 15.3A(30.8A)	I _{1eff} 9A(18A)	
IP 23 S					
MADE IN ITALY					

12. KILVEN SISÄLTÖ

1		2			
3		4			
5		6			
7	9	23			
		11			
8	10	12	15	16	17
		13	15A	16A	17A
		14	15B	16B	17B
7	9	11			
		12	15	16	17
8	10	13	15A	16A	17A
		14	15B	16B	17B
		18	19	20	21
22					
MADE IN ITALY					

CE EU-vaatimustenmukaisuusvakuutus
 EAC EAC-vaatimustenmukaisuusvakuutus
 UKCA UKCA-vaatimustenmukaisuusvakuutus

- 1 Kaupallinen merkki
- 2 Valmistajan nimi ja osoite
- 3 Laitteen malli
- 4 Sarjanro
- XXXXXXXXXXXXXX Valmistusvuosi
- 5 Hitsauskoneen tyyppin symboli
- 6 Viittaus rakennestandardeihin
- 7 Hitsausprosessin symboli
- 8 Symboli, jonka mukaan hitsauskonetta voidaan käyttää ympäristössä, jossa on lisääntynyt sähköiskun vaara
- 9 Hitsausvirran symboli
- 10 Nimellistyhjäkäyntijännite
- 11 Nimellishitsausvirran sekä vastaavan tavanomaisen työjännitteen suurimmat ja pienimmät arvot
- 12 Katkohitsausjakson symboli
- 13 Nimellishitsausvirran symboli
- 14 Nimellishitsausjännitteen symboli
- 15 Katkohitsausjakson arvot
- 16 Katkohitsausjakson arvot
- 17 Katkohitsausjakson arvot
- 15A Nimellishitsausvirran arvot
- 16A Nimellishitsausvirran arvot
- 17A Nimellishitsausvirran arvot
- 15B Tavanomaisen työjännitteen arvot
- 16B Tavanomaisen työjännitteen arvot
- 17B Tavanomaisen työjännitteen arvot
- 18 Virtalähteen symboli
- 19 Nimellisliitäntäjännite
- 20 Suurin nimellisliitäntävirta
- 21 Suurin tehollisliitäntävirta
- 22 Suojausluokka
- 23 Nimellishuippujännite

ΔΗΛΩΣΗ ΣΥΜΜΟΡΦΩΣΗΣ ΕΥ

Ο οικοδόμος

voestalpine Böhler Welding Selco S.r.l. - Via Palladio, 19 - 35019 Onara di Tombolo (PD) - ITALY
Tel. +39 049 9413/111 - Fax +39 049 9413/311 - www.voestalpine.com/welding

δηλώνει με αποκλειστική ευθύνη ότι το ακόλουθο προϊόν:

URANOS NX 2700 TLH

55.07.042

55.07.043

είναι κατασκευασμένη σε συμμόρφωση με τις Ευρωπαϊκές Οδηγίες:

2014/35/EU LOW VOLTAGE DIRECTIVE

2014/30/EU EMC DIRECTIVE

2011/65/EU RoHS DIRECTIVE

2019/1784/EU EcoDesign

2009/125/EU EcoDesign

και ότι έχουν εφαρμοστεί τα ακόλουθα εναρμονισμένα πρότυπα:

EN IEC 60974-1/A1:2019

WELDING POWER SOURCE

EN IEC 60974-3:2019

ARC STRIKING AND STABILIZING DEVICES

EN 60974-10/A1:2015

ELECTROMAGNETIC COMPATIBILITY REQUIREMENTS

Η τεκμηρίωση που πιστοποιεί τη συμμόρφωση με τις οδηγίες θα παραμείνει διαθέσιμη για επιθεωρήσεις στον προαναφερόμενο κατασκευαστή.

Τυχόν επεμβάσεις ή τροποποιήσεις που θα γίνουν χωρίς την εξουσιοδότηση της **voestalpine Böhler Welding Selco S.r.l.**, θα προκαλέσουν την παύση ισχύος της παραπάνω δήλωσης.

Onara di Tombolo, 01/07/2024

voestalpine Böhler Welding Selco s.r.l.



Mirco Frasson Ivo Bonello

Managing Directors

ΠΕΡΙΕΧΟΜΕΝΑ

1. ΠΡΟΕΙΔΟΠΟΙΗΣΕΙΣ	404
1.1 Περιβάλλον χρήσης	404
1.2 Ατομική προστασία και ασφάλεια τρίτων	404
1.3 Προστασία από καπνούς και αέρια	405
1.4 Πρόληψη πυρκαγιάς/έκρηξης	406
1.5 Προληπτικά μέτρα για τη χρήση φιαλών αερίου	406
1.6 Προστασία από ηλεκτροπληξία	406
1.7 Ηλεκτρομαγνητικά πεδία και παρεμβολές	406
1.8 Βαθμός προστασίας IP	408
1.9 Διάθεση.....	408
2. ΕΓΚΑΤΑΣΤΑΣΗ.....	408
2.1 Τρόπος ανύψωσης, μεταφοράς και εκφόρτωσης	408
2.2 Τοποθέτηση της διάταξης	408
2.3 Σύνδεση.....	408
2.4 Θέση σε λειτουργία.....	409
3. ΠΑΡΟΥΣΙΑΣΗ ΤΗΣ ΔΙΑΤΑΞΗΣ	410
3.1 Πίσω πάνελ	410
3.2 Πίνακας υποδοχών	410
3.3 Μπροστινός πίνακας ελέγχου.....	411
4. ΧΡΗΣΗ ΤΟΥ ΕΞΟΠΛΙΣΜΟΥ	412
4.1 Σελίδα εκκίνησης	412
4.2 Αρχική σελίδα	412
4.3 Κεντρική οθόνη διαδικασίας MMA	412
5. SETUP	416
5.1 Set up και τη ρύθμιση των παραμέτρων.....	416
5.2 Ειδικές διαδικασίες χρήσης των παραμέτρων	423
6. ΣΥΝΤΗΡΗΣΗ.....	426
6.1 Περιοδικοί έλεγχοι.....	427
6.2 Ευθύνη	427
7. ΚΩΔΙΚΟΙ ΣΥΝΑΓΕΡΜΩΝ (ΑΛΑΡΜ).....	427
8. ΔΙΑΓΝΩΣΗ ΠΡΟΒΛΗΜΑΤΩΝ ΚΑΙ ΛΥΣΕΙΣ	429
9. ΟΔΗΓΙΕΣ ΧΡΗΣΗΣ.....	432
9.1 Συγκόλληση με επενδυμένο ηλεκτρόδιο (MMA)	432
9.2 Συγκόλληση TIG (συνεχές τόξο).....	433
10. ΤΕΧΝΙΚΑ ΧΑΡΑΚΤΗΡΙΣΤΙΚΑ	435
11. ΠΙΝΑΚΙΔΑ ΧΑΡΑΚΤΗΡΙΣΤΙΚΩΝ	436
12. ΣΗΜΑΣΙΑ ΠΙΝΑΚΙΔΑΣ ΧΑΡΑΚΤΗΡΙΟΤΙΚΩΝ	436
13. ΔΙΑΓΡΑΜΜΑ.....	438
14. ΣΥΝΔΕΤΗΡΕΣ	440
15. ΚΑΤΑΛΟΓΟΣ SKIP	441

ΣΥΜΒΟΛΑ



Προειδοποιήσεις



Απαγορεύσεις



Υποχρεώσεις



Γενικές ενδείξεις

1. ΠΡΟΕΙΔΟΠΟΙΗΣΕΙΣ



Πριν προβείτε σε οποιαδήποτε ενέργεια, πρέπει να διαβάσετε και να είστε βέβαιοι ότι κατανοήσατε το παρόν εγχειρίδιο. Μην κάνετε μετατροπές και ενέργειες συντήρησης που δεν περιγράφονται στο παρόν. Ο κατασκευαστής δε φέρει καμία ευθύνη για τυχόν βλάβες, σε πρόσωπα ή πράγματα, που οφείλονται σε πλημμελή ανάγνωση και/ή μη εφαρμογή των οδηγιών του παρόντος εγχειριδίου.

Διατηρείτε πάντα τις οδηγίες χρήσης στον τόπο χρήσης της συσκευής. Εκτός από τις οδηγίες χρήσης, τηρείτε τους γενικούς κανόνες και τους ισχύοντες τοπικούς κανονισμούς για την πρόληψη των ατυχημάτων και την προστασία του περιβάλλοντος.

voestalpine Böhler Welding Selco S.r.l. διατηρεί το δικαίωμα να επιφέρει αλλαγές, ανά πάσα στιγμή και χωρίς καμία προειδοποίηση. Με την επιφύλαξη όλων των δικαιωμάτων.

Απαγορεύεται η μερική ή ολική αναπαραγωγή, η προσαρμογή και η μετάφραση των εγγράφων, με οποιοδήποτε μέσο (συμπεριλαμβανομένων των φωτοτυπιών, φιλμ και μικροφίλμ), χωρίς την έγγραφη εξουσιοδότηση της **voestalpine Böhler Welding Selco S.r.l.**

Τα προαναφερθέντα είναι ζωτικής σημασίας και, κατά συνέπεια, απαραίτητα για την ισχύ των εγγυήσεων.

Ο κατασκευαστής δεν φέρει καμία ευθύνη, σε περίπτωση που ο χειριστής δε συμμορφωθεί με τις οδηγίες.



Όλοι οι υπεύθυνοι για τη θέση σε λειτουργία, τη χρήση, τη συντήρηση και την επισκευή της συσκευής πρέπει:

- να διαθέτουν κατάλληλη εξειδίκευση
- να διαθέτουν τις αναγκαίες δεξιότητες για τις συγκολλήσεις
- να έχουν διαβάσει πλήρως και να τηρούν σχολαστικά τις παρούσες οδηγίες χρήσης

Για κάθε αμφιβολία ή πρόβλημα σχετικά με τη χρήση της διάταξης, έστω κι αν δεν περιγράφεται εδώ, συμβουλευτείτε κάποιον εξειδικευμένο τεχνικό.

1.1 Περιβάλλον χρήσης



Κάθε διάταξη πρέπει να χρησιμοποιείται αποκλειστικά και μόνο για τις λειτουργίες που σχεδιάστηκε, με τους τρόπους και το εύρος τιμών που αναγράφονται στην πινακίδα χαρακτηριστικών και/ή στο παρόν εγχειρίδιο, και σύμφωνα με τους εθνικούς και διεθνείς κανονισμούς ασφαλείας. Οποιαδήποτε άλλη χρήση, που διαφέρει από αυτές που δηλώνει ρητά ο Κατασκευαστής, θεωρείται απολύτως ανάρμοστη και επικίνδυνη, και, στην περίπτωση αυτή, ο Κατασκευαστής δε φέρει καμία ευθύνη.



Η συσκευή πρέπει να προορίζεται μόνο για επαγγελματική χρήση, σε βιομηχανικό περιβάλλον. Ο κατασκευαστής δε φέρει καμία ευθύνη για βλάβες που ενδεχομένως προκληθούν εξαιτίας της χρήσης της διάταξης μέσα σε κατοικίες.



Η διάταξη πρέπει να χρησιμοποιείται σε χώρους με θερμοκρασία μεταξύ -10°C και $+40^{\circ}\text{C}$ ($+14^{\circ}\text{F}$ και $+104^{\circ}\text{F}$).

Η διάταξη πρέπει να μεταφέρεται και να αποθηκεύεται σε χώρους με θερμοκρασία μεταξύ -25°C και $+55^{\circ}\text{C}$ (-13°F και 131°F).

Η διάταξη πρέπει να χρησιμοποιείται σε περιβάλλον χωρίς σκόνη, οξέα, αέρια ή άλλες διαβρωτικές ουσίες.

Η διάταξη πρέπει να χρησιμοποιείται σε περιβάλλον με σχετική υγρασία μικρότερη του 50%, στους 40°C ($40,00^{\circ}\text{C}$).

Η διάταξη πρέπει να χρησιμοποιείται σε περιβάλλον με σχετική υγρασία μικρότερη του 90%, στους 20°C (68°F).

Το μέγιστο επιτρεπόμενο υψόμετρο για τη χρήση της διάταξης είναι 2000 μ. (6500 πόδια).



Μη χρησιμοποιείτε αυτή τη συσκευή για να ξεπαγώνετε σωληνώσεις.

Μη χρησιμοποιείτε τη συσκευή για φόρτιση μπαταριών ή/και συσσωρευτών.

Μη χρησιμοποιείτε τη συσκευή για την εκκίνηση κινητήρων.

1.2 Ατομική προστασία και ασφάλεια τρίτων



Η διαδικασία συγκόλλησης αποτελεί πηγή βλαβερών ακτινοβολιών, θορύβου, θερμότητας και εκπομπής αερίων. Τοποθετήστε διαχωριστικό πυρίμαχο τοίχωμα, για να προστατεύεται η ζώνη συγκόλλησης από ακτίνες, σπινθήρες και πυρακτωμένα κομμάτια σκουριάς. Κάντε συστάσεις στους παρόντες να μην κοιτάζουν τη συγκόλληση και να προστατεύονται από τις ακτίνες του τόξου ή το πυρακτωμένο μέταλλο.



Φοράτε κατάλληλο ρουχισμό, που να προστατεύει το δέρμα από την ακτινοβολία του τόξου, τους σπινθήρες και/ή το πυρακτωμένο μέταλλο. Τα ρούχα που φοράτε πρέπει να καλύπτουν όλο το σώμα και πρέπει να είναι:

- Ακέραια και σε καλή κατάσταση
- Πυρίμαχα
- Μονωτικά και στεγνά
- Εφαρμοστά στο σώμα και χωρίς ρεβέρ



Φοράτε πάντοτε υποδήματα εγκεκριμένα σύμφωνα με τα σχετικά πρότυπα, ανθεκτικά και ικανά να εξασφαλίσουν τη μόνωση από το νερό.



Φοράτε πάντοτε γάντια, εγκεκριμένα με βάση τα σχετικά πρότυπα, που να εξασφαλίζουν την ηλεκτρική και θερμική μόνωση.



Για την προστασία των ματιών, χρησιμοποιείτε μάσκες με πλευρική προστασία για το πρόσωπο και κατάλληλο βαθμό προστασίας (Β.Π. 10 ή ανώτερος).



Φοράτε πάντα προστατευτικά γυαλιά με πλευρικά καλύμματα, ειδικά κατά τις ενέργειες χειροκίνητης ή μηχανικής απομάκρυνσης της σκουριάς συγκόλλησης (κοπή).



Μη φοράτε φακούς επαφής!



Φοράτε ωτοασπίδες, σε περίπτωση που η διαδικασία συγκόλλησης παρουσιάζει επικίνδυνη στάθμη θορύβου. Αν η στάθμη θορύβου υπερβαίνει τα όρια του νόμου, οριοθετήστε τη ζώνη εργασίας και βεβαιωθείτε ότι οι παρόντες προστατεύονται με ωτοασπίδες ή ωτοβύσματα.



Διατηρείτε πάντα τα πλευρικά τοιχώματα κλειστά, κατά τη διάρκεια των εργασιών συγκόλλησης. Απαγορεύεται οποιαδήποτε μετατροπή της διάταξης.



Αποφύγετε την επαφή με κομμάτια, αμέσως μετά τη συγκόλληση. Η υψηλή θερμοκρασία μπορεί να προκαλέσει σοβαρά εγκαύματα.



Οι παραπάνω προφυλάξεις πρέπει να τηρούνται και στις εργασίες μετά τη συγκόλληση, γιατί μπορεί να αποκολλούνται κομμάτια σκουριάς από τα επεξεργασμένα κομμάτια που ψύχονται.



Πριν κάνετε κάποια ενέργεια πάνω στην τσιμπίδα ή προβείτε στη συντήρησή της, βεβαιωθείτε ότι έχει κρυώσει.



Πριν αποσυνδέσετε τους σωλήνες προσαγωγής και επιστροφής του ψυκτικού υγρού, βεβαιωθείτε ότι η μονάδα ψύξης είναι σβηστή. Το θερμό υγρό που βγαίνει μπορεί να προκαλέσει σοβαρά εγκαύματα.



Προμηθευτείτε τα απαραίτητα μέσα πρώτων βοηθειών.
Μην παραμελείτε τυχόν εγκαύματα ή τραυματισμούς.



Πριν εγκαταλείψετε τη θέση εργασίας, πάρτε τα απαραίτητα μέτρα ασφαλείας, για να αποφευχθούν ακούσιες βλάβες και ατυχήματα.

1.3 Προστασία από καπνούς και αέρια



Οι καπνοί, τα αέρια και οι σκόνες που παράγονται από τη διαδικασία συγκόλλησης, μπορεί να αποδειχθούν επιβλαβή για την υγεία. Υπό ορισμένες συνθήκες, οι καπνοί που παράγονται από τη συγκόλληση μπορεί να προκαλέσουν καρκίνο ή, στις έγκυες γυναίκες, βλάβες στο έμβρυο.

- Κρατάτε το κεφάλι μακριά από τα αέρια και τους καπνούς της συγκόλλησης.
- Η ζώνη εργασίας πρέπει να διαθέτει κατάλληλο σύστημα φυσικού ή βεβαιασμένου αερισμού.
- Σε περίπτωση ανεπαρκούς αερισμού, χρησιμοποιήστε μάσκες με αναπνευστήρες.
- Σε περίπτωση συγκολλήσεων σε χώρους μικρών διαστάσεων, σας συνιστούμε την επίβλεψη του συγκολλητή από κάποιο συνάδελφο, που βρίσκεται έξω από το συγκεκριμένο χώρο.
- Μη χρησιμοποιείτε οξυγόνο για τον εξαερισμό.
- Για να ελέγχετε την αποτελεσματικότητα της αναρρόφησης, συγκρίνετε κατά περιόδους την ποσότητα των εκπομπών επιβλαβών αερίων με τις επιτρεπτές τιμές που αναγράφονται στους κανονισμούς ασφαλείας.
- Η ποσότητα και η επικινδυνότητα των παραγόμενων καπνών εξαρτάται από το βασικό υλικό που χρησιμοποιείται, από το υλικό συγκόλλησης και από ενδεχόμενες ουσίες που χρησιμοποιούνται για καθαρισμό και απολίπανση των κομματιών που συγκολλούνται. Ακολουθήστε πιστά τις οδηγίες του κατασκευαστή και των σχετικών τεχνικών δελτίων.
- Μην κάνετε συγκολλήσεις (κοπές) κοντά σε χώρους απολίπανσης ή βαφής.
- Τοποθετείτε τις φιάλες αερίου σε ανοικτούς χώρους ή σε χώρους με καλή κυκλοφορία του αέρα.

1.4 Πρόληψη πυρκαγιάς/έκρηξης



Η διαδικασία συγκόλλησης μπορεί να αποτελέσει αιτία πυρκαγιάς και/ή έκρηξης.

- Απομακρύνετε, από τη ζώνη εργασίας και τη γύρω περιοχή, τα εύφλεκτα ή καύσιμα υλικά και αντικείμενα.
- Τα εύφλεκτα υλικά πρέπει να βρίσκονται σε απόσταση τουλάχιστον 11 μέτρων (35 ποδιών) από το χώρο συγκόλλησης ή πρέπει να προστατεύονται κατάλληλα.
- Οι σπινθήρες και τα πυρακτωμένα σωματίδια που εκσφενδονίζονται μπορούν να φτάσουν εύκολα στις γύρω περιοχές ακόμη και από πολύ μικρά ανοίγματα. Προσέξτε ιδιαίτερα την ασφάλεια πραγμάτων και ατόμων.
- Μην κάνετε συγκολλήσεις πάνω ή κοντά σε δοχεία που βρίσκονται υπό πίεση.
- Μην εκτελείτε εργασίες συγκόλλησης σε κλειστά δοχεία ή σωλήνες. Επίσης, ιδιαίτερη προσοχή απαιτείται κατά τη συγκόλληση σωλήνων ή δοχείων, έστω και αν αυτά είναι ανοιχτά, άδεια και προσεκτικά καθαρισμένα. Τυχόν υπολείμματα αερίων, καυσίμων, λαδιού ή παρόμοιων ουσιών, μπορεί να προκαλέσουν εκρήξεις.
- Μην κάνετε συγκολλήσεις σε ατμόσφαιρα που περιέχει σκόνη, εκρηκτικά αέρια ή αναθυμιάσεις.
- Μετά τη συγκόλληση, βεβαιωθείτε ότι το ηλεκτρικό κύκλωμα δεν ακουμπά κατά λάθος σε επιφάνειες συνδεδεμένες με το κύκλωμα της γείωσης.
- Κοντά στη ζώνη εργασίας πρέπει να υπάρχει εξοπλισμός ή σύστημα πυρασφαλείας.

1.5 Προληπτικά μέτρα για τη χρήση φιαλών αερίου



Οι φιάλες αδρανούς αερίου περιέχουν αέριο υπό πίεση και μπορούν να εκραγούν, σε περίπτωση που δεν τηρούνται οι ελάχιστες συνθήκες ασφαλείας μεταφοράς, αποθήκευσης και χρήσης.

- Οι φιάλες πρέπει να είναι σταθερά στερεωμένες, σε κατακόρυφη θέση, πάνω σε τοίχους ή με άλλα κατάλληλα μέσα, για να αποφεύγονται πτώσεις ή τυχαία χτυπήματα.
- Βιδώνετε το κάλυμμα προστασίας της βαλβίδας κατά τη μεταφορά και την τοποθέτηση, καθώς και κάθε φορά που ολοκληρώνονται οι διαδικασίες συγκόλλησης.
- Αποφύγετε την έκθεση των φιαλών στην άμεση ηλιακή ακτινοβολία και σε απότομες μεταβολές θερμοκρασίας. Μην εκτίθετε τις φιάλες σε πολύ χαμηλές ή πολύ υψηλές θερμοκρασίες.
- Αποφύγετε την επαφή των φιαλών με ελεύθερες φλόγες, ηλεκτρικά τόξα, τσιμπίδες συγκόλλησης ή ηλεκτροδίων και πυρακτωμένων θραυσμάτων που παράγονται από τη συγκόλληση.
- Κρατήστε τις φιάλες μακριά από τα κυκλώματα συγκόλλησης και από ηλεκτρικά κυκλώματα γενικότερα.
- Κρατάτε το κεφάλι μακριά από το σημείο εξόδου του αερίου, όταν ανοίγετε τη βαλβίδα της φιάλης.
- Κλείνετε πάντα τη βαλβίδα της φιάλης, αφού ολοκληρώσετε τις εργασίες συγκόλλησης.
- Μην εκτελείτε ποτέ συγκολλήσεις σε φιάλες αερίου που βρίσκονται υπό πίεση.
- Μην συνδέετε ποτέ τη φιάλη πεπιεσμένου αέρα απευθείας στο μειωτήρα πίεσης του μηχανήματος! Η πίεση μπορεί να υπερβεί την ισχύ του μειωτήρα πίεσης και, κατά συνέπεια, να προκαλέσει έκρηξη!

1.6 Προστασία από ηλεκτροπληξία



Η ηλεκτροπληξία μπορεί να προκαλέσει θάνατο.

- Αποφύγετε την επαφή με τα σημεία που βρίσκονται συνήθως υπό τάση, στο εσωτερικό ή στο εξωτερικό της διάταξης συγκόλλησης, όταν η διάταξη έχει ρεύμα (οι τσιμπίδες, τα σώματα γείωσης, τα καλώδια γείωσης, τα ηλεκτρόδια, τα καλώδια, τα ράουλα και τα καρούλια συνδέονται με το ηλεκτρικό κύκλωμα συγκόλλησης).
- Εξασφαλίστε την ηλεκτρική μόνωση της εγκατάστασης και του χειριστή, χρησιμοποιώντας στεγνές επιφάνειες και βάσεις, με επαρκή μόνωση από το δυναμικό του εδάφους και της γείωσης.
- Βεβαιωθείτε ότι η εγκατάσταση συνδέεται σωστά, σε κάποια πρίζα και σε δίκτυο που διαθέτουν αγωγό γείωσης.
- Ο χειριστής δεν πρέπει να αγγίζει ταυτόχρονα δύο τσιμπίδες ηλεκτροδίων.
- Διακόψτε αμέσως τη συγκόλληση, εάν νιώσετε ότι σας διαπερνά ηλεκτρικό ρεύμα.



Η διάταξη έναυσης και σταθεροποίησης του τόξου είναι σχεδιασμένη για λειτουργία με χειροκίνητο ή μηχανικό έλεγχο.



Η αύξηση του μήκους της τσιμπίδας ή των καλωδίων συγκόλλησης πάνω από τα 8 μ., αυξάνει το κίνδυνο ηλεκτροπληξίας.

1.7 Ηλεκτρομαγνητικά πεδία και παρεμβολές



Η διέλευση του ρεύματος από τα εσωτερικά και εξωτερικά καλώδια της διάταξης, δημιουργεί ηλεκτρομαγνητικό πεδίο κοντά στα καλώδια συγκόλλησης και στην ίδια τη διάταξη.

- Τα ηλεκτρομαγνητικά πεδία μπορεί να έχουν (άγνωστες μέχρι σήμερα) επιπτώσεις στην υγεία, μετά από παρατεταμένη έκθεση.
- Τα ηλεκτρικά πεδία μπορούν να προκαλέσουν παρεμβολές σε άλλες ηλεκτρικές συσκευές, όπως στους βηματοδότες ή στα ακουστικά βαρηκοΐας.



Τα άτομα με ζωτικές ηλεκτρονικές συσκευές (βηματοδότες), πρέπει να συμβουλευθούν έναν ιατρό πριν πλησιάσουν κοντά σε εργασίες συγκόλλησης τόξου.

1.7.1 Ταξινόμηση ΗΜΣ σύμφωνα με το πρότυπο: EN 60974-10/A1:2015.

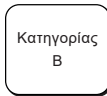

Η συσκευή κατηγορίας Β είναι κατασκευασμένη σε συμμόρφωση με τις απαιτήσεις συμβατότητας σε βιομηχανικούς χώρους ή κατοικίες, συμπεριλαμβανομένων των κατοικημένων περιοχών όπου η ηλεκτρική ενέργεια παρέχεται από κάποιο δημόσιο σύστημα χαμηλής τάσης.



Η συσκευή κατηγορίας Α δεν προορίζεται για χρήση σε κατοικημένες περιοχές όπου η ηλεκτρική ενέργεια παρέχεται από κάποιο δημόσιο σύστημα χαμηλής τάσης. Θα ήταν δυνητικά δύσκολο να εξασφαλιστεί η ηλεκτρομαγνητική συμβατότητα των συσκευών κατηγορίας Α σε αυτές τις περιοχές, εξαιτίας των παρεμβολών που εκπέμπονται και προσάγονται.

Δείτε το κεφάλαιο για περισσότερες πληροφορίες: ΠΙΝΑΚΪΔΑ ΧΑΡΑΚΤΗΡΙΣΤΙΚΩΝ ή ΤΕΧΝΙΚΑ ΧΑΡΑΚΤΗΡΙΣΤΙΚΑ.

1.7.2 Εγκατάσταση, χρήση και αξιολόγηση του χώρου

Η συσκευή αυτή κατασκευάζεται σύμφωνα με τις οδηγίες του εναρμονισμένου προτύπου EN 60974-10/A1:2015 και κατατάσσεται στην "ΚΑΤΗΓΟΡΙΑ Α". Η συσκευή πρέπει να προορίζεται μόνο για επαγγελματική χρήση, σε βιομηχανικό περιβάλλον. Ο κατασκευαστής δε φέρει καμία ευθύνη για βλάβες που ενδεχομένως προκληθούν εξαιτίας της χρήσης της διάταξης μέσα σε κατοικίες.



Ο χρήστης πρέπει να έχει εμπειρία στον τομέα αυτό και θεωρείται υπεύθυνος για την εγκατάσταση και τη χρήση της συσκευής, σύμφωνα με τις οδηγίες του κατασκευαστή. Αν παρατηρηθούν ηλεκτρομαγνητικές παρεμβολές, ο χρήστης πρέπει να λύσει το πρόβλημα με την τεχνική υποστήριξη του κατασκευαστή.



Σε όλες τις περιπτώσεις, οι ηλεκτρομαγνητικές παρεμβολές πρέπει να ελαττωθούν έως το βαθμό στον οποίο που δεν προκαλούν ενόχληση.



Πριν την εγκατάσταση της συσκευής, ο χρήστης πρέπει να εκτιμήσει τα πιθανά ηλεκτρομαγνητικά προβλήματα που θα μπορούσαν να παρουσιαστούν στη γύρω ζώνη και ιδιαίτερα στην υγεία των παρόντων. Για παράδειγμα: άτομα με βηματοδότη (pace-maker) και ακουστικά βαρηκοΐας.

1.7.3 Απαιτήσεις τροφοδοσίας (βλ. τεχνικά χαρακτηριστικά)

Οι συσκευές υψηλής ισχύος θα μπορούσαν να επηρεάσουν την ποιότητα της ενέργειας του δικτύου διανομής, εξαιτίας του απορροφούμενου ρεύματος. Συνεπώς, για μερικούς τύπους συσκευών (βλ. τεχνικά χαρακτηριστικά) θα μπορούσαν να υφίστανται κάποιοι περιορισμοί σύνδεσης ή μερικές απαιτήσεις που αφορούν την μέγιστη επιτρεπόμενη εμπέδηση δικτύου (Z_{max}) ή την ελάχιστη ισχύ εγκατάστασης (S_{sc}) που διατίθεται στο σημείο διεπαφής με το δίκτυο (Σημείο Κοινής σύνδεσης ΣΚΣ - Point of Common Coupling PCC). Στην περίπτωση αυτή, ο εγκαταστάτης ή ο χρήστης έχουν την υποχρέωση να εξακριβώσουν (συμβουλευόμενοι ενδεχομένως τον διαχειριστή του ηλεκτρικού δικτύου) αν η συσκευή μπορεί να συνδεθεί. Σε περίπτωση παρεμβολών, μπορεί να είναι αναγκαία η λήψη πρόσθετων μέτρων, όπως η τοποθέτηση φίλτρων στο δίκτυο τροφοδοσίας.

Πρέπει επίσης να εκτιμήσετε αν είναι σκόπιμο να θωρακιστεί το καλώδιο τροφοδοσίας.

Δείτε το κεφάλαιο για περισσότερες πληροφορίες: ΤΕΧΝΙΚΑ ΧΑΡΑΚΤΗΡΙΣΤΙΚΑ.

1.7.4 Προληπτικά μέτρα σχετικά με τα καλώδια

Για την ελαχιστοποίηση των επιπτώσεων από τα ηλεκτρομαγνητικά πεδία, ακολουθείτε τους εξής κανόνες:

- Τυλίγεται και στερεώνεται μαζί, όπου αυτό είναι δυνατό, το καλώδιο γείωσης με το καλώδιο ισχύος.
- Αποφεύγετε το τύλιγμα των καλωδίων γύρω από το σώμα.
- Μη στέκεστε μεταξύ καλωδίου γείωσης και καλωδίου ισχύος (τα δύο καλώδια πρέπει να βρίσκονται από την ίδια πλευρά).
- Τα καλώδια πρέπει να έχουν το μικρότερο δυνατό μήκος, να τοποθετούνται κοντά μεταξύ τους και να μετακινούνται πάνω ή κοντά στην επιφάνεια του δαπέδου.
- Τοποθετείτε την διάταξη σε κάποια απόσταση από το σημείο συγκόλλησης.
- Τα καλώδια πρέπει να είναι τοποθετημένα μακριά από ενδεχόμενα άλλα καλώδια.

1.7.5 Ισοδυναμική σύνδεση (γείωση)

Πρέπει να εκτιμήσετε αν είναι απαραίτητη η γείωση όλων των μεταλλικών εξαρτημάτων της εγκατάστασης συγκόλλησης και της γύρω περιοχής. Τηρήστε τους τοπικούς τεχνικούς κανονισμούς περί ισοδυναμικής σύνδεσης (γείωσης).

1.7.6 γείωση του κατεργαζόμενου κομματιού

Όπου το υπό επεξεργασία κομμάτι δεν είναι γειωμένο, για λόγους ηλεκτρικής ασφαλείας ή εξαιτίας των διαστάσεων και της θέσης του, η σύνδεση γείωσης μεταξύ τεμαχίου και εδάφους μπορεί να μειώσει τις εκπομπές. Απαιτείται προσοχή, ώστε η γείωση του κατεργαζόμενου κομματιού να μην αυξάνει τον κίνδυνο ατυχήματος για το χειριστή ή να προκαλεί βλάβες σε άλλες ηλεκτρικές συσκευές. Τηρήστε τους τοπικούς τεχνικούς κανονισμούς περί ισοδυναμικής σύνδεσης (γείωσης).

1.7.7 Θωράκιση

Η επιλεκτική θωράκιση άλλων καλωδίων και συσκευών στη γύρω περιοχή μπορεί να μειώσει τα προβλήματα παρεμβολών.

Σε ειδικές εφαρμογές, θα μπορούσε να ληφθεί υπόψη η θωράκιση όλης της διάταξης συγκόλλησης.

1.8 Βαθμός προστασίας IP



IP23S

- Περίβλημα που αποτρέπει την τυχαία πρόσβαση σε επικίνδυνα μέρη κάποιου δάχτυλου ή κάποιου ξένου σώματος με διάμετρο ίση ή μεγαλύτερη από 12,5 mm.
- Περίβλημα προστατευμένο από βροχή που πέφτει με γωνία 60°.
- Περίβλημα που αποτρέπει τις βλαβερές συνέπειες της εισόδου νερού, όταν τα κινούμενα μέρη της συσκευής είναι ακίνητα.

1.9 Διάθεση



Μην απορρίπτετε την ηλεκτρική συσκευή με τα κοινά απόβλητα!

Σύμφωνα με την Ευρωπαϊκή Οδηγία 2012/19/ΕΕ σχετικά με τα απόβλητα ηλεκτρικού και ηλεκτρονικού εξοπλισμού, και για την εφαρμογή της βάσει της εθνικής νομοθεσίας, ο ηλεκτρικός εξοπλισμός που φτάνει στο τέλος του κύκλου ζωής του, πρέπει να συλλέγεται χωριστά και να παραδίδεται σε κέντρο ανάκτησης και διάθεσης. Ο ιδιοκτήτης της συσκευής οφείλει να αναζητήσει τα εξουσιοδοτημένα κέντρα συλλογής απευθυνόμενος στις τοπικές αρχές. Η εφαρμογή της Ευρωπαϊκής Οδηγίας θα επιτρέψει την καλύτερη προστασία του περιβάλλοντος και της υγείας του ανθρώπου.

» Για περισσότερες πληροφορίες, επισκεφθείτε την ιστοσελίδα.

2. ΕΓΚΑΤΑΣΤΑΣΗ



Η εγκατάσταση μπορεί να γίνει μόνο από έμπειρο προσωπικό, εξουσιοδοτημένο από τον κατασκευαστή.



Πριν την εγκατάσταση, βεβαιωθείτε ότι η γεννήτρια είναι αποσυνδεδεμένη από το ηλεκτρικό δίκτυο.



Απαγορεύεται η σύνδεση των γεννητριών (σε σειρά ή παράλληλα).

2.1 Τρόπος ανύψωσης, μεταφοράς και εκφόρτωσης

- Η διάταξη διαθέτει μια χειρολαβή, που επιτρέπει τη μετακίνησή της με το χέρι.



Μην υποτιμάτε το βάρος της διάταξης (βλ. τεχνικά χαρακτηριστικά).

Κατά την ανύψωση, κανένα άτομο δεν πρέπει να βρίσκεται κάτω από το φορτίο.

Αποφύγετε την πτώση της διάταξης και μην την αποθέτετε με δύναμη στο δάπεδο.

2.2 Τοποθέτηση της διάταξης



Τηρήστε τους εξής κανόνες:

- Εύκολη πρόσβαση στα όργανα ελέγχου και τις συνδέσεις.
- Μην τοποθετείτε τον εξοπλισμό σε στενούς χώρους.
- Μην τοποθετείτε ποτέ τη διάταξη πάνω σε μια επιφάνεια με κλίση μεγαλύτερη από 10° ως προς το οριζόντιο επίπεδο.
- Τοποθετήστε τη διάταξη σε χώρο στεγνό, καθαρό και με επαρκή εξαερισμό.
- Προστατέψτε τη διάταξη από τη βροχή και τον ήλιο.

2.3 Σύνδεση



Η γεννήτρια διαθέτει ηλεκτρικό καλώδιο, για τη σύνδεση στο δίκτυο τροφοδοσίας.

Η διάταξη μπορεί να τροφοδοτηθεί με ρεύμα:

- 230V τριφασικό
- 400V τριφασικό

Η λειτουργία της συσκευής είναι εγγυημένη για τάσεις με διακυμάνσεις έως $\pm 15\%$ επί της ονομαστικής τιμής.



Για να αποφευχθούν ζημιές σε άτομα ή στην εγκατάσταση, πρέπει να ελέγξετε την επιλεγμένη τάση του δικτύου και τις ασφάλειες ΠΡΙΝ συνδέσετε το μηχάνημα στο ρεύμα. Επίσης πρέπει να βεβαιωθείτε ότι το καλώδιο είναι συνδεδεμένο σε μια πρίζα που διαθέτει γείωση.



Η εγκατάσταση μπορεί να τροφοδοτηθεί από ηλεκτροπαραγωγό ζεύγος αρκεί να εξασφαλίζει σταθερή τάση τροφοδοσίας μεταξύ $\pm 15\%$ ως προς την ονομαστική τιμή τάσης που δηλώνει ο κατασκευαστής σε όλες τις πιθανές συνθήκες χρήσης και με τη μέγιστη παρεχόμενη ισχύ της γεννήτριας. Κατά κανόνα, συνιστάται η χρήση ηλεκτροπαραγωγών ζευγών με ισχύ 2 φορές μεγαλύτερη από την ισχύ της γεννήτριας, για το μονοφασικό ρεύμα, και 1,5 φορά, για το τριφασικό. Συνιστάται η χρήση ηλεκτροπαραγωγών ζευγών με ηλεκτρονικό έλεγχο.



Για την προστασία των χειριστών, η διάταξη πρέπει να είναι σωστά γειωμένη. Το καλώδιο τροφοδοσίας διαθέτει έναν αγωγό (κίτρινοπράσινος) για τη γείωση, που πρέπει να συνδεθεί σε ένα φως με επαφή γείωσης. Ο κίτρινος/πράσινος αγωγός δεν πρέπει να χρησιμοποιείται ΠΟΤΕ μαζί με άλλο αγωγό για την παροχή τάσης. Ελέγξτε την ύπαρξη γείωσης στην εγκατάσταση και την καλή κατάσταση της πρίζας του ρεύματος. Χρησιμοποιείτε μόνο φως που τηρούν τους κανονισμούς ασφαλείας.



Η ηλεκτρική εγκατάσταση πρέπει να γίνει από διπλωματούχο ηλεκτρολόγο και σύμφωνα με τους νόμους της χώρας όπου γίνεται η εγκατάσταση.

2.4 θέση σε λειτουργία

2.4.1 Σύνδεση για συγκόλληση MMA



Η σύνδεση που απεικονίζεται έχει σαν αποτέλεσμα συγκόλληση με ανάστροφη πολικότητα. Για να εκτελέσετε μία συγκόλληση με κανονική (άμεση) πολικότητα, αντιστρέψτε τη σύνδεση.

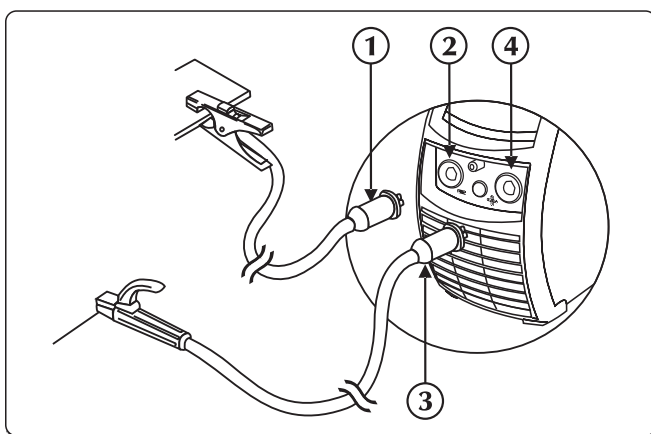



- ① Βύσμα τσιμπίδας γείωσης
- ② αρνητική υποδοχή ισχύος (-)
- ③ Βύσμα τσιμπίδας ηλεκτροδίου
- ④ θετική υποδοχή ισχύος (+)

- ▶ Συνδέστε το βύσμα του καλωδίου της τσιμπίδας σώματος στην αρνητική υποδοχή (-) της γεννήτριας. Βάλτε το βύσμα και γυρίστε δεξιόστροφα, έως ότου ασφαλίσουν τα δύο μέρη.
- ▶ Συνδέστε το βύσμα του καλωδίου της τσιμπίδας ηλεκτροδίου στην θετική υποδοχή (+) της γεννήτριας. Βάλτε το βύσμα και γυρίστε δεξιόστροφα, έως ότου ασφαλίσουν τα δύο μέρη.

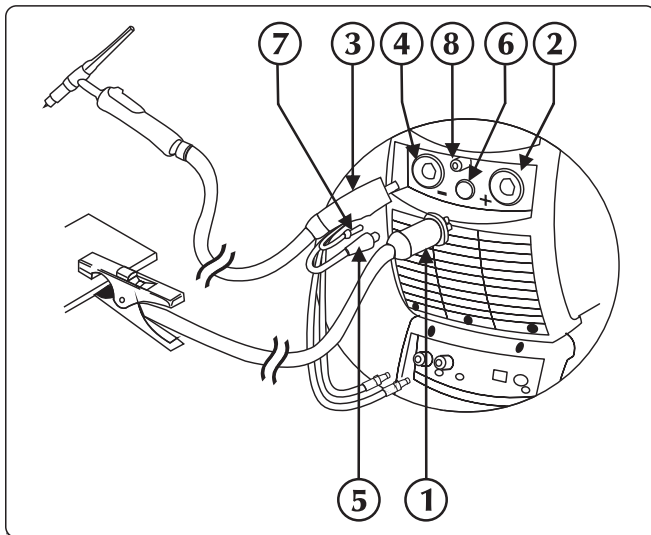
2.4.2 Σύνδεση για συγκόλληση TIG



- ① Βύσμα τσιμπίδας γείωσης
- ② θετική υποδοχή ισχύος (+)
- ③ TTIG υποδοχή σύνδεσης τσιμπίδας
- ④ Υποδοχή φακού
- ⑤ Καλώδιο σήματος της τσιμπίδας
- ⑥ Συνδετήρας
- ⑦ Σωλήνας αερίου φακού
- ⑧ Αερίου ρακόρ/σύνδεσμο

- ▶ Συνδέστε το βύσμα του καλωδίου της τσιμπίδας του σώματος στην θετική υποδοχή (+) της γεννήτριας. Βάλτε το βύσμα και γυρίστε δεξιόστροφα, έως ότου ασφαλίσουν τα δύο μέρη.
- ▶ Συνδέστε το βύσμα της τσιμπίδας TIG στις υποδοχή τσιμπίδας της γεννήτριας. Βάλτε το βύσμα και γυρίστε δεξιόστροφα, έως ότου ασφαλίσουν τα δύο μέρη.
- ▶ Συνδέστε το καλώδιο σήματος της τσιμπίδας, στο ειδικό βύσμα σύνδεσης.
- ▶ Συνδέστε το σωλήνα αερίου της τσιμπίδας στον ειδικό ρακόρ/σύνδεσμο.
- ▶ Συνδέστε το σωλήνα επιστροφής ψυκτικού υγρού της τσιμπίδας (κόκκινου χρώματος), στο ειδικό ρακόρ/σύνδεσμο (κόκκινου χρώματος - σύμβολο )
- ▶ Συνδέστε το σωλήνα προσαγωγής ψυκτικού υγρού της τσιμπίδας (μπλε χρώματος), στο ειδικό ρακόρ/σύνδεσμο (μπλε χρώματος - σύμβολο )

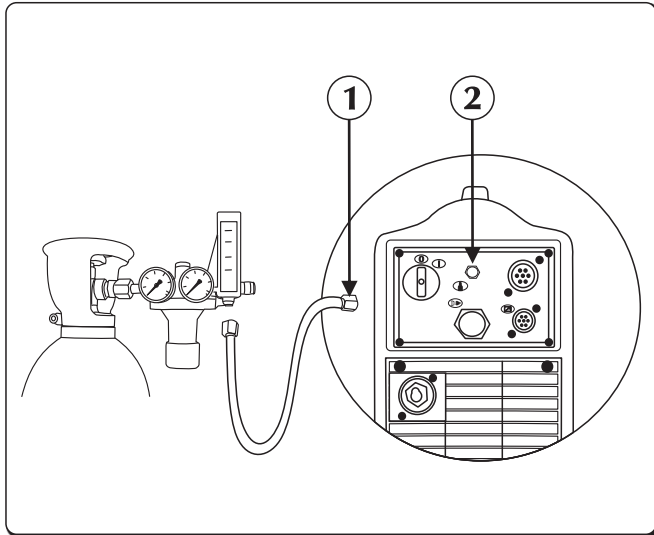

- ① Σωλήνας αερίου
- ② Αερίου ρακόρ/σύνδεσμο

► Συνδέστε το σωλήνα αερίου που προέρχεται από τη φιάλη στο πίσω ρακόρ αερίου. Ρυθμίστε τη ροή αερίου από 5 έως 15 λίτρα/λεπτό.

3. ΠΑΡΟΥΣΙΑΣΗ ΤΗΣ ΔΙΑΤΑΞΗΣ

3.1 Πίσω πάνελ

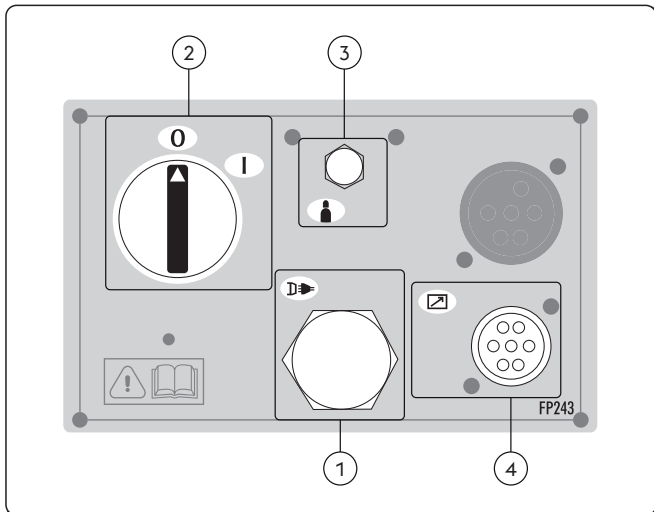

- ① καλώδιο τροφοδοσίας
Επιτρέπει την παροχή ρεύματος στη συσκευή, συνδέοντάς το με το δίκτυο.
- ② Διακόπτης ανάμματος
Ελέγχει την ηλεκτρική ενεργοποίηση της εγκατάστασης. Διαθέτει δύο θέσεις: "0" σβηστό, "I" αναμμένο.
- ③ Σύνδεση αερίου
- ④ Είσοδος καλωδίου σήματος CAN-BUS (RC, RI...)



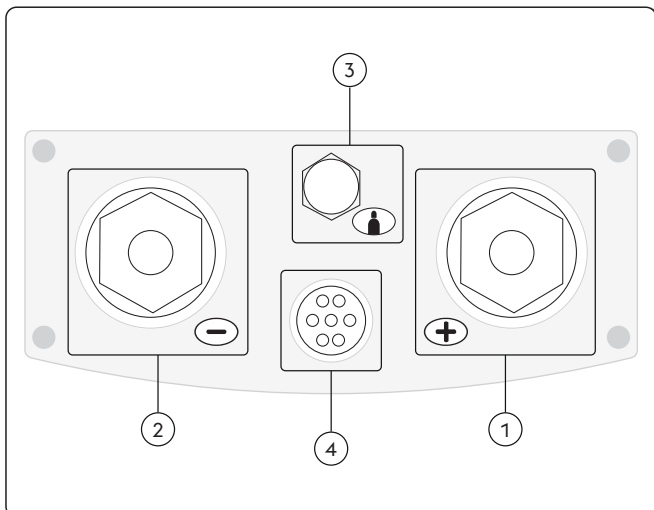



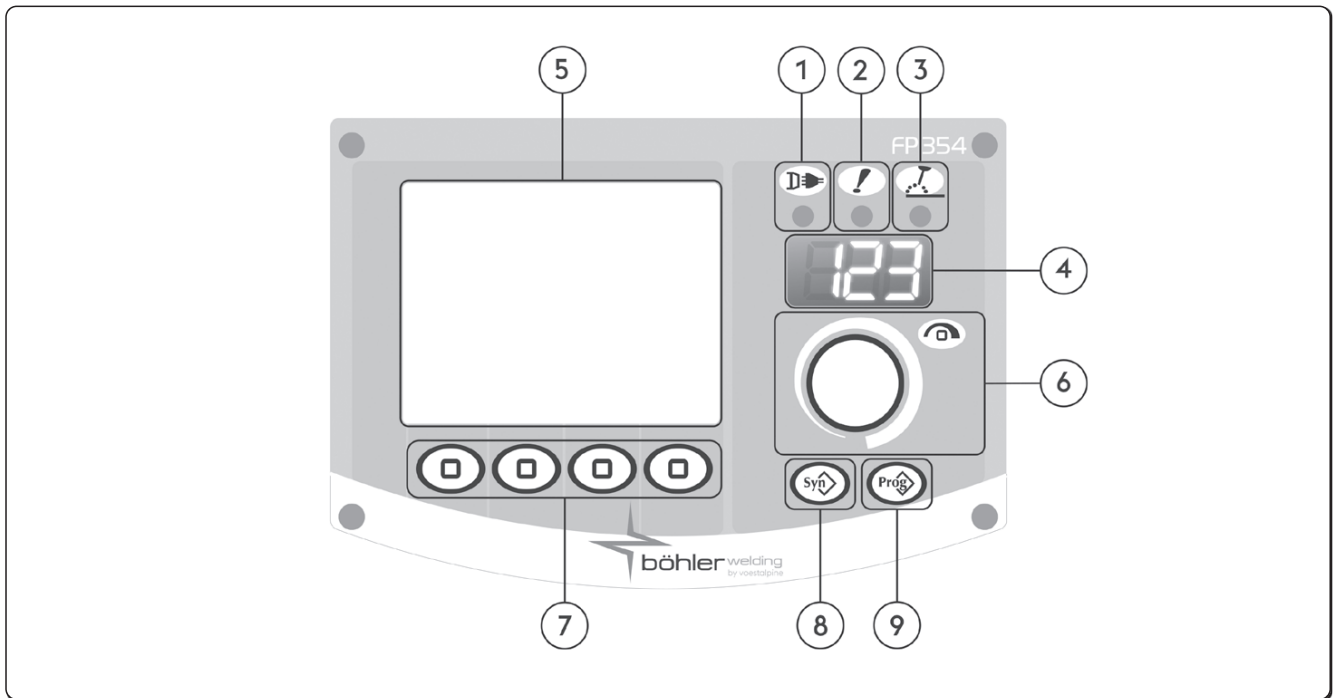

3.2 Πίνακας υποδοχών



- ① θετική υποδοχή ισχύος (+)
Διαδικασία MMA: Σύνδεση φακό ηλεκτροδίου
Διαδικασία TIG: Σύνδεση καλωδίου γείωσης
- ② αρνητική υποδοχή ισχύος (-)
Διαδικασία MMA: Σύνδεση καλωδίου γείωσης
Διαδικασία TIG: Σύνδεση τσιμπίδας
- ③ Σύνδεση αερίου
- ④ Είσοδος καλωδίου σήματος (Τσιμπίδα TIG)

3.3 Μπροστινός πίνακας ελέγχου



- 1  **LED τροφοδοσίας**
Υποδεικνύει ότι η διάταξη είναι συνδεδεμένη με το δίκτυο και τροφοδοτείται κανονικά.
- 2  **LED γενικού συναγερμού**
Υποδεικνύει ότι επενέβη κάποια διάταξη ασφαλείας (π.χ., θερμικό).
- 3  **LED ενεργοποιημένης ισχύος**
Υποδεικνύει την παρουσία τάσης στις υποδοχές εξόδου της διάταξης.
- 4  **Οθόνη 7 τμημάτων**
Επιτρέπει την εμφάνιση των γενικών στοιχείων την μηχανής συγκόλλησης, κατά την εκκίνηση, τις ρυθμίσεις και τις καταγραφόμενες τιμές του ρεύματος και της τάσης, κατά τη συγκόλληση, καθώς και τους κωδικούς συναγερμού.
- 5  **Οθόνη (LCD)**
Επιτρέπει την εμφάνιση των γενικών στοιχείων την μηχανής συγκόλλησης, κατά την εκκίνηση, τις ρυθμίσεις και τις καταγραφόμενες τιμές του ρεύματος και της τάσης, κατά τη συγκόλληση, καθώς και τους κωδικούς συναγερμού. Επιτρέπει την άμεση εμφάνιση όλων των λειτουργιών.
- 6  **Κύριος διακόπτης ρύθμισης**
Επιτρέπει την αδιάλειπτη τροφοδοσία του ρεύματος συγκόλλησης.
Επιτρέπει την είσοδο στο set up, την επιλογή και τη ρύθμιση των παραμέτρων συγκόλλησης.
- 7  **Πλήκτρα λειτουργίας**
Επιτρέπουν την επιλογή των διαφόρων λειτουργιών της διάταξης:
- Διαδικασία συγκόλλησης
- Τρόπος συγκόλλησης
- Παλμικότητα ρεύματος
- Γραφική απεικόνιση
- 8  **Μη χρησιμοποιούμενο πλήκτρο**
- 9  **Πλήκτρο job**
Επιτρέπει την αποθήκευση στη μνήμη και τη διαχείριση 240 job, τα οποία μπορούν να εξατομικευτούν από τον χειριστή.

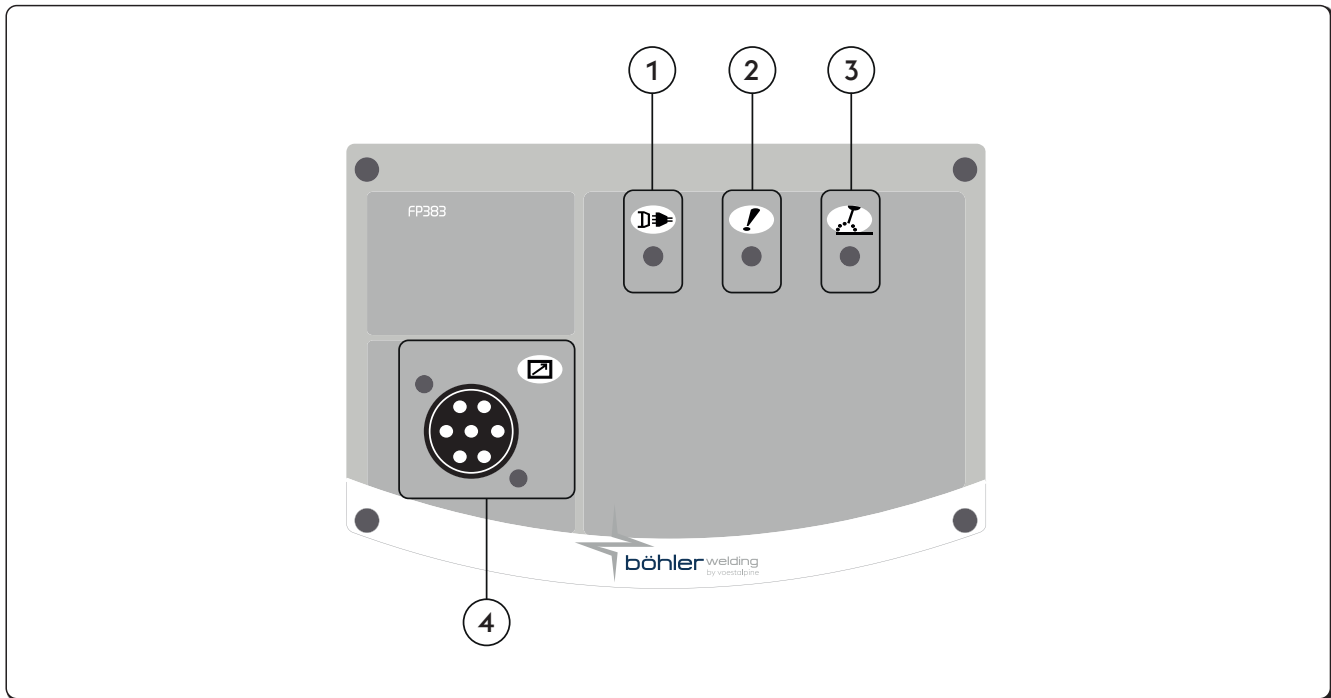

- 1 **LED τροφοδοσίας**
Υποδεικνύει ότι η διάταξη είναι συνδεδεμένη με το δίκτυο και τροφοδοτείται κανονικά.
- 2 **LED γενικού συναγερμού**
Υποδεικνύει ότι επενέβη κάποια διάταξη ασφαλείας (π.χ., θερμικό).
- 3 **LED ενεργοποιημένης ισχύος**
Υποδεικνύει την παρουσία τάσης στις υποδοχές εξόδου της διάταξης.
- 4 **Είσοδος καλωδίου σήματος CAN-BUS (RC, RI...)**

4. ΧΡΗΣΗ ΤΟΥ ΕΞΟΠΛΙΣΜΟΥ

4.1 Σελίδα εκκίνησης

Κατά την εκκίνηση, η εγκατάσταση εκτελεί μια σειρά ελέγχων που διασφαλίζουν τη σωστή λειτουργία της εγκατάστασης και όλων των συνδεδεμένων διατάξεων. Κατά το στάδιο αυτό πραγματοποιείται και το τεστ αερίου, για να διαπιστωθεί η σωστή σύνδεση του συστήματος τροφοδοσίας αερίου.

4.2 Αρχική σελίδα

Επιτρέπει τη διαχείριση της διάταξης και του τρόπου συγκόλλησης, με την εμφάνιση των βασικών ρυθμίσεων.

4.3 Κεντρική οθόνη διαδικασίας MMA

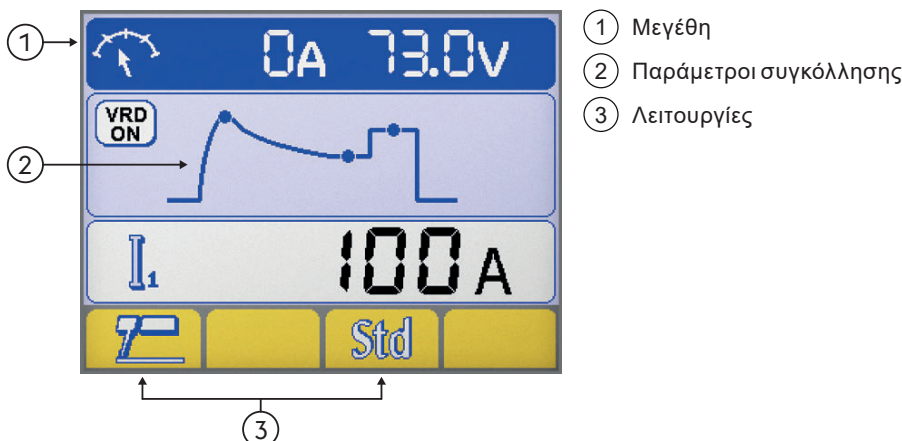

Μεγέθη

Κατά τα στάδια της συγκόλλησης, στην οθόνη LCD εμφανίζονται οι πραγματικές τιμές τάσης και ρεύματος.



- ① Ρεύμα συγκόλλησης
- ② Τάση συγκόλλησης

Παράμετροι συγκόλλησης

► Επιλέξτε την παράμετρο που θέλετε, πατώντας το πλήκτρο encoder.

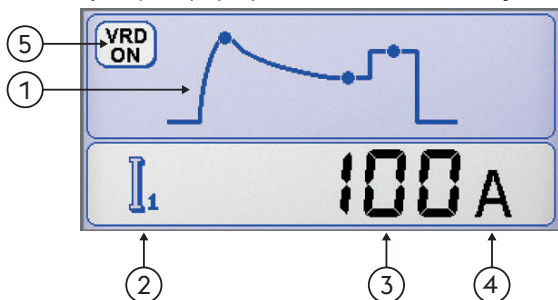

- ① Παράμετροι συγκόλλησης
- ② Εικονίδιο παραμέτρου
- ③ Τιμή παραμέτρου
- ④ Μονάδα μέτρησης παραμέτρου
- ⑤ VRD (Voltage Reduction Device)
Διάταξη μείωσης τάσης
Επισημαίνει ότι η τάση εν κενώ της διάταξης είναι υπό έλεγχο.

Λειτουργίες

Επιτρέπουν τη ρύθμιση της λειτουργικότητας των πιο σημαντικών τρόπων συγκόλλησης.



- ① Διαδικασία συγκόλλησης
- ② Συνεργία MMA

Διαδικασία συγκόλλησης



MMA



TIG DC

Συνεργία MMA



Επιτρέπει τη ρύθμιση της καλύτερης δυναμικής τόξου, επιλέγοντας τον τύπο του χρησιμοποιούμενου ηλεκτροδίου. Η επιλογή της σωστής δυναμικής τόξου επιτρέπει την πλήρη εκμετάλλευση των δυνατοτήτων της διάταξης και την επίτευξη της καλύτερης δυνατής απόδοσης στη συγκόλληση.



Standard
(Βασικό/Ρουτιλίου)



Κυτταρίνης



Χάλυβα



Αλουμινίου



Χυτοσιδήρου



Δεν εξασφαλίζεται η τέλεια συγκολλητότητα του χρησιμοποιούμενου ηλεκτροδίου.

Η συγκολλητότητα εξαρτάται από την ποιότητα των αναλώσιμων υλικών και από τον τρόπο αποθήκευσης/φύλαξής τους, από τις συνθήκες εργασίας και συγκόλλησης, από τις πολυάριθμες δυνατές εφαρμογές, κτλ.

4.4 Κεντρική οθόνη διαδικασίας TIG

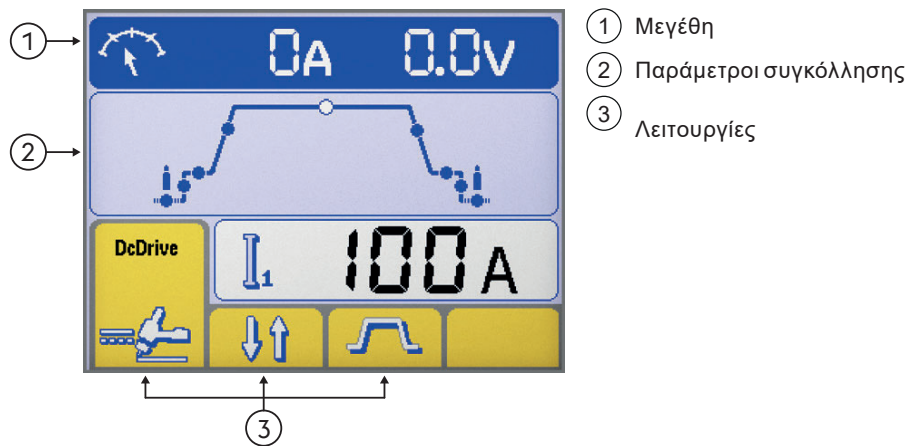

Μεγέθη

Κατά τα στάδια της συγκόλλησης, στην οθόνη LCD εμφανίζονται οι πραγματικές τιμές τάσης και ρεύματος.

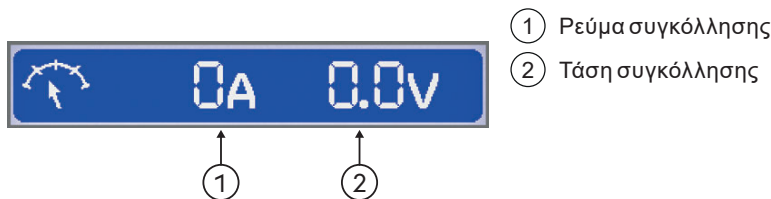

Παράμετροι συγκόλλησης

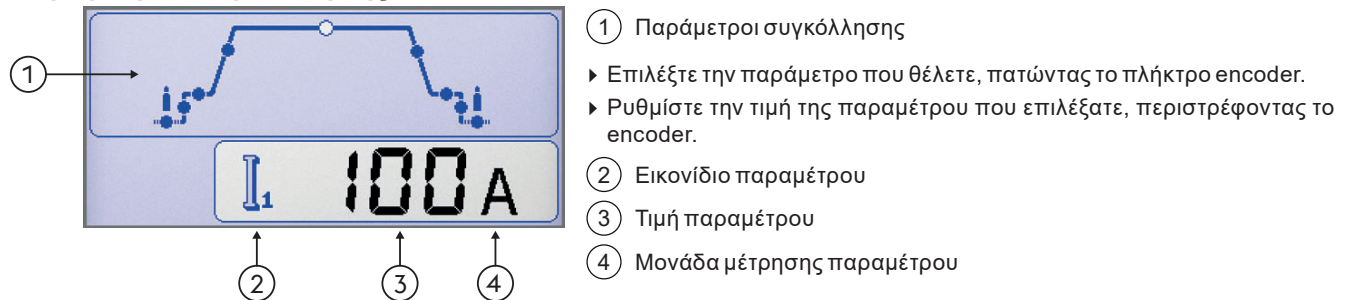

Λειτουργίες

Επιτρέπουν τη ρύθμιση της λειτουργικότητας των πιο σημαντικών τρόπων συγκόλλησης.

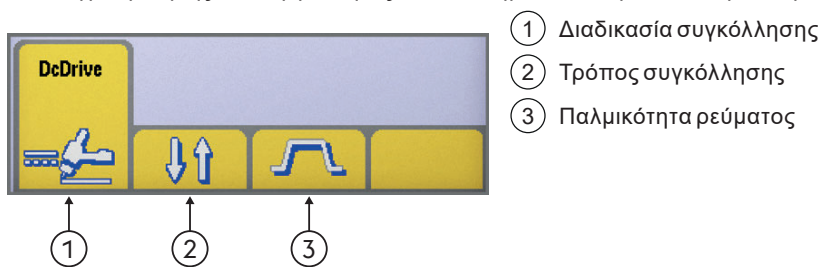

Διαδικασία συγκόλλησης

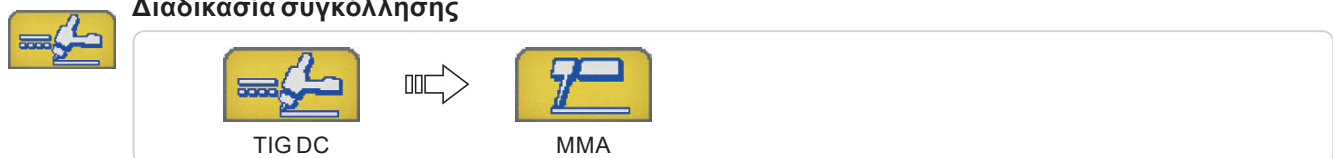

Τρόπος συγκόλλησης

Επιτρέπει την επιλογή του τρόπου συγκόλλησης



2 Χρόνοι

Κατά τον τρόπο "2 Χρόνοι", το πάτημα του πλήκτρου προκαλεί τη ροή του αερίου και το άναμμα του τόξου. Μόλις αφηθεί το πλήκτρο, το ρεύμα μηδενίζεται εντός του χρόνου σταδιακής καθόδου. Μόλις σβήσει το τόξο, το αέριο ρέει για τον προκαθορισμένο χρόνο post-gas.



4 Χρόνοι

Κατά τον τρόπο “4 Χρόνοι”, το πρώτο πάτημα του πλήκτρου προκαλεί τη ροή του αερίου, πραγματοποιώντας ένα χειροκίνητο pre-gas. Μόλις αφηθεί, ανάβει το τόξο.



Bilevel

Με διπλή ρύθμιση, ο συγκολλητής μπορεί να πραγματοποιεί συγκολλήσεις με δύο διαφορετικά προεπιλεγμένα ρεύματα. Με το πρώτο πάτημα του κουμπιού της τσιμπίδας ενεργοποιείται το pre-gas, το άναμμα του τόξου και η συγκόλληση με αρχικό ρεύμα. Με την πρώτη απελευθέρωση πραγματοποιείται η σταδιακή άνοδος έως το ρεύμα “I1”. Αν ο συγκολλητής πατήσει και αφήσει γρήγορα το πλήκτρο, πραγματοποιείται η μετάβαση στο “I2”. Ξαναπατώντας και απελευθερώνοντας γρήγορα το πλήκτρο επιστρέφει το “I1”, κ.ο.κ. Πατώντας για περισσότερο χρόνο αρχίζει η ράμπα καθόδου του ρεύματος που οδηγεί στο τελικό ρεύμα. Αφήνοντας το πλήκτρο επιτυγχάνεται το σβήσιμο του τόξου, ενώ το αέριο συνεχίζει να ρέει για τον προκαθορισμένο χρόνο post-gas.



Παλμικότητα ρεύματος



Ρεύμα σταθερό



Ρεύμα παλμικό



Fast Pulse



EasyArc

4.5 Σελίδα προγραμμάτων



Επιτρέπει την αποθήκευση στη μνήμη και τη διαχείριση 240 job, τα οποία μπορούν να εξατομικευτούν από τον χειριστή.

Προγράμματα (JOB)

βλ. παράγραφο “Αρχική σελίδα”

Αποθήκευση προγράμματος στη μνήμη

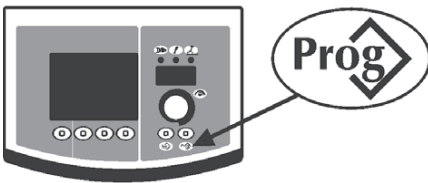

- ▶ Μπείτε στη σελίδα “αποθήκευση προγράμματος στη μνήμη”, πατώντας το πλήκτρο τουλάχιστον επί ένα δευτερόλεπτο.



- ▶ έξτε το πρόγραμμα (ή την κενή θέση μνήμης) που θέλετε, περιστρέφοντας το encoder.

--- Κενή θέση μνήμης



Πρόγραμμα αποθηκευμένο

- ▶ Επιβεβαιώστε την ενέργεια, πατώντας το πλήκτρο .
- ▶ Αποθηκεύστε όλες τις τρέχουσες ρυθμίσεις μέσα στο επιλεγμένο πρόγραμμα, πατώντας το πλήκτρο .

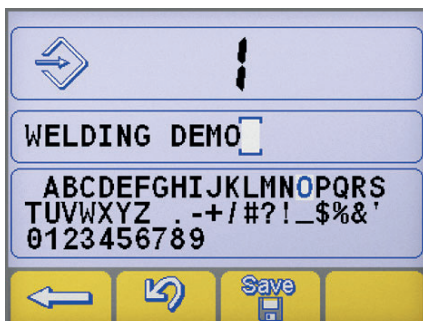

Εισάγετε μία περιγραφή του προγράμματος.

- ▶ Επιλέξτε το γράμμα που θέλετε, περιστρέφοντας το encoder.
- ▶ Αποθηκεύστε το γράμμα που θέλετε, πατώντας το encoder.
- ▶ Διαγράψτε το τελευταίο γράμμα, πατώντας το πλήκτρο .
- ▶ Επιβεβαιώστε την ενέργεια, πατώντας το πλήκτρο .
- ▶ Επιβεβαιώστε την ενέργεια, πατώντας το πλήκτρο .



Όταν αποθηκεύεται ένα νέο πρόγραμμα σε μία ήδη κατειλημμένη θέση μνήμης, η μνήμη διαγράφεται μέσω μιας συγκεκριμένης διαδικασίας.



- ▶ Επιβεβαιώστε την ενέργεια, πατώντας το πλήκτρο
- ▶ Διαγράψτε το πρόγραμμα που επιλέξατε, πατώντας το πλήκτρο
- ▶ Συνεχίστε τη διαδικασία αποθήκευσης στη μνήμη.

Ανοιγμα προγραμμάτων

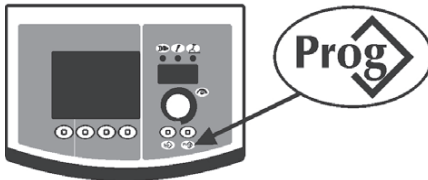

- ▶ Ανοίξτε το 1° διαθέσιμο πρόγραμμα, πατώντας το πλήκτρο, πατώντας το πλήκτρο
- ▶ Επιλέξτε το πρόγραμμα που θέλετε, περιστρέφοντας το encoder.
- ▶ Επιλέξτε το επιθυμητό πρόγραμμα, πατώντας το πλήκτρο
- Εμφανίζονται μόνο οι θέσεις μνήμης που περιέχουν κάποιο πρόγραμμα (οι κενές θέσεις παραλείπονται αυτόματα).

Διαγραφή προγραμμάτων



- ▶ Επιλέξτε το πρόγραμμα που θέλετε, περιστρέφοντας το encoder.
- ▶ Διαγράψτε το πρόγραμμα που επιλέξατε, πατώντας το πλήκτρο
- ▶ Επιβεβαιώστε την ενέργεια, πατώντας το πλήκτρο



- ▶ Επιβεβαιώστε την ενέργεια, πατώντας το πλήκτρο
- ▶ Διαγράψτε το πρόγραμμα που επιλέξατε, πατώντας το πλήκτρο

5. SETUP

5.1 Set up και τη ρύθμιση των παραμέτρων

Επιτρέπει τον προγραμματισμό και τη ρύθμιση μιας σειράς πρόσθετων παραμέτρων, για καλύτερη και ακριβέστερη διαχείριση της διάταξης συγκόλλησης.

Οι παράμετροι που εμφανίζονται στο set up είναι οργανωμένες ως προς την επιλεγμένη διαδικασία συγκόλλησης και διαθέτουν αριθμητική κωδικοποίηση.

Είσοδος στο set up



- ▶ Επιτυγχάνεται πατώντας για 5 δευτερόλεπτα το πλήκτρο encoder.
- ▶ Η είσοδος επιβεβαιώνεται από την ένδειξη 0 στην οθόνη.

Επιλογή και ρύθμιση της επιθυμητής παραμέτρου

- ▶ Γυρίστε το encoder, έως ότου εμφανιστεί ο αριθμητικός κωδικός της επιθυμητής παραμέτρου.
- ▶ Στο σημείο αυτό, με το πάτημα του πλήκτρου encoder, εμφανίζεται η προγραμματισμένη τιμή και η ρύθμιση της επιλεγμένης παραμέτρου.

Έξοδος από το set up

- ▶ Για να βγείτε από τις “ρυθμίσεις”, πατήστε πάλι το πλήκτρο encoder.
- ▶ Για έξοδο από το set up επιλέξτε την παράμετρο “0” (αποθήκευση και έξοδος) και πατήστε το πλήκτρο encoder.
- ▶ Επιβεβαιώστε την ενέργεια, πατώντας το πλήκτρο .
- ▶ Για αποθήκευση της τροποποίησης και έξοδο από το set up πιέστε το κουμπί: .

5.1.1 Κατάλογος παραμέτρων set up (MMA)

0

Αποθήκευση και έξοδος

Επιτρέπει την αποθήκευση των αλλαγών και την έξοδο από το set up.

1

Επαναφέρω

Επιτρέπει την επαναφορά όλων των παραμέτρων στις προκαθορισμένες τιμές (default).

3

Hot start

Επιτρέπει τη ρύθμιση της τιμής hot start σε MMA.

Επιτρέπει την επιλογή περισσότερο ή λιγότερο “θερμής” εκκίνησης στις φάσεις έναυσης του τόξου, διευκολύνοντας τη διαδικασία εκκίνησης (start).



Ηλεκτρόδιο βασικό

Ελάχιστη	Μέγιστη	Προκαθορισμ
0/μακριά από	500%	80%

Ηλεκτρόδιο κυτταρίνης

Ελάχιστη	Μέγιστη	Προκαθορισμ
0/μακριά από	500%	150%

Ηλεκτρόδιο CrNi

Ελάχιστη	Μέγιστη	Προκαθορισμ
0/μακριά από	500%	100%

Ηλεκτρόδιο αλουμινίου

Ελάχιστη	Μέγιστη	Προκαθορισμ
0/μακριά από	500%	120%

Ηλεκτρόδιο χυτοσιδήρου

Ελάχιστη	Μέγιστη	Προκαθορισμ
0/μακριά από	500%	100%

Rutile ηλεκτρόδιο

Ελάχιστη	Μέγιστη	Προκαθορισμ
0/μακριά από	500%	80%

7

Ρεύμα συγκόλλησης

Επιτρέπει τη ρύθμιση του ρεύματος συγκόλλησης.



Ελάχιστη	Μέγιστη	Προκαθορισμ
3 A	I _{max}	100 A

8

Arc force

Επιτρέπει τη ρύθμιση της τιμής Arc force σε MMA.

Επιτρέπει την επιλογή περισσότερο ή λιγότερο έντονης δυναμικής απόκρισης στη συγκόλληση, διευκολύνοντας τις εργασίες του συγκολλητή.

Αυξήστε την τιμή του Arc force για να ελαττωθούν οι πιθανότητες να κολλήσει το ηλεκτρόδιο.

Ηλεκτρόδιο βασικό

Ελάχιστη	Μέγιστη	Προκαθορισμ
0/μακριά από	500%	30%

Ηλεκτρόδιο κυτταρίνης

Ελάχιστη	Μέγιστη	Προκαθορισμ
0/μακριά από	500%	350%

Ηλεκτρόδιο CrNi

Ελάχιστη	Μέγιστη	Προκαθορισμ
0/μακριά από	500%	30%

Ηλεκτρόδιο αλουμινίου

Ελάχιστη	Μέγιστη	Προκαθορισμ
0/μακριά από	500%	100%

Ηλεκτρόδιο χυτοσιδήρου

Ελάχιστη	Μέγιστη	Προκαθορισμ
0/μακριά από	500%	70%

Rutile ηλεκτρόδιο

Ελάχιστη	Μέγιστη	Προκαθορισμ
0/μακριά από	500%	80%

204 Dynamic power control (DPC)



Επιτρέπει την επιλογή του επιθυμητού χαρακτηριστικού V/I.

I=C Ρεύμα σταθερό

Η αύξηση του ύψους του τόξου δεν επηρεάζει καθόλου το παρεχόμενο ρεύμα συγκόλλησης.

Συνιστάται για ηλεκτρόδιο: Βασικό, Ρουτιλίου, Όξινη, Χάλυβα, Χυτοσιδήρου

1÷20 Πτωτικό χαρακτηριστικό με ρύθμιση σταδιακής καθόδου (ράμπας)

Η αύξηση του ύψους του τόξου προκαλεί τη μείωση του ρεύματος συγκόλλησης (και αντίστροφα), ανάλογα με την τιμή ρύθμισης, από 1 έως 20 Ampere, ανά Volt.

Συνιστάται για ηλεκτρόδιο: Κυτταρίνης, Αλουμινίου

P=C Σταθερή ισχύς

Η αύξηση του ύψους του τόξου προκαλεί την μείωση του ρεύματος συγκόλλησης (και αντίστροφα), με βάση τον κανόνα: $V \cdot I = K$

Συνιστάται για ηλεκτρόδιο: Κυτταρίνης, Αλουμινίου

312



Τάση βεβιασμένου σβησίματος τόξου

Επιτρέπει τον προγραμματισμό της τιμής τάσης στην οποία σβήνει βεβιασμένα το ηλεκτρικό τόξο.

Επιτρέπει την καλύτερη διαχείριση των διαφόρων συνθηκών λειτουργίας που παρουσιάζονται.

Για παράδειγμα, κατά το ποντάρισμα (σημειακή συγκόλληση), η χαμηλή τάση βεβιασμένου σβησίματος τόξου επιτρέπει μικρότερη φλόγα κατά την απομάκρυνση του ηλεκτροδίου από το κομμάτι, μειώνοντας τα πισιλίσματα, τα καψίματα και την οξειδωση του τεμαχίου.



Μην επιλέγετε ποτέ μία τάση βεβιασμένου σβησίματος τόξου μεγαλύτερη από την τάση εν κενώ της γεννήτριας.

Ηλεκτρόδιο βασικό

Ελάχιστη	Μέγιστη	Προκαθορισμ
0/μακριά από	Vmax	57.0 V

Ηλεκτρόδιο κυτταρίνης

Ελάχιστη	Μέγιστη	Προκαθορισμ
0/μακριά από	Vmax	70.0 V

399



Ταχύτητα μετατόπισης

Επιτρέπει τη ρύθμιση της ταχύτητας εκτέλεσης της συγκόλλησης.

Default cm/min: ταχύτητα αναφοράς για τη χειροκίνητη συγκόλληση.

Syn: Sinergic αξία.

Ελάχιστη	Μέγιστη	Προκαθορισμ
2 cm/min	200 cm/min	15 cm/min

500



Προγραμματισμός μηχανήματος

Επιτρέπει την επιλογή της επιθυμητής γραφικής διεπαφής.

Επιτρέπει την πρόσβαση στα ανώτερα επίπεδα του set up.

βλ. παράγραφο "Εξατομίκευση οθόνης (Set up 500)"

Τιμή	Επιλεγμένο επίπεδο
USER	Χρήστης
SERV	Service
vaBW	vaBW

Τιμή	Διεπαφή Χρήστη
XE	Τρόπος Easy
XA	Τρόπος Advanced
XP	Τρόπος Professional

551



Lock/unlock

Επιτρέπει το μπλοκάρισμα των οργάνων ελέγχου και την εισαγωγή ενός κωδικού ασφαλείας.

βλ. παράγραφο "Lock/unlock (Set up 551)".

552



Τόνος βομβητή

Επιτρέπει την επιλογή τόνου του βομβητή.

Ελάχιστη	Μέγιστη	Προκαθορισμ
0/μακριά από	10	10

601



Βήμα ρύθμισης

Επιτρέπει τη ρύθμιση μιας παραμέτρου, με βήμα που μπορεί να επιλεγεί από το χρήστη.

Ελάχιστη	Μέγιστη	Προκαθορισμ
1	Imax	1

602



Εξωτερική παράμετρος 2

Επιτρέπει τη διαχείριση της εξωτερικής παραμέτρου 2 (ελάχιστη τιμή, μέγιστη τιμή, προκαθορισμένη τιμή, επιλεγμένη παράμετρος).

705 Διακρίβωση αντίστασης κυκλώματος

Επιτρέπει τη βαθμονόμηση της εγκατάστασης.

βλ. παράγραφο "Διακρίβωση αντίστασης κυκλώματος (set up 705)".

751 Καταγραφή ρεύματος

Επιτρέπει την εμφάνιση της πραγματικής τιμής του ρεύματος συγκόλλησης.

752 Καταγραφή τάσης

Επιτρέπει την εμφάνιση της πραγματικής τιμής της τάσης συγκόλλησης.

768 Μέτρηση θερμικής παροχής HI

Επιτρέπει την εμφάνιση της τιμής μέτρησης της θερμικής παροχής σε συγκόλληση.

5.1.2 Κατάλογος παραμέτρων στο set up (TIG)
0 Αποθήκευση και έξοδος

Επιτρέπει την αποθήκευση των αλλαγών και την έξοδο από το set up.

1 Επαναφέρω

Επιτρέπει την επαναφορά όλων των παραμέτρων στις προκαθορισμένες τιμές (default).

2 Pre gas

Επιτρέπει τον προγραμματισμό και τη ρύθμιση της ροής αερίου πριν την έναυση του τόξου.

Επιτρέπει την αποστολή αερίου στην τσιμπίδα και την προετοιμασία του περιβάλλοντος για τη συγκόλληση.

Ελάχιστη	Μέγιστη	Προκαθορισμ
0/μακριά από	99.9 s	0.1 s

3 Αρχικό ρεύμα

Επιτρέπει τη ρύθμιση του ρεύματος έναρξης συγκόλλησης.

Επιτρέπει τη δημιουργία ενός θερμότερου ή ψυχρότερου λουτρού συγκόλλησης, κατά τα στάδια ακριβώς μετά την έναυση.

Ελάχιστη	Μέγιστη	Προκαθορισμ	Ελάχιστη	Μέγιστη	Προκαθορισμ
1%	200%	50%	3 A	I _{max}	-

5 Χρόνος αρχικού ρεύματος



Επιτρέπει τον καθορισμό της χρονικής διάρκειας διατήρησης του αρχικού ρεύματος.

Ελάχιστη	Μέγιστη	Προκαθορισμ
0/μακριά από	99.9 s	0/μακριά από

6 Σταδιακή άνοδος

Επιτρέπει τη σταδιακή μετάβαση, από το αρχικό ρεύμα, στο ρεύμα συγκόλλησης.

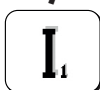
Ελάχιστη	Μέγιστη	Προκαθορισμ
0/μακριά από	99.9 s	0/μακριά από

7 Ρεύμα συγκόλλησης

Επιτρέπει τη ρύθμιση του ρεύματος συγκόλλησης.

Ελάχιστη	Μέγιστη	Προκαθορισμ
3 A	I _{max}	100 A

8 Ρεύμα bilevel



Επιτρέπει τη ρύθμιση του δευτερεύοντος ρεύματος, στη λειτουργία συγκόλλησης bilevel.

Επιτρέπει τη ρύθμιση του δευτερεύοντος ρεύματος, στη λειτουργία συγκόλλησης bilevel.

Με το πρώτο πάτημα του κουμπιού της τσιμπίδας έχουμε το pre-gas, την έναυση του τόξου και τη συγκόλληση με αρχικό ρεύμα. Αφήνοντας το κουμπί για πρώτη φορά έχουμε τη ράμπα ανόδου στο ρεύμα "I1".

Αν ο συγκολλητής πατάει και αφήνει γρήγορα το κουμπί περνάει στο "I2".

Πατώντας και αφήνοντας γρήγορα το κουμπί περνάει ξανά στο "I1" κ.ο.κ.

Πατώντας για περισσότερο χρόνο αρχίζει η ράμπα καθόδου του ρεύματος που οδηγεί στο τελικό ρεύμα.

Αφήνοντας το κουμπί το τόξο σβήνει ενώ το αέριο συνεχίζει να ρέει για το χρόνο post-gas.

Ελάχιστη	Μέγιστη	Προκαθορισμ	Ελάχιστη	Μέγιστη	Προκαθορισμ
3 A	I _{max}	-	1%	500%	μακριά από

10 Ρεύμα βάσης



Επιτρέπει τη ρύθμιση του ρεύματος βάσης σε παλμική λειτουργία και fast pulse.

Ελάχιστη	Μέγιστη	Προκαθορισμ	Ελάχιστη	Μέγιστη	Προκαθορισμ
3 A	I _{sald}	-	1%	100%	50%

12 Συχνότητα παλμικού



Επιτρέπει τη ρύθμιση της συχνότητας παλμού.

Επιτρέπει τη βελτίωση του αποτελέσματος σε συγκολλήσεις λεπτού πάχους και καλύτερη αισθητική εμφάνιση της ραφής.

Ελάχιστη	Μέγιστη	Προκαθορισμ
0.1 Hz	25 Hz	5 Hz

13 Duty cycle παλμικού



Επιτρέπει τη ρύθμιση του duty cycle σε παλμικό.

Επιτρέπει τη διατήρηση του ρεύματος αιχμής για μικρότερη ή μεγαλύτερη χρονική διάρκεια.

Ελάχιστη	Μέγιστη	Προκαθορισμ
1 %	99 %	50 %

14 Συχνότητα Fast Pulse



Επιτρέπει τη ρύθμιση της συχνότητας παλμού.

Επιτρέπει τη επίτευξη μεγαλύτερης συγκέντρωσης και σταθερότητας του ηλεκτρικού τόξου.

Ελάχιστη	Μέγιστη	Προκαθορισμ
0.02 KHz	2.5 KHz	0.25 KHz

15 Σταδιακές αυξομειώσεις παλμικού



Επιτρέπει τον καθορισμό ενός χρόνου σταδιακής καθόδου κατά το στάδιο των παλμών.

Επιτρέπει την επίτευξη μίας σταδιακής μετάβασης από το ρεύμα αιχμής στο ρεύμα βάσης, καθιστώντας το τόξο πολύ ή λίγο "απαλό".

Ελάχιστη	Μέγιστη	Προκαθορισμ
0/μακριά από	100 %	0/μακριά από

16 Σταδιακή κάθοδος



Επιτρέπει τη σταδιακή μετάβαση, από το ρεύμα συγκόλλησης στο τελικό ρεύμα.

Ελάχιστη	Μέγιστη	Προκαθορισμ
0/μακριά από	99.9 s	0/μακριά από

17 Τελικό ρεύμα



Επιτρέπει τη ρύθμιση του τελικού ρεύματος.

Ελάχιστη	Μέγιστη	Προκαθορισμ	Ελάχιστη	Μέγιστη	Προκαθορισμ
3 A	I _{max}	10 A	1 %	200 %	50 %

19 Χρόνος τελικού ρεύματος



Επιτρέπει τον καθορισμό της χρονικής διάρκειας διατήρησης του τελικού ρεύματος.

Ελάχιστη	Μέγιστη	Προκαθορισμ
0/μακριά από	99.9 s	0/μακριά από

20 Post gas



Επιτρέπει τη ρύθμιση της ροής αερίου, στο τέλος της συγκόλλησης.

Ελάχιστη	Μέγιστη	Προκαθορισμ
0/μακριά από	99.9 s	syn

203 Tig start (HF)

Επιτρέπει την επιλογή του επιθυμητού τρόπου έναυσης.

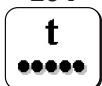
Τιμή	Προκαθορισμ	Λειτουργία επανάκλισης
on	X	HF START
μακριά από	-	LIFT START

204 Ποντάρισμα (σημειακή συγκόλληση)

Επιτρέπει την ενεργοποίηση της διαδικασίας "πονταρίσματος" (σημειακής συγκόλλησης) και την επιλογή του χρόνου συγκόλλησης.

Επιτρέπει το χρονισμό του τρόπου συγκόλλησης

Ελάχιστη	Μέγιστη	Προκαθορισμ
0/μακριά από	99.9 s	0/μακριά από

205 Restart

Επιτρέπει την ενεργοποίησης της λειτουργίας restart.

Επιτρέπει το άμεσο σβήσιμο του τόξου κατά τη σταδιακή κάθοδο ή την επανεκκίνηση του κύκλου συγκόλλησης.

Τιμή	Προκαθορισμ	Λειτουργία επανάκλισης
0/μακριά από	-	μακριά από
1/on	X	on
2/of1	-	μακριά από

206 Easy joining

Επιτρέπει την έναυση του τόξου με παλμικό ρεύμα και το χρονισμό της λειτουργίας πριν από την αυτόματη αποκατάσταση των προκαθορισμένων συνθηκών συγκόλλησης.

Επιτρέπει την επίτευξη μεγαλύτερης ταχύτητας και ακρίβειας κατά τις εργασίες πονταρίσματος (σημειακής συγκόλλησης) των κομματιών.

Ελάχιστη	Μέγιστη	Προκαθορισμ
0.1 s	25.0 s	0/μακριά από

208 Microtime spot welding

Επιτρέπει την ενεργοποίηση της διαδικασίας "microtime spot welding".

Επιτρέπει το χρονισμό του τρόπου συγκόλλησης

Ελάχιστη	Μέγιστη	Προκαθορισμ
0.01 s	1.00 s	0/μακριά από

399 Ταχύτητα μετατόπισης

Επιτρέπει τη ρύθμιση της ταχύτητας εκτέλεσης της συγκόλλησης.

Default cm/min: ταχύτητα αναφοράς για τη χειροκίνητη συγκόλληση.

Syn: Sinergic αξία.

Ελάχιστη	Μέγιστη	Προκαθορισμ
2 cm/min	200 cm/min	10 cm/min

500 Προγραμματισμός μηχανήματος

Επιτρέπει την επιλογή της επιθυμητής γραφικής διεπαφής.

Επιτρέπει την πρόσβαση στα ανώτερα επίπεδα του set up.

βλ. παράγραφο "Εξατομίκευση οθόνης (Set up 500)"

Τιμή	Επιλεγμένο επίπεδο	Τιμή	Διεπαφή Χρήστη
USER	Χρήστης	XE	Τρόπος Easy
SERV	Service	XA	Τρόπος Advanced
vaBW	vaBW	XP	Τρόπος Professional

551 Lock/unlock

Επιτρέπει το μπλοκάρισμα των οργάνων ελέγχου και την εισαγωγή ενός κωδικού ασφαλείας.

βλ. παράγραφο "Lock/unlock (Set up 551)".

552 Τόνος βομβητή

Επιτρέπει την επιλογή τόνου του βομβητή.



Ελάχιστη	Μέγιστη	Προκαθορισμ
0/μακριά από	10	10

601 Βήμα ρύθμισης

Επιτρέπει τη ρύθμιση μιας παραμέτρου, με βήμα που μπορεί να επιλεγεί από το χρήστη.



Ελάχιστη	Μέγιστη	Προκαθορισμ
1	lmax	1

602 Εξωτερική παράμετρος CH1, CH2, CH3, CH4

Επιτρέπει τη διαχείριση της εξωτερικής παραμέτρου 1, 2, 3, 4 (ελάχιστη τιμή, μέγιστη τιμή, προκαθορισμένη τιμή, επιλεγμένη παράμετρος).

βλ. παράγραφο "διαχείριση εξωτερικών εντολών (Set up 602)".

**606 Τσιμπίδα U/D**

Επιτρέπει τη διαχείριση της εξωτερικής παραμέτρου (U/D).



Τιμή	Προκαθορισμ	Λειτουργία επανάκλησης
0/μακριά από	-	μακριά από
1/11	X	Ένταση (ρεύμα)
	-	Άνοιγμα προγραμμάτων

612 Ρύθμιση τσιμπίδας DgTig

Επιτρέπει τη διαχείριση των καναλιών της ψηφιακής τσιμπίδας.



Τιμή	Προκαθορισμ	Λειτουργία επανάκλησης
0/μακριά από	-	μακριά από
1/11	-	Ένταση (ρεύμα)
2/ 	-	Άνοιγμα προγραμμάτων
3/CH3	-	CH3
4/CH4	-	CH4
5/STD	X	STD

705 Διακρίβωση αντίστασης κυκλώματος

Επιτρέπει τη βαθμονόμηση της εγκατάστασης.

βλ. παράγραφο "Διακρίβωση αντίστασης κυκλώματος (set up 705)".

**751 Καταγραφή ρεύματος**

Επιτρέπει την εμφάνιση της πραγματικής τιμής του ρεύματος συγκόλλησης.

**752 Καταγραφή τάσης**

Επιτρέπει την εμφάνιση της πραγματικής τιμής της τάσης συγκόλλησης.

**758 Ταχύτητα μετατόπισης ρομπότ**

Επιτρέπει την εμφάνιση της ταχύτητας μετατόπισης του βραχίονα ενός ρομπότ ή κάποιας αυτόματης διάταξης.

**764 Καταγραφή παροχής ψυκτικού υγρού**

Επιτρέπει την εμφάνιση της πραγματικής τιμής παροχής ψυκτικού υγρού.

**765 Καταγραφή θερμοκρασία ψυκτικού υγρού**

Επιτρέπει την εμφάνιση της πραγματικής τιμής Θερμοκρασία ψυκτικού υγρού.



768 Μέτρηση θερμικής παροχής HI

Επιτρέπει την εμφάνιση της τιμής μέτρησης της θερμικής παροχής σε συγκόλληση.

801 Όρια επιφυλακής

Επιτρέπει τον προγραμματισμό των ορίων προσοχής και των ορίων επιφυλακής.



Επιτρέπει τον έλεγχο του τρόπου συγκόλλησης, καθορίζοντας κάποια όρια προσοχής και όρια επιφυλακής, στις βασικές μετρήσιμες παραμέτρους.

Επιτρέπει τον επιμελή έλεγχο των διαφόρων φάσεων συγκόλλησης.

5.2 Ειδικές διαδικασίες χρήσης των παραμέτρων
5.2.1 Εξατομίκευση οθόνης 7 τμημάτων

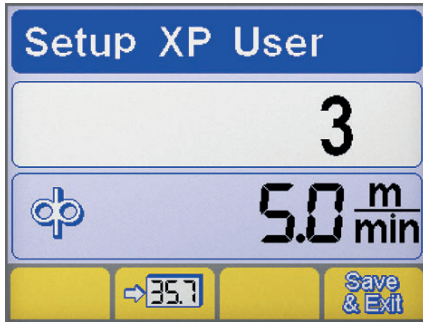
Επιτρέπει τη συνεχή εμφάνιση της τιμής μιας παραμέτρου στην οθόνη 7 τμημάτων.



- ▶ Μπείτε στο set up, πατώντας το πλήκτρο encoder, για 5 τουλάχιστον δευτερόλεπτα.
- ▶ Επιλέξτε την παράμετρο που θέλετε.
- ▶ Αποθηκεύστε στη μνήμη την παράμετρο που έχει επιλεγεί στην οθόνη 7 τμημάτων, πατώντας το πλήκτρο .
- ▶ Αποθηκεύστε στη μνήμη και βγείτε από την τρέχουσα σελίδα, πατώντας το πλήκτρο .

5.2.2 Εξατομίκευση οθόνης (Set up 500)

Επιτρέπει την εξατομίκευση των παραμέτρων της αρχικής σελίδας.













500 Προγραμματισμός μηχανήματος

Επιτρέπει την επιλογή της επιθυμητής γραφικής διεπαφής.











Τιμή	Διεπαφή Χρήστη
XE	Τρόπος Easy
XA	Τρόπος Advanced
XP	Τρόπος Professional

ΛΕΙΤΟΥΡΓΙΑ XE

MMA	
Παράμετροι συγκόλλησης	
TIG	
Παράμετροι συγκόλλησης	    
Λειτουργίες	      

ΛΕΙΤΟΥΡΓΙΑ XA

MMA	
Παράμετροι συγκόλλησης	  
Λειτουργίες	    

TIG

Παράμετροι συγκόλλησης								
Λειτουργίες								

ΛΕΙΤΟΥΡΓΙΑ ΧΡ

MMA

Παράμετροι συγκόλλησης					
Λειτουργίες					

TIG

Παράμετροι συγκόλλησης											
Λειτουργίες											

5.2.3 Lock/unlock (Set up 551)

Επιτρέπεται το μπλοκάρισμα των οργάνων ελέγχου και την εισαγωγή ενός κωδικού ασφαλείας.

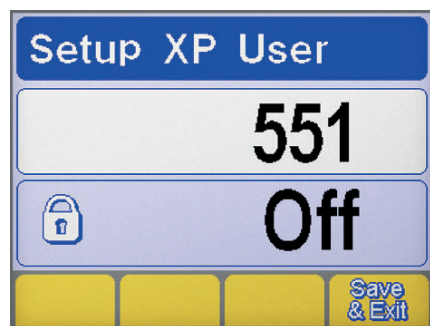

Επιλογή παραμέτρου

- ▶ Μπείτε στο set up, πατώντας το πλήκτρο encoder, για 5 τουλάχιστον δευτερόλεπτα.
- ▶ Επιλέξτε την παράμετρο που θέλετε (551).
- ▶ Ενεργοποιήστε τη ρύθμιση της επιλεγμένης παραμέτρου, πατώντας το πλήκτρο encoder.

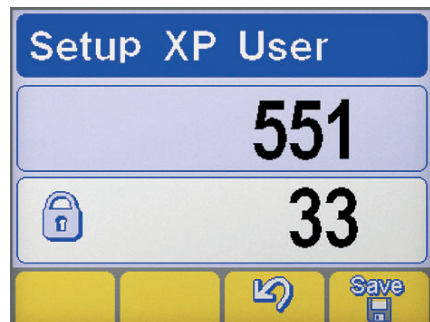

Ορισμός κωδικού

- ▶ Εισάγετε έναν αριθμητικό κωδικό (password), περιστρέφοντας το encoder.
- ▶ Επιβεβαιώστε την ενέργεια πιέζοντας το κουμπί-encoder.
- ▶ Επιβεβαιώστε την ενέργεια, πατώντας το πλήκτρο
- ▶ Για αποθήκευση της τροποποίησης πιέστε το κουμπί:

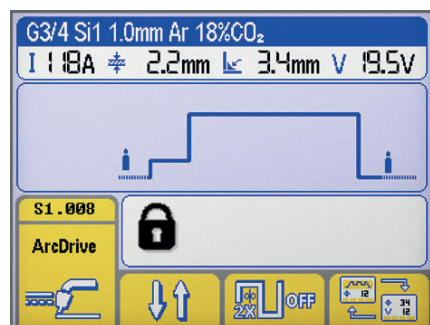

Λειτουργίες πίνακα



Αν εκτελεστεί μια οποιαδήποτε ενέργεια, όταν ο πίνακας είναι μπλοκαρισμένος, εμφανίζεται μία σελίδα με ειδικές ενδείξεις.

- ▶ Μπείτε προσωρινά (5 λεπτά) στις λειτουργίες του πίνακα ελέγχου: περιστρέψτε το encoder και εισάγετε το σωστό αριθμητικό κωδικό.
- ▶ Επιβεβαιώστε την ενέργεια πιέζοντας το κουμπί-encoder.
- ▶ Απελευθερώστε οριστικά τον πίνακα ελέγχου: μπείτε στο set up (σύμφωνα με τις οδηγίες που υπάρχουν παραπάνω) και επαναφέρετε το "off" στην παράμετρο 551.
- ▶ Επιβεβαιώστε την ενέργεια πιέζοντας το κουμπί-encoder.
- ▶ Για αποθήκευση της τροποποίησης πιέστε το κουμπί:

5.2.4 Διαχείριση εξωτερικών εντολών (Set up 602)

Επιτρέπει τη διαχείριση της εξωτερικής παραμέτρου 2 (ελάχιστη τιμή, μέγιστη τιμή, προκαθορισμένη τιμή, επιλεγμένη παράμετρος).



Επιλογή παραμέτρου

- ▶ Μπείτε στο set up, πατώντας το πλήκτρο encoder, για 5 τουλάχιστον δευτερόλεπτα.
- ▶ Επιλέξτε την παράμετρο που θέλετε (602).
- ▶ Μπείτε στη σελίδα "Διαχείριση εξωτερικών εντολών", πατώντας το πλήκτρο encoder.

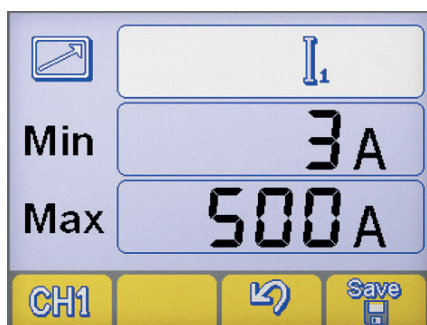

Διαχείριση εξωτερικών εντολών

- ▶ Επιλέξτε την επιθυμητή έξοδο ελέγχου RC (CH1, CH2, CH3, CH4), πατώντας το κουμπί .
- ▶ Επιλέξτε την παράμετρο που θέλετε (Min-Max-παράμετρο), πατώντας το πλήκτρο encoder.
- ▶ Ρυθμίστε την παράμετρο που θέλετε (Min-Max-παράμετρο), περιστρέφοντας το encoder.
- ▶ Για αποθήκευση της τροποποίησης πιέστε το κουμπί: .
- ▶ Επιβεβαιώστε την ενέργεια, πατώντας το πλήκτρο .

5.2.5 Διακρίβωση αντίστασης κυκλώματος (set up 705)

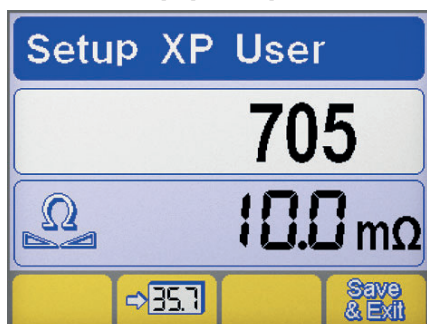

Επιλογή παραμέτρου

- ▶ Μπείτε στο set up, πατώντας το πλήκτρο encoder, για 5 τουλάχιστον δευτερόλεπτα.
- ▶ Επιλέξτε την παράμετρο που θέλετε (705).
- ▶ Ενεργοποιήστε τη ρύθμιση της επιλεγμένης παραμέτρου, πατώντας το πλήκτρο encoder.

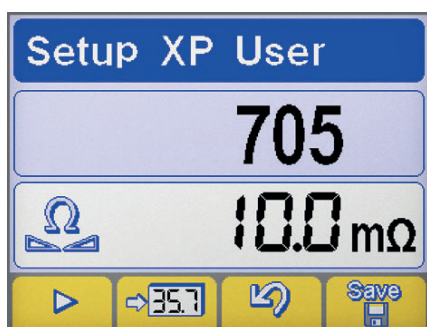

Κυκλώματος

- ▶ Φέρτε σε ηλεκτρική επαφή ηλεκτρόδιο βολφραμίου και το προς συγκόλληση κομμάτι. (TIG)
- ▶ Φέρτε σε επαφή τον φακό του ηλεκτροδίου και το προς συγκόλληση τεμάχιο. (MMA)
- ▶ Πατήστε το πλήκτρο (ή κουμπί της τσιμπίδας) για να αρχίσετε τη διαδικασία.
- ▶ Κρατήστε την επαφή τουλάχιστον για ένα δευτερόλεπτο.
- ▶ Η τιμή που εμφανίζεται στην οθόνη ενημερώνεται μετά τη βαθμονόμηση.
- ▶ Επιβεβαιώστε την ενέργεια, πατώντας το πλήκτρο .
- ▶ Επιβεβαιώστε την ενέργεια, πατώντας το πλήκτρο .
- ▶ Για αποθήκευση της τροποποίησης και έξοδο από το set up πιέστε το κουμπί: .

5.2.6 Όρια επιφυλακής (Set up 801)

Επιτρέπει τον προγραμματισμό των ορίων προσοχής και των ορίων επιφυλακής.

Επιτρέπει τον έλεγχο του τρόπου συγκόλλησης, καθορίζοντας κάποια όρια προσοχής και όρια επιφυλακής, στις βασικές μετρήσιμες παραμέτρους.

Επιτρέπει τον επιμελή έλεγχο των διαφόρων φάσεων συγκόλλησης.

βλ. παράγραφο "Όρια επιφυλακής (Set up 801)".



Ρεύμα συγκόλλησης



Τάση συγκόλλησης



Καταγραφή παροχής αερί



Ταχύτητα μετατόπισης ρομπότ



Καταγραφή ρεύματος (μοτέρ 1)



Καταγραφή ρεύματος (μοτέρ 2)



Καταγραφή παροχής ψυκτικού υγρού



Ταχύτητα σύρματος



Καταγραφή θερμοκρασία ψυκτικού υγρού

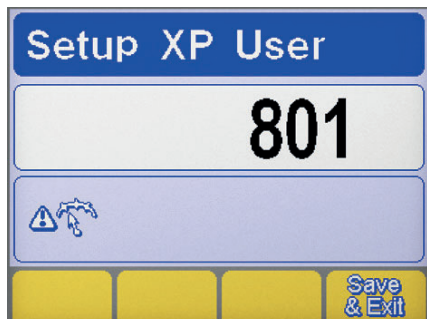

Επιλογή παραμέτρου

- ▶ Μπείτε στο set up, πατώντας το πλήκτρο encoder, για 5 τουλάχιστον δευτερόλεπτα.
- ▶ Επιλέξτε την παράμετρο που θέλετε (801).
- ▶ Μπείτε στη σελίδα "Όρια επιφυλακής", πατώντας το πλήκτρο encoder.

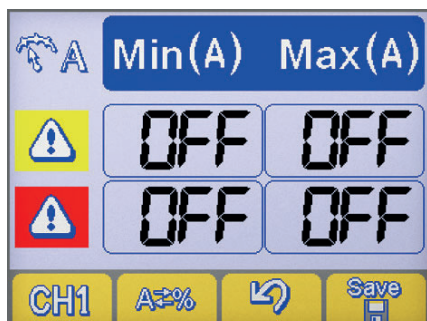

Επιλογή της παραμέτρου

- ▶ Επιλέξτε την παράμετρο που θέλετε, πατώντας το πλήκτρο **CH1**.
- ▶ Επιλέξτε τον τρόπο ρύθμισης των ορίων επιφυλακής, πατώντας το πλήκτρο **A=%**.



Προγραμματισμός μηχανήματος



Απόλυτη τιμή



Ποσοστιαία τιμή

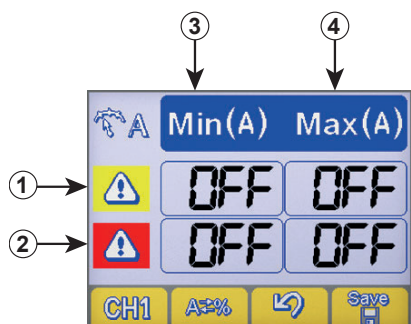

Προγραμματισμός ορίων επιφυλακής

- 1 Γραμμή των ορίων προσοχής
- 2 Γραμμή των ορίων συναγερμού
- 3 Στήλη των ελάχιστων σταθμών
- 4 Στήλη των μέγιστων σταθμών

- ▶ Επιλέξτε τη θέση που θέλετε, πατώντας το πλήκτρο encoder (η επιλεγμένη θέση επισημαίνεται με το μαυρισμένο φόντο).
- ▶ Ρυθμίστε τη στάθμη του ορίου που επιλέξατε, περιστρέφοντας το encoder.
- ▶ Για αποθήκευση της τροποποίησης πιέστε το κουμπί: **Save**.



Σε περίπτωση που ξεπεραστεί κάποιο όριο προσοχής, στον πίνακα ελέγχου εμφανίζεται μία προειδοποιητική ένδειξη.



Σε περίπτωση που ξεπεραστεί κάποιο όριο επιφυλακής (συναγερμού), στον πίνακα ελέγχου εμφανίζεται μία προειδοποιητική ένδειξη και μπλοκάρονται αμέσως όλες οι λειτουργίες συγκόλλησης.



Μπορείτε να ενεργοποιήσετε τα φίλτρα έναρξης και τέλους συγκόλλησης, για να αποφύγετε την εμφάνιση ενδείξεων σφάλματος κατά την έναυση και το σβήσιμο του τόξου (βλ. παράγραφο "Set up" - παράμετροι 802-803-804).

6. ΣΥΝΤΗΡΗΣΗ

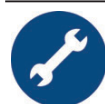

Η διάταξη πρέπει να συντηρείται τακτική, σύμφωνα με τις οδηγίες του κατασκευαστή. Όλες οι θυρίδες πρόσβασης και συντήρησης, καθώς και τα καπάκια, πρέπει να είναι κλειστά και καλά στερωμένα, όταν η συσκευή βρίσκεται σε λειτουργία. Απαγορεύεται οποιαδήποτε μετατροπή της διάταξης. Μην επιτρέπετε τη συσσώρευση μεταλλικής σκόνης γύρω από τα πτερώγια αερισμού.



Η ενδεχόμενη συντήρηση πρέπει να εκτελείται μόνο από εξειδικευμένους τεχνικούς. Η επισκευή ή η αντικατάσταση εξαρτημάτων της διάταξης από μη εξειδικευμένο προσωπικό έχει ως συνέπεια την άμεση ακύρωση της εγγύησης του προϊόντος. Η ενδεχόμενη επισκευή ή αντικατάσταση εξαρτημάτων της διάταξης, πρέπει να γίνεται αποκλειστικά από εξειδικευμένους τεχνικούς.



Διακόπτετε την τροφοδοσία ρεύματος, πριν από κάθε επέμβαση!

6.1 Περιοδικοί έλεγχοι

6.1.1 Εγκατάσταση



Καθαρίστε το εσωτερικό με πεπιεσμένο αέρα σε χαμηλή πίεση και μαλακό πινέλο. Ελέγχετε τις ηλεκτρικές συνδέσεις και όλα τα καλώδια σύνδεσης.

6.1.2 Για τη συντήρηση ή την αντικατάσταση των εξαρτημάτων των τσιμπιδών, των τσιμπιδών ηλεκτροδίου και/ή των καλωδίων σώματος γείωσης:



Ελέγξτε τη θερμοκρασία των εξαρτημάτων, για να διαπιστώσετε αν έχουν υπερθερμανθεί.



Χρησιμοποιείτε πάντα γάντια εγκεκριμένου τύπου.



Χρησιμοποιείτε κατάλληλα κλειδιά και εργαλεία.

6.2 Ευθύνη



Σε περίπτωση που δεν γίνεται η συνιστώμενη συντήρηση, παύει η ισχύς όλων των εγγυήσεων και ο κατασκευαστής απαλλάσσεται από οποιαδήποτε ευθύνη. Ο κατασκευαστής δεν φέρει καμία ευθύνη, σε περίπτωση που ο χειριστής δε συμμορφωθεί με τις οδηγίες. Για κάθε αμφιβολία και/ή πρόβλημα, μη διστάσετε να απευθυνθείτε στο πλησιέστερο κέντρο τεχνικής υποστήριξης.

7. ΚΩΔΙΚΟΪ ΣΥΝΑΓΕΡΜΩΝ (ΑΛΑΡΜ)



ΣΥΝΑΓΕΡΜΟΣ









Η επέμβαση ενός συναγερμού ή η υπέρβαση ενός κρίσιμου ορίου επιτήρησης, προκαλεί μια οπτική σήμανση στον πίνακα χειριστηρίων και την άμεση διακοπή των εργασιών συγκόλλησης.















ΠΡΟΣΟΧΗ

Η υπέρβαση ενός ορίου επιφυλακής ενεργοποιεί μία οπτική σήμανση στον πίνακα χειρισμού, αλλά επιτρέπει τη συνέχιση της διαδικασίας συγκόλλησης.

Στη συνέχεια παρουσιάζονται όλοι οι συναγερμοί και όλα τα όρια επιτήρησης σχετικά με την εγκατάσταση.

 E01	Υπερθέρμανση		 E02	Υπερθέρμανση	
 E03	Υπερθέρμανση		 E05	Υπερένταση	
 E06	Υπερένταση μονάδας ισχύος (Boost)		 E07	Ανωμαλία συστήματος τροφοδοσίας του κινητήρα έλξης σύρματος	
 E08	Αποκλεισμένος κινητήρας		 E10	Υπερένταση μονάδας ισχύος (Inverter)	
 E11	Σφάλμα διαμόρφωσης εγκατάστασης		 E13	Σφάλμα επικοινωνίας (FP)	

 E14.xx	Μη έγκυρο πρόγραμμα ο υποκωδικός του σφάλματος υποδηλώνει τον αριθμό της εργασίας που διαγράφηκε		 E15	Μη έγκυρο πρόγραμμα	
 E16	Σφάλμα επικοινωνίας (RI) (Αυτοματισμοί και ρομπότ)		 E18.xx	Μη έγκυρο πρόγραμμα ο υποκωδικός του σφάλματος υποδηλώνει τον αριθμό της εργασίας που διαγράφηκε	
 E19	Σφάλμα διαμόρφωσης εγκατάστασης		 E20	Βλάβη μνήμης	
 E21	Απώλεια δεδομένων		 E22	Σφάλμα επικοινωνίας (DSP)	
 E27	Βλάβη μνήμης (RTC)		 E29	Ασύμβατα μεγέθη	
 E30	Σφάλμα επικοινωνίας (H.F.)		 E32	Απώλεια δεδομένων	
 E33	Σφάλμα διαμόρφωσης εγκατάστασης (LCD 3.5")		 E38	Υπόταση	
 E39	Ανωμαλία τροφοδοσίας εγκατάστασης		 E40	Ανωμαλία τροφοδοσίας εγκατάστασης	
 E41	Υπέρταση		 E42	Υπόταση	
 E43	Απουσία ψυκτικού υγρού		 E49	Διακόπτης έκτακτης ανάγκης (Αυτοματισμοί και ρομπότ)	
 E51	Μη υποστηριζόμενες ρυθμίσεις (Αυτοματισμοί και ρομπότ)		 E52	Προστασία από προσκρούσεις (Αυτοματισμοί και ρομπότ)	
 E53	Σφάλμα εξωτερικού ροοστάτη (Αυτοματισμοί και ρομπότ)		 E54	Υπέρβαση ορίου έντασης (Κατώτερο όριο)	
 E55	Υπέρβαση ορίου έντασης (Ανώτερο όριο)		 E56	Υπέρβαση ορίου τάσης (Κατώτερο όριο)	
 E57	Υπέρβαση ορίου τάσης (Ανώτερο όριο)		 E58	Υπέρβαση ορίου ροής αερίου (Κατώτερο όριο)	
 E59	Υπέρβαση ορίου ροής αερίου (Ανώτερο όριο)		 E62	Υπέρβαση ορίου έντασης (Κατώτερο όριο)	
 E63	Υπέρβαση ορίου έντασης (Ανώτερο όριο)		 E64	Υπέρβαση ορίου τάσης (Κατώτερο όριο)	
 E65	Υπέρβαση ορίου τάσης (Ανώτερο όριο)		 E66	Υπέρβαση ορίου ροής αερίου (Κατώτερο όριο)	

 E67	Υπέρβαση ορίου ροής αερίου (Ανώτερο όριο)		Υπερθέρμανση ψυκτικού υγρού		E72	Υπερένταση κινητήρα push-pull		Υπέρβαση ορίου ταχύτητας σύρματος (speed meter)		E75	Υπέρβαση ορίου ρεύματος κινητήρα 2		E76	Υπέρβαση ορίου ροής ψυκτικού υγρού		E77	Υπέρβαση ορίου θερμοκρασίας ψυκτικού υγρού		E78	Συντήρηση σε εξέλιξη (Αυτοματισμοί και ρομπότ)		E81	Υπερένταση (αντλία WU)		E82	Σφάλμα επικοινωνίας (WU)		E83	Εμπλοκή αντλίας		E99	Γενικός συναγερμός
---	---	---	-----------------------------	---	-----	-------------------------------	---	---	---	-----	------------------------------------	---	-----	------------------------------------	---	-----	--	---	-----	--	---	-----	------------------------	---	-----	--------------------------	---	-----	-----------------	---	-----	--------------------

8. ΔΙΑΓΝΩΣΗ ΠΡΟΒΛΗΜΑΤΩΝ ΚΑΙ ΛΥΣΕΙΣ

Αποτυχία ανάμματος της συσκευής (πράσινη λυχνία σβηστή)

Αιτία

- » Απουσία τάσης στην πρίζα τροφοδοσίας.
- » Ελαττωματικό φισ ή ηλεκτρικό καλώδιο.
- » Καμένη ασφάλεια γραμμής.
- » Διακόπτης τροφοδοσίας ελαττωματικός.
- » Ηλεκτρονικά μέρη ελαττωματικά.

Λύση

- » Ελέγξτε και ενδεχομένως επισκευάστε την ηλεκτρική εγκατάσταση.
- » Απευθυνθείτε σε εξειδικευμένο προσωπικό.
- » Αντικαταστήστε το ελαττωματικό εξάρτημα.
- » Απευθυνθείτε στο πλησιέστερο κέντρο τεχνικής υποστήριξης, για την επισκευή της διάταξης.
- » Αντικαταστήστε το ελαττωματικό εξάρτημα.
- » Αντικαταστήστε το ελαττωματικό εξάρτημα.
- » Απευθυνθείτε στο πλησιέστερο κέντρο τεχνικής υποστήριξης, για την επισκευή της διάταξης.
- » Απευθυνθείτε στο πλησιέστερο κέντρο τεχνικής υποστήριξης, για την επισκευή της διάταξης.

Απουσία ισχύος στην έξοδο (η μηχανή δεν εκτελεί συγκόλληση)

Αιτία

- » Ελαττωματικό μπουτόν τσιμπίδας.
- » Υπερθέρμανση μηχανής (συναγερμός θερμοκίας ασφάλειας - κίτρινη λυχνία αναμμένη).
- » Λανθασμένη σύνδεση σώματος γείωσης.
- » Τάση δικτύου εκτός εύρους προκαθορισμένων τιμών (κίτρινη λυχνία αναμμένη).
- » Ελαττωματικός αυτόματος διακόπτης.
- » Ηλεκτρονικά μέρη ελαττωματικά.

Λύση

- » Αντικαταστήστε το ελαττωματικό εξάρτημα.
- » Απευθυνθείτε στο πλησιέστερο κέντρο τεχνικής υποστήριξης, για την επισκευή της διάταξης.
- » Περιμένετε να κρυώσει η μηχανή, χωρίς να την σβήσετε.
- » Κάντε σωστά τη σύνδεση του σώματος γείωσης.
- » Συμβουλευθείτε την παράγραφο "Θέση σε λειτουργία".
- » Επαναφορά της τάσης δικτύου εντός των ορίων τροφοδοσίας της γεννήτριας.
- » Συνδέστε σωστά τη διάταξη.
- » Συμβουλευθείτε την παράγραφο "Σύνδεση".
- » Αντικαταστήστε το ελαττωματικό εξάρτημα.
- » Απευθυνθείτε στο πλησιέστερο κέντρο τεχνικής υποστήριξης, για την επισκευή της διάταξης.
- » Απευθυνθείτε στο πλησιέστερο κέντρο τεχνικής υποστήριξης, για την επισκευή της διάταξης.

Λανθασμένη παροχή ισχύος

Αιτία

- » Λανθασμένη επιλογή διαδικασίας συγκόλλησης ή ελαττωματικός διακόπτης επιλογής.

Λύση

- » Επιλέξτε τη σωστή διαδικασία συγκόλλησης.

- » Λανθασμένες ρυθμίσεις παραμέτρων και λειτουργιών της διάταξης.
- » Ελαττωματικό ποτενσιόμετρο/encoder για τη ρύθμιση του ρεύματος συγκόλλησης.
- » Τάση δικτύου εκτός εύρους προκαθορισμένων τιμών.
- » Απουσία μιας φάσης.
- » Ηλεκτρονικά μέρη ελαττωματικά.

- » Reset εγκατάστασης και επαναπρογραμματισμός των παραμέτρων συγκόλλησης.
- » Αντικαταστήστε το ελαττωματικό εξάρτημα.
- » Απευθυνθείτε στο πλησιέστερο κέντρο τεχνικής υποστήριξης, για την επισκευή της διάταξης.
- » Συνδέστε σωστά τη διάταξη.
- » Συμβουλευθείτε την παράγραφο “Σύνδεση”.
- » Συνδέστε σωστά τη διάταξη.
- » Συμβουλευθείτε την παράγραφο “Σύνδεση”.
- » Απευθυνθείτε στο πλησιέστερο κέντρο τεχνικής υποστήριξης, για την επισκευή της διάταξης.

Αστάθεια τόξου

Αιτία

- » Ανεπαρκής προστασία του αερίου.
- » Υγρασία στο αέριο συγκόλλησης.
- » Λανθασμένες παράμετροι συγκόλλησης.

Λύση

- » Ρυθμίστε σωστά τη ροή αερίου.
- » Βεβαιωθείτε ότι το στόμιο και το μπεκ αερίου της τσιμπίδας βρίσκονται σε καλή κατάσταση.
- » Χρησιμοποιείτε πάντοτε προϊόντα και υλικά καλής ποιότητας.
- » Διατηρείτε σε άριστη κατάσταση τη διάταξη τροφοδοσίας αερίου.
- » Ελέγξτε προσεκτικά τη διάταξη συγκόλλησης.
- » Απευθυνθείτε στο πλησιέστερο κέντρο τεχνικής υποστήριξης, για την επισκευή της διάταξης.

Υπερβολικά πιτσιλίσματα

Αιτία

- » Λανθασμένο μήκος τόξου.
- » Λανθασμένες παράμετροι συγκόλλησης.
- » Ανεπαρκής προστασία του αερίου.
- » Λανθασμένη δυναμική τόξου.
- » Λανθασμένος τρόπος εκτέλεσης συγκόλλησης.

Λύση

- » Μειώστε την απόσταση μεταξύ ηλεκτροδίου και τεμαχίου.
- » Μειώστε την τάση συγκόλλησης.
- » Ελαττώστε το ρεύμα συγκόλλησης.
- » Ρυθμίστε σωστά τη ροή αερίου.
- » Βεβαιωθείτε ότι το στόμιο και το μπεκ αερίου της τσιμπίδας βρίσκονται σε καλή κατάσταση.
- » Αυξήστε την επαγωγική τιμή του κυκλώματος.
- » Ελαττώστε την κλίση της τσιμπίδας.

Ανεπαρκής διείσδυση

Αιτία

- » Λανθασμένος τρόπος εκτέλεσης συγκόλλησης.
- » Λανθασμένες παράμετροι συγκόλλησης.
- » Ακατάλληλο ηλεκτρόδιο.
- » Λανθασμένη προετοιμασία άκρων.
- » Λανθασμένη σύνδεση σώματος γείωσης.
- » Μεγάλες διαστάσεις των προς συγκόλληση κομματιών.

Λύση

- » Ελαττώστε την ταχύτητα προώθησης της συγκόλλησης.
- » Αυξήστε το ρεύμα συγκόλλησης.
- » Χρησιμοποιήστε ηλεκτρόδιο με μικρότερη διάμετρο.
- » Αυξήστε το άνοιγμα του διάκενου.
- » Κάντε σωστά τη σύνδεση του σώματος γείωσης.
- » Συμβουλευθείτε την παράγραφο “Θέση σε λειτουργία”.
- » Αυξήστε το ρεύμα συγκόλλησης.

Εγκλωβισμός σκουριάς

Αιτία

- » Ατελής απομάκρυνση της σκουριάς.
- » Πολύ μεγάλη διάμετρος ηλεκτροδίου.
- » Λανθασμένη προετοιμασία άκρων.
- » Λανθασμένος τρόπος εκτέλεσης συγκόλλησης.

Λύση

- » Καθαρίστε καλά τα κομμάτια, πριν τη συγκόλληση.
- » Χρησιμοποιήστε ηλεκτρόδιο με μικρότερη διάμετρο.
- » Αυξήστε το άνοιγμα του διάκενου.
- » Μειώστε την απόσταση μεταξύ ηλεκτροδίου και τεμαχίου.
- » Κινηθείτε με ομαλό ρυθμό, σε όλες τις φάσεις συγκόλλησης.

Εγκλωβισμός βολφραμίου
Αιτία

- » Λανθασμένες παράμετροι συγκόλλησης.
- » Ακατάλληλο ηλεκτρόδιο.
- » Λανθασμένος τρόπος εκτέλεσης συγκόλλησης.

Λύση

- » Ελαττώστε το ρεύμα συγκόλλησης.
- » Χρησιμοποιήστε ένα ηλεκτρόδιο με μεγαλύτερη διάμετρο.
- » Χρησιμοποιείτε πάντοτε προϊόντα και υλικά καλής ποιότητας.
- » Τροχίστε σωστά το ηλεκτρόδιο.
- » Αποφύγετε τις επαφές μεταξύ ηλεκτροδίου και λουτρού συγκόλλησης.

Φυσήματα
Αιτία

- » Ανεπαρκής προστασία του αερίου.

Λύση

- » Ρυθμίστε σωστά τη ροή αερίου.
- » Βεβαιωθείτε ότι το στόμιο και το μπεκ αερίου της τσιμπίδας βρίσκονται σε καλή κατάσταση.

Κολλήματα
Αιτία

- » Λανθασμένο μήκος τόξου.
- » Λανθασμένες παράμετροι συγκόλλησης.
- » Λανθασμένος τρόπος εκτέλεσης συγκόλλησης.
- » Μεγάλες διαστάσεις των προς συγκόλληση κομματιών.
- » Λανθασμένη δυναμική τόξου.

Λύση

- » Αυξήστε την απόσταση μεταξύ ηλεκτροδίου και κομματιού.
- » Αυξήστε την τάση συγκόλλησης.
- » Αυξήστε το ρεύμα συγκόλλησης.
- » Αυξήστε την τάση συγκόλλησης.
- » Αυξήστε περισσότερο την γωνία κλίσης της τσιμπίδας.
- » Αυξήστε το ρεύμα συγκόλλησης.
- » Αυξήστε την τάση συγκόλλησης.
- » Αυξήστε την επαγωγική τιμή του κυκλώματος.

Ρηγματώσεις στις άκρες
Αιτία

- » Λανθασμένες παράμετροι συγκόλλησης.
- » Λανθασμένο μήκος τόξου.
- » Λανθασμένος τρόπος εκτέλεσης συγκόλλησης.
- » Ανεπαρκής προστασία του αερίου.

Λύση

- » Ελαττώστε το ρεύμα συγκόλλησης.
- » Χρησιμοποιήστε ηλεκτρόδιο με μικρότερη διάμετρο.
- » Μειώστε την απόσταση μεταξύ ηλεκτροδίου και τεμαχίου.
- » Μειώστε την τάση συγκόλλησης.
- » Μειώστε την ταχύτητα πλευρικής ταλάντωσης κατά το γέμισμα.
- » Ελαττώστε την ταχύτητα προώθησης της συγκόλλησης.
- » Χρησιμοποιείτε αέρια κατάλληλα για τα προς συγκόλληση υλικά.

Οξειδώσεις
Αιτία

- » Ανεπαρκής προστασία του αερίου.

Λύση

- » Ρυθμίστε σωστά τη ροή αερίου.
- » Βεβαιωθείτε ότι το στόμιο και το μπεκ αερίου της τσιμπίδας βρίσκονται σε καλή κατάσταση.

Πόροι
Αιτία

- » Γράσο, βερνίκι, σκουριά ή βρωμιά στα προς συγκόλληση κομμάτια.
- » Γράσο, βερνίκι, σκουριά ή βρωμιά στο υλικό συγκόλλησης (κόλληση).
- » Υγρασία στο υλικό συγκόλλησης (κόλληση).
- » Λανθασμένο μήκος τόξου.
- » Υγρασία στο αέριο συγκόλλησης.

Λύση

- » Καθαρίστε καλά τα κομμάτια, πριν τη συγκόλληση.
- » Χρησιμοποιείτε πάντοτε προϊόντα και υλικά καλής ποιότητας.
- » Διατηρείτε πάντοτε σε τέλεια κατάσταση το υλικό συγκόλλησης (κόλληση).
- » Χρησιμοποιείτε πάντοτε προϊόντα και υλικά καλής ποιότητας.
- » Διατηρείτε πάντοτε σε τέλεια κατάσταση το υλικό συγκόλλησης (κόλληση).
- » Μειώστε την απόσταση μεταξύ ηλεκτροδίου και τεμαχίου.
- » Μειώστε την τάση συγκόλλησης.
- » Χρησιμοποιείτε πάντοτε προϊόντα και υλικά καλής ποιότητας.
- » Διατηρείτε σε άριστη κατάσταση τη διάταξη τροφοδοσίας αερίου.

» Ανεπαρκής προστασία του αερίου.

» Ρυθμίστε σωστά τη ροή αερίου.

» Βεβαιωθείτε ότι το στόμιο και το μπεκ αερίου της τσιμπίδας βρίσκονται σε καλή κατάσταση.

» Πολύ γρήγορη στερεοποίηση του λουτρού συγκόλλησης.

» Ελαττώστε την ταχύτητα προώθησης της συγκόλλησης.

» Προθερμαίνετε τα προς συγκόλληση κομμάτια.

» Αυξήστε το ρεύμα συγκόλλησης.

Ρωγμές εν θερμώ

Αιτία

» Λανθασμένες παράμετροι συγκόλλησης.

» Γράσο, βερνίκι, σκουριά ή βρωμιά στα προς συγκόλληση κομμάτια.

» Γράσο, βερνίκι, σκουριά ή βρωμιά στο υλικό συγκόλλησης (κόλληση).

» Λανθασμένος τρόπος εκτέλεσης συγκόλλησης.

» Τα προς συγκόλληση κομμάτια έχουν διαφορετικά χαρακτηριστικά.

Λύση

» Ελαττώστε το ρεύμα συγκόλλησης.

» Χρησιμοποιήστε ηλεκτρόδιο με μικρότερη διάμετρο.

» Καθαρίστε καλά τα κομμάτια, πριν τη συγκόλληση.

» Χρησιμοποιείτε πάντοτε προϊόντα και υλικά καλής ποιότητας.

» Διατηρείτε πάντοτε σε τέλεια κατάσταση το υλικό συγκόλλησης (κόλληση).

» Εφαρμόστε την κατάλληλη διαδικασία, για τον τύπο του προς συγκόλληση συνδέσμου.

» Επαλείψτε πάστα ή λίπος, πριν τη συγκόλληση.

Ρωγμές εν ψυχρώ

Αιτία

» Υγρασία στο υλικό συγκόλλησης (κόλληση).

» Ιδιαίτερη γεωμετρική μορφή του προς συγκόλληση συνδέσμου.

Λύση

» Χρησιμοποιείτε πάντοτε προϊόντα και υλικά καλής ποιότητας.

» Διατηρείτε πάντοτε σε τέλεια κατάσταση το υλικό συγκόλλησης (κόλληση).

» Προθερμαίνετε τα προς συγκόλληση κομμάτια.

» Θέρμανση μετά τη συγκόλληση/κοπή.

» Εφαρμόστε την κατάλληλη διαδικασία, για τον τύπο του προς συγκόλληση συνδέσμου.

9. ΟΔΗΓΙΕΣ ΧΡΗΣΗΣ

9.1 Συγκόλληση με επενδυμένο ηλεκτρόδιο (MMA)

Προετοιμασία των άκρων

Για την επίτευξη σωστής συγκόλλησης, είναι πάντοτε σκόπιμο τα άκρα να είναι καθαρά, χωρίς οξειδία, σκουριά ή άλλους ρυπαρόνους παράγοντες.

Επιλογή του ηλεκτροδίου

Η διάμετρος του ηλεκτροδίου που θα χρησιμοποιηθεί εξαρτάται από το πάχος του υλικού, τη θέση, τον τύπο της σύνδεσης και τον τύπο του διάκενου.

Τα ηλεκτρόδια μεγάλης διαμέτρου απαιτούν υψηλά ρεύματα και, κατά συνέπεια, υψηλή θερμική παροχή στη συγκόλληση.

Τύπος επένδυσης	Χαρακτηριστικά	Χρήση
Ρουτιλίου	Ευκολία χρήσης	Όλες οι θέσεις
Όξινη	Υψηλή ταχύτητα τήξης	Επίπεδο
Βασικό	Μηχανικά χαρακτηριστικά	Όλες οι θέσεις

Επιλογή ρεύματος συγκόλλησης

Το εύρος των τιμών ρεύματος συγκόλλησης του κάθε τύπου χρησιμοποιούμενου ηλεκτροδίου επισημαίνεται από τον κατασκευαστή πάνω στη συσκευασία των ηλεκτροδίων.

Έναυση και διατήρηση τόξου

Το ηλεκτρικό τόξο παράγεται τρίβοντας το άκρο του ηλεκτροδίου πάνω στο προς συγκόλληση κομμάτι, στο οποίο είναι συνδεδεμένο το σώμα γείωσης. Μετά τη έναυση του τόξου, η τσιμπίδα απομακρύνεται, στην κανονική απόσταση συγκόλλησης.

Για να ευνοηθεί η έναυση του τόξου, πρέπει, στην αρχή, να δοθεί μία μεγαλύτερη ποσότητα ρεύματος, σε σχέση με το κανονικό ρεύμα συγκόλλησης (Hot Start).

Αφού σταθεροποιηθεί το ηλεκτρικό τόξο, αρχίζει η τήξη του κεντρικού τμήματος του ηλεκτροδίου, που εναποτίθεται υπό μορφή σταγόνων πάνω στο συγκολλούμενο κομμάτι.

Η εξωτερική επένδυση του ηλεκτροδίου, ενώ καταναλώνεται, παρέχει το αέριο που προστατεύει τη συγκόλληση και, συνεπώς, την καλή ποιότητά της.

Για να αποφευχθεί το σβήσιμο του τόξου από τις σταγόνες του λειωμένου υλικού, που βραχυκυκλώνουν το ηλεκτρόδιο με το λουτρό συγκόλλησης, εξαιτίας της κατά λάθος προσέγγισης αυτών των δύο, είναι πολύ χρήσιμη μία στιγμιαία αύξηση του ρεύματος συγκόλλησης, έως ότου ξεπεραστεί το βραχυκύκλωμα (Arc Force).

Σε περίπτωση που το ηλεκτρόδιο παραμείνει κολλημένο στο συγκολλούμενο κομμάτι, πρέπει να μειωθεί στο ελάχιστο το ρεύμα βραχυκυκλώματος (anti-sticking).

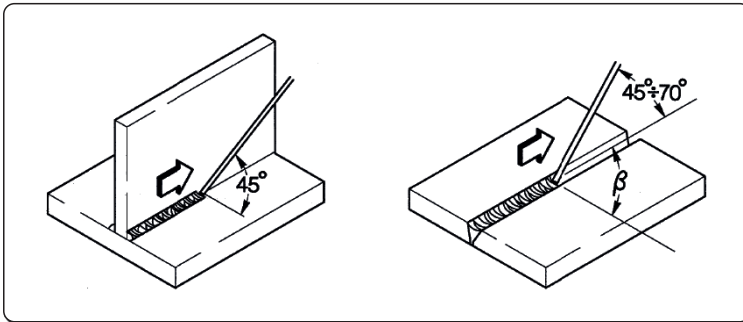

Εκτέλεση της συγκόλλησης

Η γωνία κλίσης του ηλεκτροδίου ποικίλει ανάλογα με τον αριθμό των περασμάτων. Η κίνηση του ηλεκτροδίου είναι συνήθως παλινδρομική και με στάσεις στα πλευρικά άκρα της ραφής, έτσι ώστε να αποφεύγεται η υπερβολική συσσώρευση υλικού συγκόλλησης στο κέντρο.

Αφαίρεση της σκουριάς

Στη συγκόλληση με επενδυμένα ηλεκτρόδια, μετά από κάθε πέρασμα, πρέπει να αφαιρείται η επικαλυπτική σκουριά. Η αφαίρεση γίνεται με μικρή σφυρί (ματσακόνι) ή με συρματόβουρτσα, όταν η σκουριά είναι ψαθυρή.

9.2 Συγκόλληση TIG (συνεχές τόξο)

Περιγραφή

Η συγκόλληση TIG (Tungsten Inert Gas) βασίζεται στην αρχή της δημιουργίας ενός ηλεκτρικού τόξου μεταξύ ενός άηκτου ηλεκτροδίου (καθαρό βολφράμιο ή κράμα, με θερμοκρασία τήξης περίπου 3370°C) και του μεταλλικού κομματιού. Ένα αδρανές αέριο (Αργό) προστατεύει το λουτρό συγκόλλησης.

Για να αποφευχθούν οι επικίνδυνοι εγκλωβισμοί βολφραμίου στη ραφή, το ηλεκτρόδιο δεν πρέπει να έρχεται ποτέ σε επαφή με το προς συγκόλληση κομμάτι. Για το λόγο αυτό, μέσω μιας γεννήτριας υψηλής συχνότητας (H.F.), δημιουργείται μια εκκένωση, που επιτρέπει την έναυση του ηλεκτρικού τόξου από απόσταση.

Υπάρχει και άλλος τύπος έναυσης, με περιορισμένους εγκλωβισμούς βολφραμίου: η έναυση lift, που δεν προβλέπει υψηλή συχνότητα, αλλά μία αρχική κατάσταση βραχυκυκλώματος με χαμηλό ρεύμα, μεταξύ ηλεκτροδίου και τεμαχίου. Τη στιγμή που απομακρύνεται το ηλεκτρόδιο, δημιουργείται το τόξο και το ρεύμα αυξάνει ως την επιλεγμένη τιμή.

Για να βελτιωθεί η ποιότητα του τελικού μέρους της ραφής συγκόλλησης, είναι χρήσιμο να μπορεί να ελεγχθεί με ακρίβεια η σταδιακή ελάττωση του ρεύματος συγκόλλησης και πρέπει απαραίτητα το αέριο να ρέει μέσα στο λουτρό συγκόλλησης, για μερικά δευτερόλεπτα ακόμη, μετά τη λήξη του τόξου.

Σε πολλές εργασίες, είναι χρήσιμη η ύπαρξη 2 διαφορετικών προκαθορισμένων ρευμάτων συγκόλλησης και η δυνατότητα εύκολης μετάβασης από το ένα στο άλλο (BILEVEL).

Πολικότητα συγκόλλησης

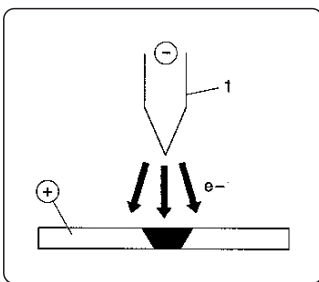

D.C.S.P. (Direct Current Straight Polarity)

Είναι η συνηθέστερη πολικότητα (άμεση ή κανονική πολικότητα) και επιτρέπει περιορισμένη φθορά του ηλεκτροδίου (1), εφόσον το 70% της θερμότητας συγκεντρώνεται στην άνοδο (συγκολλούμενο κομμάτι).

Επιτυγχάνονται στενά και βαθιά λουτρά, με υψηλές ταχύτητες πρόωσης και, κατά συνέπεια, χαμηλή θερμική παροχή.

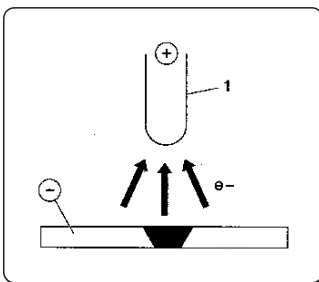

D.C.R.P. (Direct Current Reverse Polarity)

Η πολικότητα είναι ανάστροφη και επιτρέπει τη συγκόλληση κραμάτων που καλύπτονται από στρώμα αδρανούς οξειδίου με θερμοκρασία τήξης μεγαλύτερη από αυτή του μετάλλου.

Δεν μπορούν να χρησιμοποιηθούν υψηλά ρεύματα, γιατί προκαλούν υπερβολική φθορά του ηλεκτροδίου.

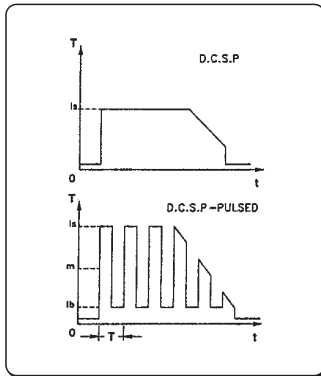

D.C.S.P.-Pulsed (Direct Current Straight Polarity Pulsed)

Η χρήση ενός συνεχούς παλμικού ρεύματος επιτρέπει τον καλύτερο έλεγχο του λουτρού συγκόλλησης σε ειδικές συνθήκες εργασίας.

Το λουτρό συγκόλλησης σχηματίζεται από τους παλμούς αιχμής (I_p), ενώ το βασικό ρεύμα (I_b) διατηρεί το τόξο αναμμένο. Αυτό διευκολύνει τη συγκόλληση κομματιών μικρού πάχους, με μικρότερη παραμόρφωση, καλύτερο συντελεστή μορφής και, συνεπώς, μικρότερο κίνδυνο ρηγματώσεων εν θερμώ και εγκλωβισμών αερίου.

Με την αύξηση της συχνότητας (μεσαία συχνότητα) επιτυγχάνεται ένα τόξο πιο στενό, πιο συγκεντρωμένο και πιο σταθερό και μια μεγαλύτερη ποιότητα της συγκόλλησης κομματιών μικρού πάχους.

Χαρακτηριστικά των συγκολλήσεων TIG

Η διαδικασία TIG είναι πολύ αποτελεσματική στη συγκόλληση, τόσο του κοινού, όσο και του εμπλουτισμένου με άνθρακα χάλυβα, για το πρώτο πέρασμα σε σωλήνες και για συγκολλήσεις που απαιτούν άριστη αισθητική εμφάνιση.

Απαιτείται η άμεση (κανονική) πολικότητα (D.C.S.P.).

Προετοιμασία των άκρων

Η διαδικασία απαιτεί τον προσεκτικό καθαρισμό και την προετοιμασία των άκρων.

Επιλογή και προετοιμασία του ηλεκτροδίου

Συνιστάται η χρήση ηλεκτροδίων βολφραμίου με θόριο (2% θόριο, κόκκινου χρώματος) ή εναλλακτικά ηλεκτρόδια Δημητρίου ή Λανθανίου με τις εξής διαμέτρους:

Εύρος ρεύματος			Ηλεκτροδίου	
(DC-)	(DC+)	(AC)	∅	α
3-20 A	-	3-20 A	0,5 mm	30°
15-80 A	-	20-30 A	1,0 mm	30-60°
70-150 A	10-20 A	30-80 A	1,6 mm	60-90°
150-250 A	15-30 A	60-130 A	2,4 mm	90-120°
250-400 A	25-40 A	100-180 A	3,2 mm	120-150°
400-500 A	40-55 A	160-240 A	4,0 mm	150-180°
500-750 A	55-80 A	190-300 A	4,8 mm	150-180°
750-1100 A	80-125 A	325-450 A	6,4 mm	150-180°

Η αιχμή του ηλεκτροδίου πρέπει να τροχίζεται όπως στην εικόνα.

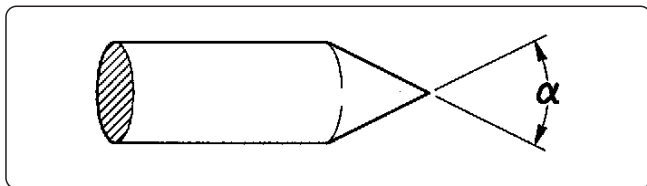

Υλικό συγκόλλησης (κόλληση)

Οι ράβδοι συγκολλητικού υλικού (κόλλησης) πρέπει να έχουν μηχανικές ιδιότητες παρόμοιες με αυτές της βάσης (κομματιού).

Σας συνιστούμε να μη χρησιμοποιείτε ράβδους που προέρχονται από το υλικό της βάσης (κομματιού), γιατί μπορεί να περιέχουν ακαθαρσίες από την κατεργασία και να έχουν αρνητικές συνέπειες στη συγκόλληση.

Προστατευτικό αέριο

Σχεδόν πάντοτε χρησιμοποιείται το καθαρό Αργό (99,99%).

Εύρος ρεύματος			Αέριο	
(DC-)	(DC+)	(AC)	Στόμιο	Ροή
3-20 A	-	3-20 A	n° 4	5-6 l/min
15-80 A	-	20-30 A	n° 5	6-8 l/min
70-150 A	10-20 A	30-80 A	n° 6	7-10 l/min
150-250 A	15-30 A	60-130 A	n° 7	8-12 l/min
250-400 A	25-40 A	100-180 A	n° 8	10-14 l/min

Εύρος ρεύματος			Αέριο	
400-500 A	40-55 A	160-240 A	n° 8	12-16 l/min
500-750 A	55-80 A	190-300 A	n° 10	15-20 l/min
750-1100 A	80-125 A	325-450 A	n° 12	20-25 l/min

10. ΤΕΧΝΙΚΑ ΧΑΡΑΚΤΗΡΙΣΤΙΚΑ

Ηλεκτρικά Χαρακτηριστικά			U.M.
Τάση τροφοδοσίας U1 (50/60 Hz)	3x230 (±15%)	3x400 (±15%)	Vac
Zmax (@PCC) *	53	53	mΩ
Ασφάλεια γραμμής με καθυστέρηση	25	16	A
Τύπος επικοινωνίας	ΨΗΦΙΑΚΟΣ	ΨΗΦΙΑΚΟΣ	
Μέγ. απορροφούμενη ισχύς	10.5	10.5	kVA
Μέγ. απορροφούμενη ισχύς	10.1	10.1	kW
Απορρόφηση ισχύος σε ανενεργή κατάσταση	51	51	W
Συντελεστής ισχύος (PF)	0.96	0.96	
Απόδοση (μ)	83	83	%
Cos φ	0.99	0.99	
Μέγιστη απορρόφηση ρεύματος I1max	30.8	15.3	A
Πραγματικό ρεύμα I1eff	18	9	A
Εύρος ρυθμίσεων	3-270	3-270	A
Τάση εν κενώ Uo	80	80	Vdc
Τάση αιχμής Up	10.1	10.1	kV

* Αυτή η συσκευή πληροί τις απαιτήσεις του προτύπου EN / IEC 61000-3-11.

* Αυτή η συσκευή πληροί τις απαιτήσεις του προτύπου EN / IEC 61000-3-12, αν η μέγιστη επιτρεπόμενη εμπέδηση δικτύου στο σημείο διεπαφής με το δημόσιο δίκτυο (σημείο Κοινής σύνδεσης, ΣΚΣ - point of common coupling, PCC) είναι χαμηλότερη ή ίση με την αναφερόμενη τιμή "Zmax". Αν η συσκευή είναι συνδεδεμένη στο δημόσιο δίκτυο παροχής χαμηλής τάσης, ο εγκαταστάτης ή ο χρήστης έχουν την υποχρέωση να εξακριβώσουν (συμβουλευόμενοι ενδεχομένως τον διαχειριστή του ηλεκτρικού δικτύου) αν η συσκευή μπορεί να συνδεθεί.

Συντελεστής χρήσης	3x230V	3x400V	U.M.
Συντελεστής χρήσης (40°C)			
(X=35%)	270	270	A
(X=60%)	230	230	A
(X=100%)	180	180	A
Συντελεστής χρήσης (25°C)			
(X=80%)	270	270	A
(X=100%)	240	240	A

Φυσικά χαρακτηριστικά			U.M.
Βαθμός προστασίας IP	IP23S		
Κλάση μόνωσης	H		
Διαστάσεις (ΠxΒxΥ)	500x190x400		mm
Βάρος	18.8		Kg
Παράγραφο καλώδιο τροφοδοσίας	4x4		mm ²
Μήκος καλωδίου τροφοδοσίας	5		m
Πρότυπα κατασκευής	EN IEC 60974-1/A1:2019 EN IEC 60974-3:2019 EN 60974-10/A1:2015		

11. ΠΙΝΑΚΪΔΑ ΧΑΡΑΚΤΗΡΙΣΤΙΚΩΝ

VOESTALPINE BÖHLER WELDING SELCO S.R.L. Via Palladio, 19 - ONARA (PADOVA) - ITALY				
URANOS NX 2700 TLH		N°		
EN 60974-1/A1:2019 IEC 60974-10/A1:2015 Class A		60974-3:2019		
U ₀ 80V	U _p 10.1 kV			
	3A/10.0V - 270A (270A)/20.8V (20.8V)			
U ₀ 80V	X(40°C)	35%	60%	100%
	I ₂	270A (270A)	230A (230A)	180A (180A)
U ₀ 80V	U ₂	20.8V (20.8V)	19.2V (19.2V)	17.2V (17.2V)
	3A/20.0V - 270A (270A)/30.8V (30.8V)			
U ₀ 80V	X(40°C)	35%	60%	100%
	I ₂	270A (270A)	230A (230A)	180A (180A)
U ₀ 80V	U ₂	30.8V (30.8V)	29.2V (29.2V)	27.2V (27.2V)
	U ₁ 400V(230V)	I _{1max} 15.3A(30.8A)	I _{1eff} 9A(18A)	
IP 23 S				

12. ΣΗΜΑΣΪΑ ΠΙΝΑΚΪΔΑΣ ΧΑΡΑΚΤΗΡΙΩΤΙΚΩΝ

1		2			
3		4			
5	6				
7	9	23			
		11			
8	10	12	15	16	17
		13	15A	16A	17A
		14	15B	16B	17B
7	9	11			
		12	15	16	17
8	10	13	15A	16A	17A
		14	15B	16B	17B
		18		19	20
22					

CE Δήλωση συμμόρφωσης EE
 EAC Δήλωση συμμόρφωσης EAC
 UKCA Δήλωση συμμόρφωσης UKCA

- 1 Σήμα κατασκευαστή
- 2 Επωνυμία και διεύθυνση κατασκευαστή
- 3 Μοντέλο συσκευής
- 4 Αριθ. σειράς
XXXXXXXXXX Έτος κατασκευής
- 5 Σύμβολο τύπου μηχανής συγκόλλησης
- 6 Παραπομπή στα πρότυπα κατασκευής
- 7 Σύμβολο διαδικασίας συγκόλλησης
- 8 Σύμβολο μηχανών συγκόλλησης για λειτουργία σε περιβάλλον με αυξημένο κίνδυνο ηλεκτροπληξίας
- 9 Σύμβολο ρεύματος συγκόλλησης
- 10 Ονομαστική τάση χωρίς φορτίο
- 11 Εύρος μέγιστου και ελάχιστου ονομαστικού ρεύματος συγκόλλησης και αντίστοιχης συμβατικής τάσης φόρτωσης
- 12 Σύμβολο κύκλου διακοπτόμενης λειτουργίας
- 13 Σύμβολο ονομαστικού ρεύματος συγκόλλησης
- 14 Σύμβολο ονομαστικής τάσης συγκόλλησης
- 15 Τιμές κύκλου διακοπτόμενης λειτουργίας
- 16 Τιμές κύκλου διακοπτόμενης λειτουργίας
- 17 Τιμές κύκλου διακοπτόμενης λειτουργίας
- 15A Τιμές ονομαστικού ρεύματος συγκόλλησης
- 16A Τιμές ονομαστικού ρεύματος συγκόλλησης
- 17A Τιμές ονομαστικού ρεύματος συγκόλλησης
- 15B Τιμές συμβατικής τάσης φόρτωσης
- 16B Τιμές συμβατικής τάσης φόρτωσης
- 17B Τιμές συμβατικής τάσης φόρτωσης
- 18 Σύμβολο τροφοδοσίας
- 19 Ονομαστική τάση τροφοδοσίας
- 20 Μέγιστο ονομαστικό ρεύμα τροφοδοσίας
- 21 Μέγιστο αποτελεσματικό ρεύμα τροφοδοσίας
- 22 Βαθμός προστασίας
- 23 Ονομαστική τάση αιχμής

13. SCHEMA, DIAGRAM, SCHALTPLAN, SCHEMA, ESQUEMA, DIAGRAMA, SCHEMA, KOPPLINGSSCHEMA, OVERSICHT, SKJEMA, KYTKENTÄKAAVIO, ΔΙΑΓΡΑΜΜΑ

URANOS NX 2700 TLH 3x230V 3x400V (55.07.043)

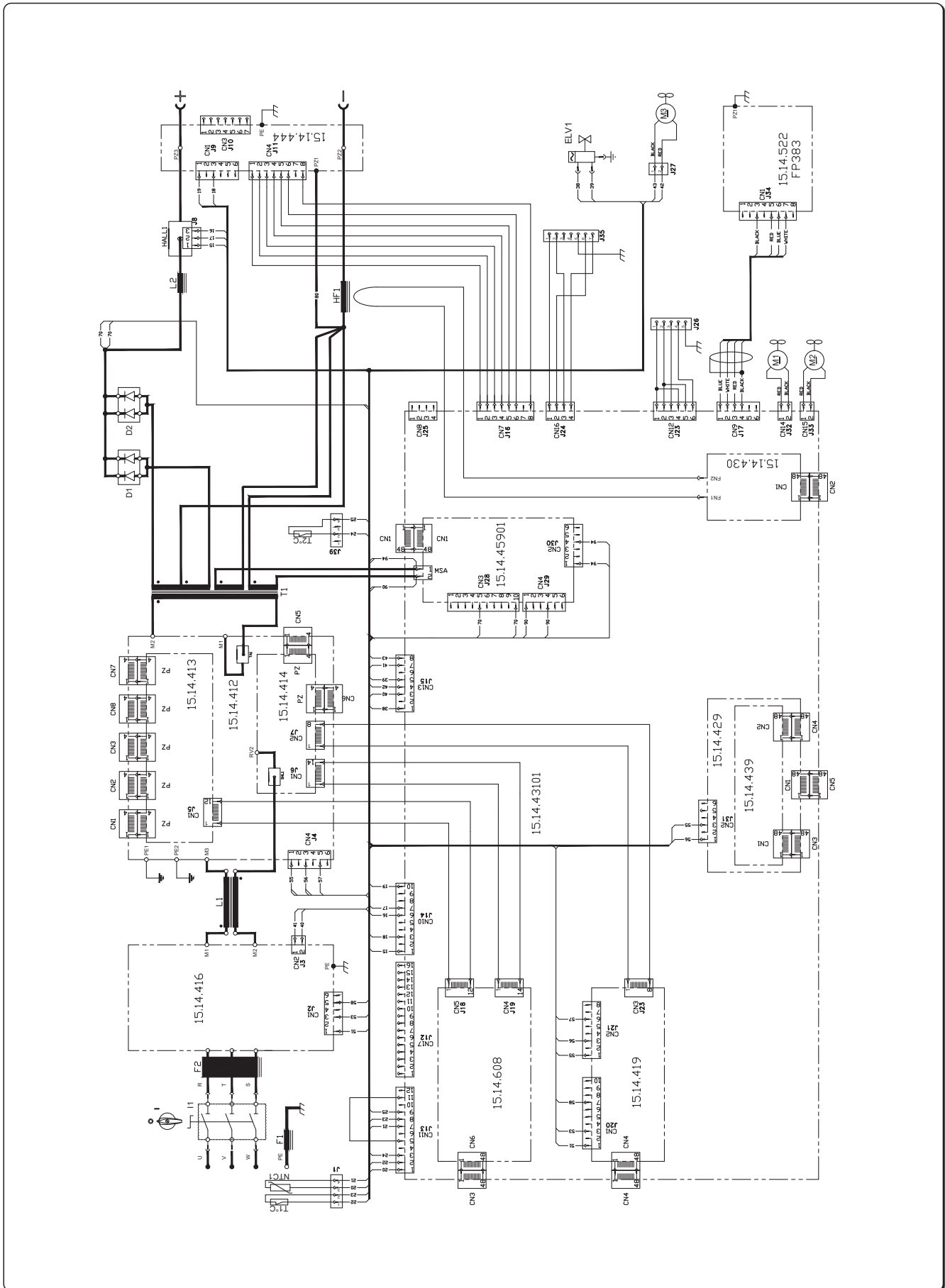

URANOS NX 2700 TLH 3x230V 3x400V LCD 3.5" (55.07.042)

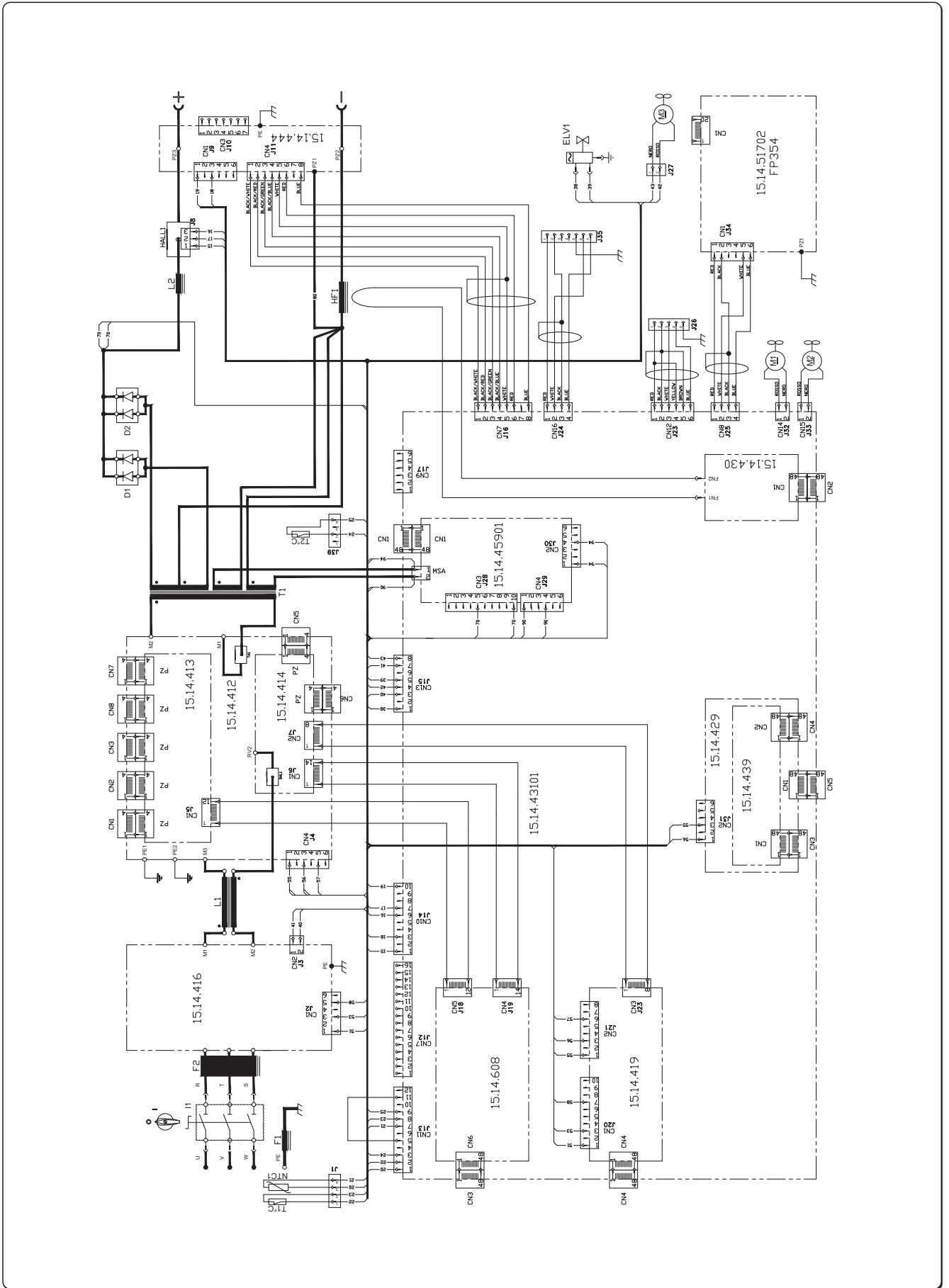

14. CONNETTORI, CONNECTORS, VERBINDER, CONNECTEURS, CONECTORES, CONECTORES, VERBINDINGEN, KONTAKTDON, KONNEKTORER, SKJØTEMUNNSTYKKER, LIITTIMET, ΣΥΝΔΕΤΗΡΕΣ

URANOS NX 2700 TLH 3x230V 3x400V (55.07.043)

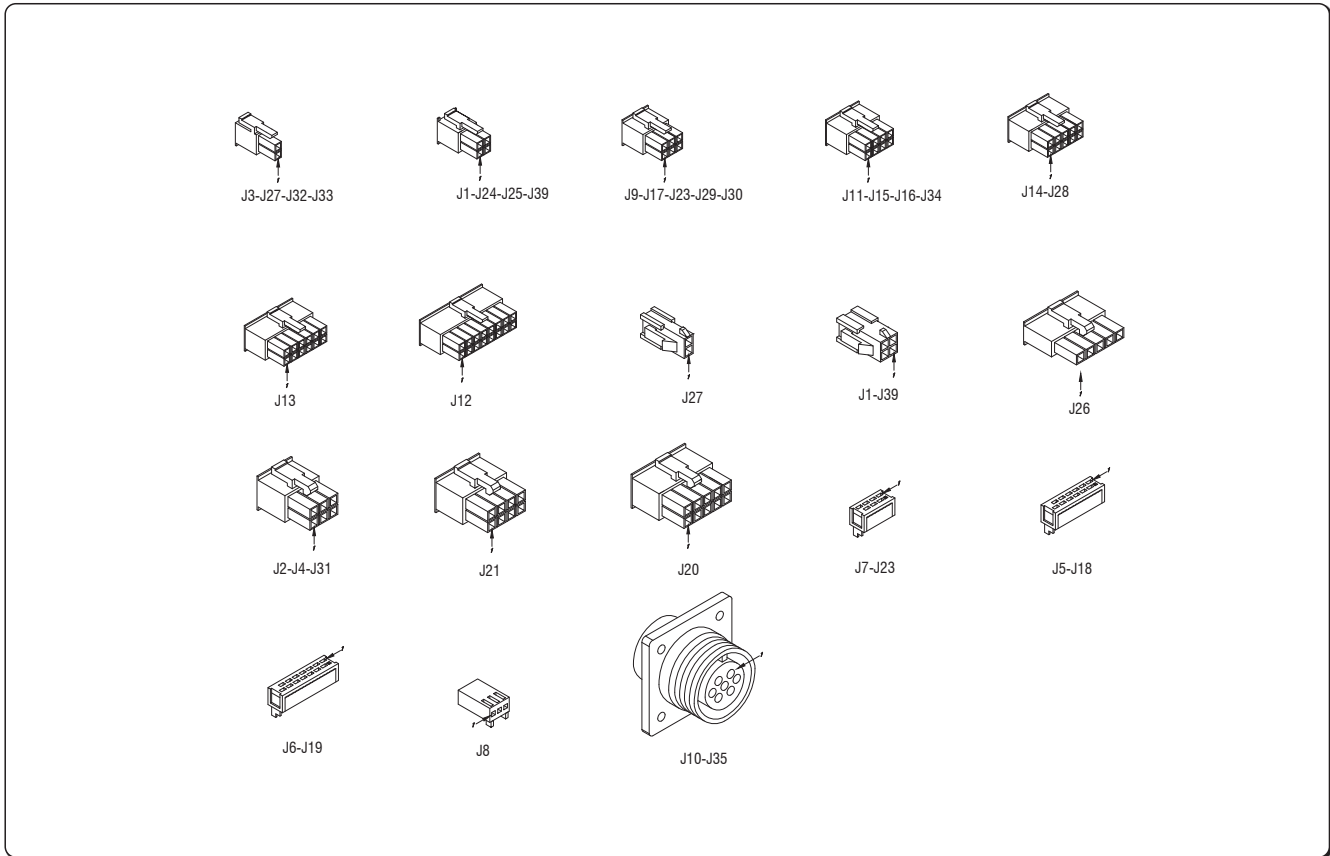

URANOS NX 2700 TLH 3x230V 3x400V LCD 3.5" (55.07.042)

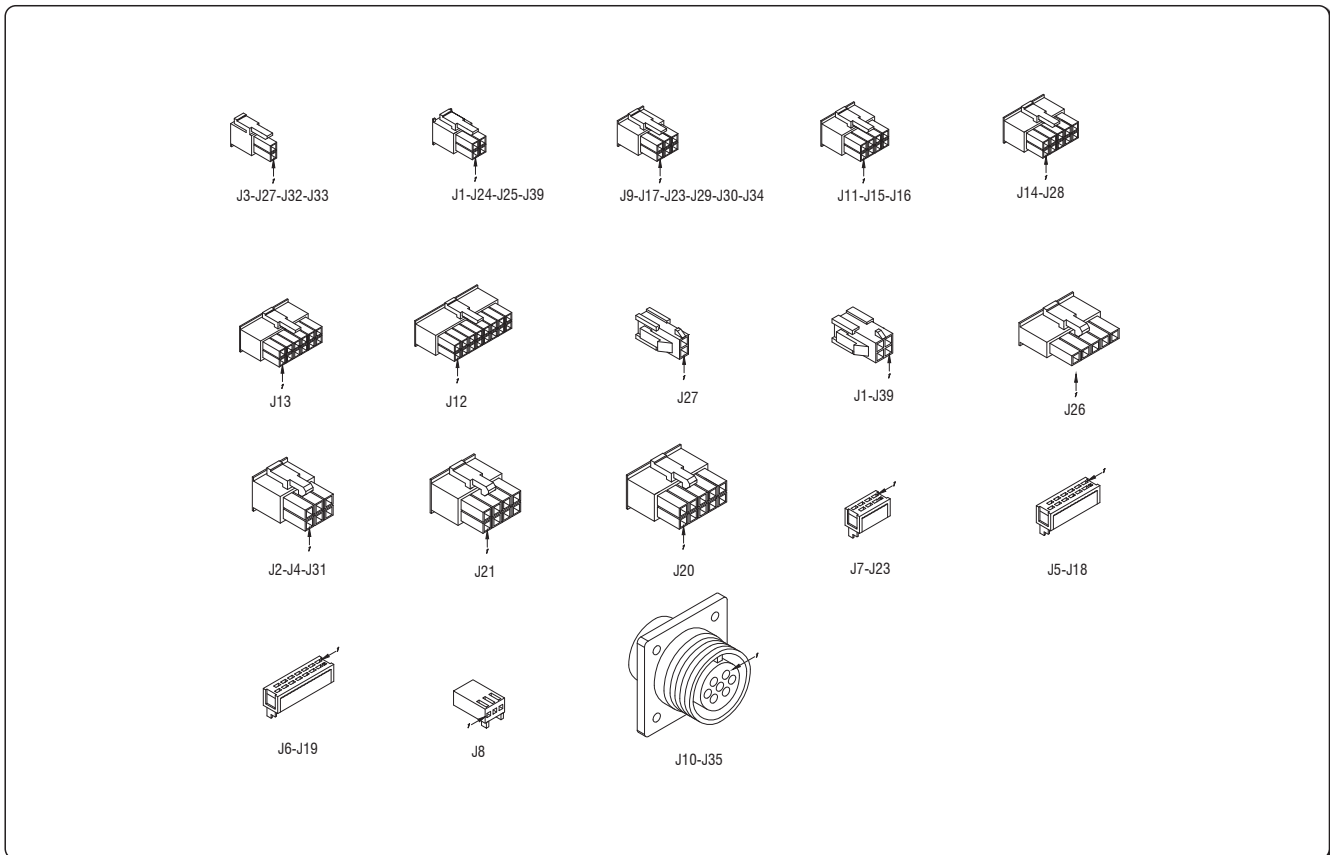

CODE	ITALIANO	ENGLISH	DEUTSCH	FRANÇAIS	ESPAÑOL
01.02.15401	Cofano superiore	Metal cover upper	Oberes gehäuse	Carter supérieur	Chapa superior
01.02.15502	Cofano inferiore	Metal cover lower	Unteres gehäuse	Carter inférieur	Chapa inferior
01.06.02707	Coperchio	Cover	Abdeckung	Couverture	Cubierta
01.15.052	Manico	Handle	Griff	Manche	Mango
03.05.46001	Profilo prese	Profile	Profil	Profil	Perfil
03.05.482	Targa posteriore	Rearnameplate	Hinterschild	Plaque arrière	Placa posterior
03.07.594	Pannello laterale DX	Side panel - RIGHT	Seitenpaneel - RE	Panneau latéral droit	Panel lateral dcho
03.07.595	Pannello laterale SX	Side panel - LEFT	Seitenpaneel - LI	Panneau latéral gauche	Panel lateralizado
05.02.033	Trasformatore inverter	Power transformer	Invertertransformator	Transformateur onduleur	Transformador inverter
05.03.022	Trasformatore H.F.	H.F. transformer	H.F. transformator	Transformateur H.F.	Transformador H.F.
05.04.235	Induttanza di livellamento	Output choke	Induktanz	Inductance de sortie	Inductancia de salida
05.18.006	Induttanza	Choke	Induktanz	Inductance	Inductancia
08.22.012	Pressacavo	Cable clamp	Kabelklemme	Serre-câble	Racor para cable
09.01.011	Interruttore tripolare	Switch - 3 poles	Dreipoliger schalter	Interrupteur tripolaire	Interruptor tripolar
09.05.001	Elettrovalvola	Solenoid valve	Magnetventil	Électrovanne	Electroválvula
09.07.909	Sensore termico	Thermal sensor	Wärmefühler	Capteur thermique	Sensor térmico
09.07.917	Sensore termico	Thermal sensor	Wärmefühler	Capteur thermique	Sensor térmico
09.11.009	Manopola	Knob	Drehknopf	Bouton	Empuñadura
10.01.155	Tappo connettore	Screw cap	Verbinderstopfen	Bouchon connecteur	Tapón conector
10.05.035	Connettore 7 contatti	7 pins connector	7-polige kupplung	Connecteur 7 contacts	Conector 7 polos
10.13.023	Presafissa 70-95mm ²	Current socket (panel) 70-95mm ²	Feste steckdose 70-95mm ²	Prise fixe 70-95 mm ²	Base conector 70-95mm ²
11.19.013	Sensore corrente 300A	Current sensor - 300A	Stromsensor 300A	Capteur courant 300A	Sensor corriente 300A
14.05.026	Modulo diodi	Diode module	Diode modul	Module diodes	Módulo diodos
14.70.050	Ventilatore	Fan	Ventilator	Ventilateur	Ventilador
14.70.052	Ventilatore	Fan	Ventilator	Ventilateur	Ventilador
15.14.4163	Scheda elettronica	P.C. Board	Elektronische platine	Platine électronique	Tarjeta electrónica
15.14.4196	Scheda elettronica	P.C. Board	Elektronische platine	Platine électronique	Tarjeta electrónica
15.14.4307	Scheda elettronica	P.C. Board	Elektronische platine	Platine électronique	Tarjeta electrónica
15.14.4443	Scheda elettronica	P.C. Board	Elektronische platine	Platine électronique	Tarjeta electrónica

CODE	ITALIANO	ENGLISH	DEUTSCH	FRANÇAIS	ESPAÑOL
15.14.45931	Scheda elettronica	P.C. Board	Elektronische platine	Platine électronique	Tarjeta electrónica
15.14.6082	Scheda elettronica	P.C. Board	Elektronische platine	Platine électronique	Tarjeta electrónica
15.18.03303	Kit scheda elettronica	P.C. Board - Spare kit	Platinensatz	Kit platines	Kit tarjetas
15.18.037	Kit scheda potenza	Power P.C. Board - Spare kit	Kit leistungskarte	Kit carte puissance	Kit tarjeta de potencia
15.22.354	Pannello comandi FP354	Control panel FP354	Bedienungsfeld FP354	Panneau commandes FP354	Panel mandos FP354
19.50.055	Raccordo 1/8"	Fitting 1/8"	Anschluss 1/8"	Raccord. 1/8"	Racor 1/8"
20.04.021	Tappo	Cap	Stopfen	Bouchon	Tapón
20.07.118	Supporto prese	Current socket holder	Steckdosenhalterung	Support prises	SopORTE toma eléctrica
24.01.190	Raccordo 1/8" - 1/4"	Fitting 1/8" - 1/4"	Anschluss 1/8" - 1/4"	Raccord. 1/8" - 1/4"	Racor 1/8" - 1/4"
49.04.075	Cavo alimentazione	Input line cord	Speisekabel	Cable d'alimentation	Cable alimentación
71.10.005	Tubo PVC retinato 5x11 - 1,70m	Braided PVC hose - 5x11 - 1,7m	Pvc-gewebeschlauch 5x11 - 1,70m	Tuyau PVC avec gaine de protection 5x11 - 1,70m	Manguera PVC con malla 5x11 - 1,70m
74.90.071	Kit plastiche	Plastic parts - Spare kit	Kit kunststoffteile	Kit parties en plastique	Kit partes plásticas externas
74.90.072	Kit plastiche	Plastic parts - Spare kit	Kit kunststoffteile	Kit parties en plastique	Kit partes plásticas externas
91.08.454	Manuale istruzioni: URANOS NX 2700 TLH [IT,EN,DE,FR,ES,PT,NL,S V,DA,NO,FI,EL]	Instruction manual: URANOS NX 2700 TLH [IT,EN,DE,FR,ES,PT,NL,S V,DA,NO,FI,EL]	Bedienungsanweisungen: URANOS NX 2700 TLH [IT,EN,DE,FR,ES,PT,NL,S V,DA,NO,FI,EL]	Manuel d'instructions: URANOS NX 2700 TLH [IT,EN,DE,FR,ES,PT,NL,S V,DA,NO,FI,EL]	Manual instrucciones: URANOS NX 2700 TLH [IT,EN,DE,FR,ES,PT,NL,S V,DA,NO,FI,EL]
91.08.455	Manuale istruzioni: URANOS NX 2700 TLH [CS,PL,RU,TR,RO,BG,SK,ET,LV,LT,HU,SL]	Instruction manual: URANOS NX 2700 TLH [CS,PL,RU,TR,RO,BG,SK,ET,LV,LT,HU,SL]	Bedienungsanweisungen: URANOS NX 2700 TLH [CS,PL,RU,TR,RO,BG,SK,ET,LV,LT,HU,SL]	Manuel d'instructions: URANOS NX 2700 TLH [CS,PL,RU,TR,RO,BG,SK,ET,LV,LT,HU,SL]	Manual instrucciones: URANOS NX 2700 TLH [CS,PL,RU,TR,RO,BG,SK,ET,LV,LT,HU,SL]

URANOS NX 2700 TLH 3x230V 3x400V (55.07.043)

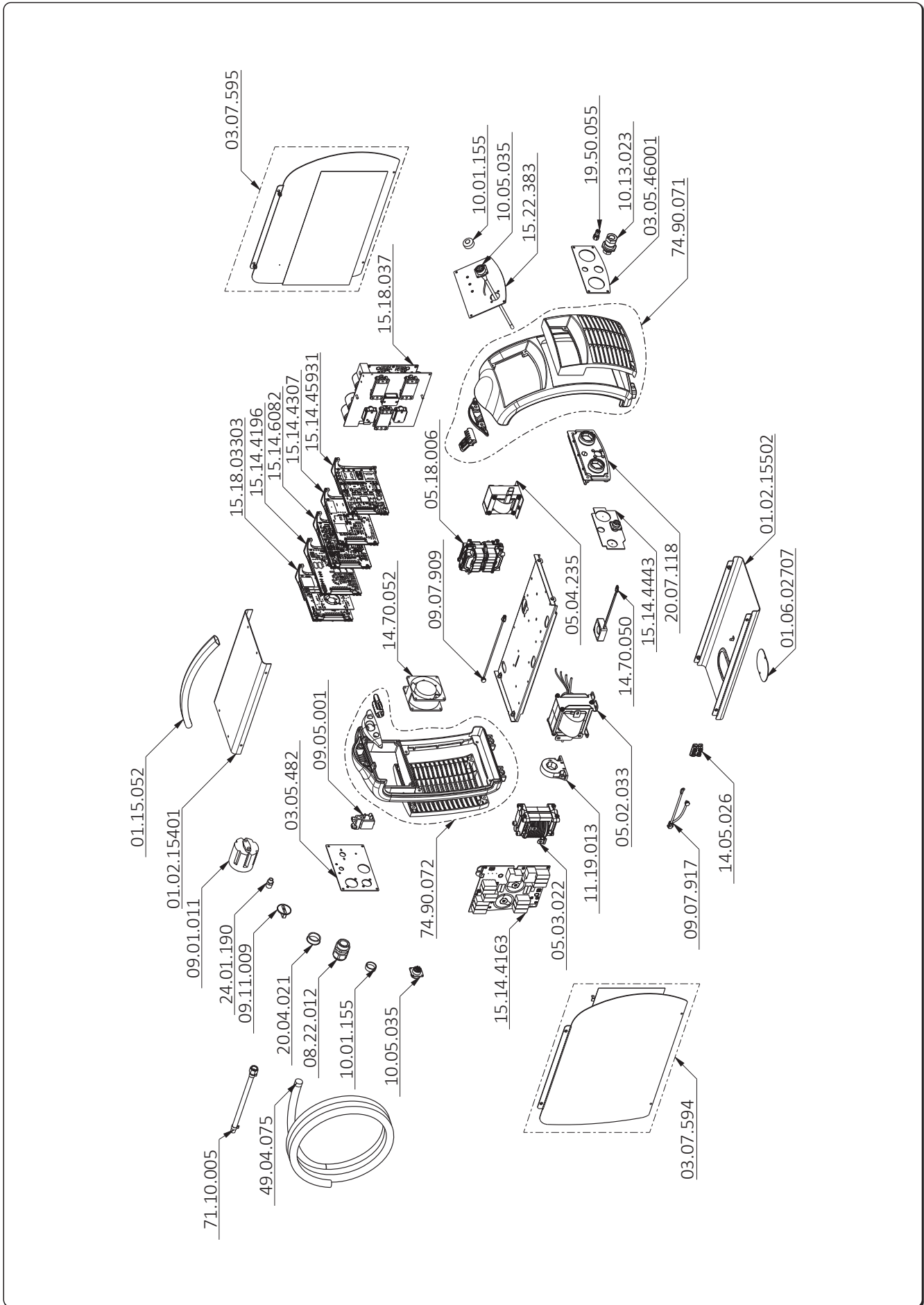

CODE	ITALIANO	ENGLISH	DEUTSCH	FRANÇAIS	ESPAÑOL
01.02.15.401	Cofano superiore	Metal cover upper	Oberes gehäuse	Carter supérieur	Chapa superior
01.02.15502	Cofano inferiore	Metal cover lower	Unteres gehäuse	Carter inférieur	Chapa inferior
01.06.02707	Coperchio	Cover	Abdeckung	Couverture	Cubierta
01.15.052	Manico	Handle	Griff	Manche	Mango
03.05.46001	Profilo prese	Profile	Profil	Profil	Perfil
03.05.482	Targa posteriore	Rear nameplate	Hinterschild	Plaque arrière	Placa posterior
03.07.594	Pannello laterale DX	Side panel - RIGHT	Seitenpaneel - RE	Panneau latéral droit	Panel lateral dcho
03.07.595	Pannello laterale SX	Side panel - LEFT	Seitenpaneel - LI	Panneau latéral gauche	Panel lateral izqdo
05.02.033	Trasformatore inverter	Power transformer	Invertertransformator	Transformateur onduleur	Transformador inverter
05.03.022	Trasformatore H.F.	H.F. transformer	H.F. transformator	Transformateur H.F.	Transformador H.F.
05.04.235	Induttanza di livellamento	Output choke	Induktanz	Inductance de sortie	Inductancia de salida
05.18.006	Induttanza	Choke	Induktanz	Inductance	Inductancia
08.22.012	Pressacavo	Cable clamp	Kabelklemme	Serre-câble	Racor para cable
09.01.011	Interruttore tripolare	Switch - 3 poles	Dreipoliger schalter	Interrupteur tripolaire	Interruptor tripolar
09.05.001	Elettrovalvola	Solenoid valve	Magnetventil	Électrovanne	Electrodivulva
09.07.909	Sensore termico	Thermal sensor	Wärmefühler	Capteur thermique	Sensor térmico
09.07.917	Sensore termico	Thermal sensor	Wärmefühler	Capteur thermique	Sensor térmico
09.11.009	Manopola	Knob	Drehknopf	Bouton	Empuñadura
10.01.155	Tappo connettore	Screw cap	Verbinderstopfen	Bouchon connecteur	Tapón conector
10.05.035	Connettore 7 contatti	7 pins connector	7-polige kupplung	Connecteur 7 contacts	Conector 7 polos
10.13.023	Presa fissa 70-95mm ²	Current socket (panel) 70-95mm ²	Feste steckdose 70-95mm ²	Prise fixe 70-95 mm ²	Base conector 70-95mm ²
11.19.013	Sensore corrente 300A	Current sensor - 300A	Stromsensor 300A	Capteur courant 300A	Sensor corriente 300A
14.05.026	Modulo diodi	Diode module	Diodenmodul	Module diodes	Módulo diodos
14.70.050	Ventilatore	Fan	Ventilator	Ventilateur	Ventilador
14.70.052	Ventilatore	Fan	Ventilator	Ventilateur	Ventilador
15.14.4163	Scheda elettronica	P.C. Board	Elektronische platine	Platine électronique	Tarjeta electrónica
15.14.4196	Scheda elettronica	P.C. Board	Elektronische platine	Platine électronique	Tarjeta electrónica
15.14.4307	Scheda elettronica	P.C. Board	Elektronische platine	Platine électronique	Tarjeta electrónica
15.14.4443	Scheda elettronica	P.C. Board	Elektronische platine	Platine électronique	Tarjeta electrónica

CODE	ITALIANO	ENGLISH	DEUTSCH	FRANÇAIS	ESPAÑOL
15.14.45931	Scheda elettronica	P.C. Board	Elektronische platine	Platine électronique	Tarjeta electrónica
15.14.6082	Scheda elettronica	P.C. Board	Elektronische platine	Platine électronique	Tarjeta electrónica
15.18.03303	Kit scheda elettronica	P.C. Board - Spare kit	Platinensatz	Kit platines	Kit tarjetas
15.18.037	Kit scheda potenza	Power P.C. Board - Spare kit	Kit leistungskarte	Kit carte puissance	Kit tarjeta de potencia
15.22.383	Pannello comandi FP383	Control panel FP383	Bedienungsfeld FP383	Panneau commandes FP383	Panel mandos FP383
19.50.055	Raccordo 1/8"	Fitting 1/8"	Anschluss 1/8"	Raccord. 1/8"	Racor 1/8"
20.04.021	Tappo	Cap	Stopfen	Bouchon	Tapón
20.07.118	Supporto prese	Current socket holder	Steckdosenhalterung	Support prises	Soporte toma eléctrica
24.01.190	Raccordo 1/8" - 1/4"	Fitting 1/8" - 1/4"	Anschluss 1/8" - 1/4"	Raccord. 1/8" - 1/4"	Racor 1/8" - 1/4"
49.04.075	Cavo alimentazione	Input line cord	Speisekabel	Cable d'alimentation	Cable alimentación
71.10.005	Tubo PVC retinato 5x11 - 1,70m	Braided PVC hose - 5x11 - 1,7m	Pvc-gewebeschlauch 5x11 - 1,70m	Tuyau PVC avec gaine de protection 5x11 - 1,70m	Manguera PVC con malla 5x11 - 1,70m
74.90.071	Kit plastiche	Plastic parts - Spare kit	Kit kunststoffteile	Kit parties en plastique	Kit partes plásticas externas
74.90.072	Kit plastiche	Plastic parts - Spare kit	Kit kunststoffteile	Kit parties en plastique	Kit partes plásticas externas
91.08.454	Manuale istruzioni: URANOS NX 2700 TLH [IT,EN,DE,FR,ES,PT,NL,SV,DA,NO,FI,EL]	Instruction manual: URANOS NX 2700 TLH [IT,EN,DE,FR,ES,PT,NL,SV,DA,NO,FI,EL]	Bedienungsanweisungen: URANOS NX 2700 TLH [IT,EN,DE,FR,ES,PT,NL,SV,DA,NO,FI,EL]	Manuel d'instructions: URANOS NX 2700 TLH [IT,EN,DE,FR,ES,PT,NL,SV,DA,NO,FI,EL]	Manual instrucciones: URANOS NX 2700 TLH [IT,EN,DE,FR,ES,PT,NL,SV,DA,NO,FI,EL]
91.08.455	Manuale istruzioni: URANOS NX 2700 TLH [CS,PL,RU,RO,BG,SK,ET,LT,HU,SL]	Instruction manual: URANOS NX 2700 TLH [CS,PL,RU,RO,BG,SK,ET,LT,HU,SL]	Bedienungsanweisungen: URANOS NX 2700 TLH [CS,PL,RU,RO,BG,SK,ET,LT,HU,SL]	Manuel d'instructions: URANOS NX 2700 TLH [CS,PL,RU,RO,BG,SK,ET,LT,HU,SL]	Manual instrucciones: URANOS NX 2700 TLH [CS,PL,RU,RO,BG,SK,ET,LT,HU,SL]

